

# **Handbook of Pharmaceutical Granulation Technology**

# DRUGS AND THE PHARMACEUTICAL SCIENCES

Executive Editor

**James Swarbrick**

*PharmaceuTech, Inc.  
Pinehurst, North Carolina*

## Advisory Board

Larry L. Augsburger  
*University of Maryland  
Baltimore, Maryland*

Harry G. Brittain  
*Center for Pharmaceutical Physics  
Milford, New Jersey*

Jennifer B. Dressman  
*Johann Wolfgang Goethe University  
Frankfurt, Germany*

Anthony J. Hickey  
*University of North Carolina School of  
Pharmacy  
Chapel Hill, North Carolina*

Jeffrey A. Hughes  
*University of Florida College of  
Pharmacy  
Gainesville, Florida*

Ajaz Hussain  
*U.S. Food and Drug Administration  
Frederick, Maryland*

Trevor M. Jones  
*The Association of the  
British Pharmaceutical Industry  
London, United Kingdom*

Hans E. Junginger  
*Leiden/Amsterdam Center  
for Drug Research  
Leiden, The Netherlands*

Vincent H. L. Lee  
*University of Southern California  
Los Angeles, California*

Stephen G. Schulman  
*University of Florida  
Gainesville, Florida*

Jerome P. Skelly  
*Alexandria, Virginia*

Elizabeth M. Topp  
*University of Kansas School of  
Pharmacy  
Lawrence, Kansas*

Geoffrey T. Tucker  
*University of Sheffield  
Royal Hallamshire Hospital  
Sheffield, United Kingdom*

Peter York  
*University of Bradford School of  
Pharmacy  
Bradford, United Kingdom*

# DRUGS AND THE PHARMACEUTICAL SCIENCES

A Series of Textbooks and Monographs

1. Pharmacokinetics, *Milo Gibaldi and Donald Perrier*
2. Good Manufacturing Practices for Pharmaceuticals: A Plan for Total Quality Control, *Sidney H. Willig, Murray M. Tuckerman, and William S. Hitchings IV*
3. Microencapsulation, *edited by J. R. Nixon*
4. Drug Metabolism: Chemical and Biochemical Aspects, *Bernard Testa and Peter Jenner*
5. New Drugs: Discovery and Development, *edited by Alan A. Rubin*
6. Sustained and Controlled Release Drug Delivery Systems, *edited by Joseph R. Robinson*
7. Modern Pharmaceutics, *edited by Gilbert S. Banker and Christopher T. Rhodes*
8. Prescription Drugs in Short Supply: Case Histories, *Michael A. Schwartz*
9. Activated Charcoal: Antidotal and Other Medical Uses, *David O. Cooney*
10. Concepts in Drug Metabolism (in two parts), *edited by Peter Jenner and Bernard Testa*
11. Pharmaceutical Analysis: Modern Methods (in two parts), *edited by James W. Munson*
12. Techniques of Solubilization of Drugs, *edited by Samuel H. Yalkowsky*
13. Orphan Drugs, *edited by Fred E. Karch*
14. Novel Drug Delivery Systems: Fundamentals, Developmental Concepts, Biomedical Assessments, *Yie W. Chien*
15. Pharmacokinetics: Second Edition, Revised and Expanded, *Milo Gibaldi and Donald Perrier*
16. Good Manufacturing Practices for Pharmaceuticals: A Plan for Total Quality Control, Second Edition, Revised and Expanded, *Sidney H. Willig, Murray M. Tuckerman, and William S. Hitchings IV*
17. Formulation of Veterinary Dosage Forms, *edited by Jack Blodinger*
18. Dermatological Formulations: Percutaneous Absorption, *Brian W. Barry*
19. The Clinical Research Process in the Pharmaceutical Industry, *edited by Gary M. Matoren*
20. Microencapsulation and Related Drug Processes, *Patrick B. Deasy*
21. Drugs and Nutrients: The Interactive Effects, *edited by Daphne A. Roe and T. Colin Campbell*
22. Biotechnology of Industrial Antibiotics, *Erick J. Vandamme*
23. Pharmaceutical Process Validation, *edited by Bernard T. Loftus and Robert A. Nash*

24. Anticancer and Interferon Agents: Synthesis and Properties, *edited by Raphael M. Ottenbrite and George B. Butler*
25. Pharmaceutical Statistics: Practical and Clinical Applications, *Sanford Bolton*
26. Drug Dynamics for Analytical, Clinical, and Biological Chemists, *Benjamin J. Gudzinowicz, Burrows T. Younkin, Jr., and Michael J. Gudzinowicz*
27. Modern Analysis of Antibiotics, *edited by Adjoran Aszalos*
28. Solubility and Related Properties, *Kenneth C. James*
29. Controlled Drug Delivery: Fundamentals and Applications, Second Edition, Revised and Expanded, *edited by Joseph R. Robinson and Vincent H. Lee*
30. New Drug Approval Process: Clinical and Regulatory Management, *edited by Richard A. Guarino*
31. Transdermal Controlled Systemic Medications, *edited by Yie W. Chien*
32. Drug Delivery Devices: Fundamentals and Applications, *edited by Praveen Tyle*
33. Pharmacokinetics: Regulatory • Industrial • Academic Perspectives, *edited by Peter G. Welling and Francis L. S. Tse*
34. Clinical Drug Trials and Tribulations, *edited by Allen E. Cato*
35. Transdermal Drug Delivery: Developmental Issues and Research Initiatives, *edited by Jonathan Hadgraft and Richard H. Guy*
36. Aqueous Polymeric Coatings for Pharmaceutical Dosage Forms, *edited by James W. McGinity*
37. Pharmaceutical Pelletization Technology, *edited by Isaac Ghebre-Sellassie*
38. Good Laboratory Practice Regulations, *edited by Allen F. Hirsch*
39. Nasal Systemic Drug Delivery, *Yie W. Chien, Kenneth S. E. Su, and Shyi-Feu Chang*
40. Modern Pharmaceutics: Second Edition, Revised and Expanded, *edited by Gilbert S. Banker and Christopher T. Rhodes*
41. Specialized Drug Delivery Systems: Manufacturing and Production Technology, *edited by Praveen Tyle*
42. Topical Drug Delivery Formulations, *edited by David W. Osborne and Anton H. Amann*
43. Drug Stability: Principles and Practices, *Jens T. Carstensen*
44. Pharmaceutical Statistics: Practical and Clinical Applications, Second Edition, Revised and Expanded, *Sanford Bolton*
45. Biodegradable Polymers as Drug Delivery Systems, *edited by Mark Chasin and Robert Langer*
46. Preclinical Drug Disposition: A Laboratory Handbook, *Francis L. S. Tse and James J. Jaffe*

47. HPLC in the Pharmaceutical Industry, *edited by Godwin W. Fong and Stanley K. Lam*
48. Pharmaceutical Bioequivalence, *edited by Peter G. Welling, Francis L. S. Tse, and Shrikant V. Dinghe*
49. Pharmaceutical Dissolution Testing, *Umesh V. Banakar*
50. Novel Drug Delivery Systems: Second Edition, Revised and Expanded, *Yie W. Chien*
51. Managing the Clinical Drug Development Process, *David M. Cocchetto and Ronald V. Nardi*
52. Good Manufacturing Practices for Pharmaceuticals: A Plan for Total Quality Control, Third Edition, *edited by Sidney H. Willig and James R. Stoker*
53. Prodrugs: Topical and Ocular Drug Delivery, *edited by Kenneth B. Sloan*
54. Pharmaceutical Inhalation Aerosol Technology, *edited by Anthony J. Hickey*
55. Radiopharmaceuticals: Chemistry and Pharmacology, *edited by Adrian D. Nunn*
56. New Drug Approval Process: Second Edition, Revised and Expanded, *edited by Richard A. Guarino*
57. Pharmaceutical Process Validation: Second Edition, Revised and Expanded, *edited by Ira R. Berry and Robert A. Nash*
58. Ophthalmic Drug Delivery Systems, *edited by Ashim K. Mitra*
59. Pharmaceutical Skin Penetration Enhancement, *edited by Kenneth A. Walters and Jonathan Hadgraft*
60. Colonic Drug Absorption and Metabolism, *edited by Peter R. Bieck*
61. Pharmaceutical Particulate Carriers: Therapeutic Applications, *edited by Alain Rolland*
62. Drug Permeation Enhancement: Theory and Applications, *edited by Dean S. Hsieh*
63. Glycopeptide Antibiotics, *edited by Ramakrishnan Nagarajan*
64. Achieving Sterility in Medical and Pharmaceutical Products, *Nigel A. Halls*
65. Multiparticulate Oral Drug Delivery, *edited by Isaac Ghebre-Sellassie*
66. Colloidal Drug Delivery Systems, *edited by Jörg Kreuter*
67. Pharmacokinetics: Regulatory • Industrial • Academic Perspectives, Second Edition, *edited by Peter G. Welling and Francis L. S. Tse*
68. Drug Stability: Principles and Practices, Second Edition, Revised and Expanded, *Jens T. Carstensen*
69. Good Laboratory Practice Regulations: Second Edition, Revised and Expanded, *edited by Sandy Weinberg*
70. Physical Characterization of Pharmaceutical Solids, *edited by Harry G. Brittain*

71. Pharmaceutical Powder Compaction Technology, *edited by Göran Alderborn and Christer Nyström*
72. Modern Pharmaceutics: Third Edition, Revised and Expanded, *edited by Gilbert S. Banker and Christopher T. Rhodes*
73. Microencapsulation: Methods and Industrial Applications, *edited by Simon Benita*
74. Oral Mucosal Drug Delivery, *edited by Michael J. Rathbone*
75. Clinical Research in Pharmaceutical Development, *edited by Barry Bleidt and Michael Montagne*
76. The Drug Development Process: Increasing Efficiency and Cost Effectiveness, *edited by Peter G. Welling, Louis Lasagna, and Umesh V. Banakar*
77. Microparticulate Systems for the Delivery of Proteins and Vaccines, *edited by Smadar Cohen and Howard Bernstein*
78. Good Manufacturing Practices for Pharmaceuticals: A Plan for Total Quality Control, Fourth Edition, Revised and Expanded, *Sidney H. Willig and James R. Stoker*
79. Aqueous Polymeric Coatings for Pharmaceutical Dosage Forms: Second Edition, Revised and Expanded, *edited by James W. McGinity*
80. Pharmaceutical Statistics: Practical and Clinical Applications, Third Edition, *Sanford Bolton*
81. Handbook of Pharmaceutical Granulation Technology, *edited by Dilip M. Parikh*
82. Biotechnology of Antibiotics: Second Edition, Revised and Expanded, *edited by William R. Strohl*
83. Mechanisms of Transdermal Drug Delivery, *edited by Russell O. Potts and Richard H. Guy*
84. Pharmaceutical Enzymes, *edited by Albert Lauwers and Simon Scharpé*
85. Development of Biopharmaceutical Parenteral Dosage Forms, *edited by John A. Bontempo*
86. Pharmaceutical Project Management, *edited by Tony Kennedy*
87. Drug Products for Clinical Trials: An International Guide to Formulation • Production • Quality Control, *edited by Donald C. Monkhouse and Christopher T. Rhodes*
88. Development and Formulation of Veterinary Dosage Forms: Second Edition, Revised and Expanded, *edited by Gregory E. Hardee and J. Desmond Baggot*
89. Receptor-Based Drug Design, *edited by Paul Leff*
90. Automation and Validation of Information in Pharmaceutical Processing, *edited by Joseph F. deSpautz*
91. Dermal Absorption and Toxicity Assessment, *edited by Michael S. Roberts and Kenneth A. Walters*

92. *Pharmaceutical Experimental Design*, Gareth A. Lewis, Didier Mathieu, and Roger Phan-Tan-Luu
93. *Preparing for FDA Pre-Approval Inspections*, edited by Martin D. Hynes III
94. *Pharmaceutical Excipients: Characterization by IR, Raman, and NMR Spectroscopy*, David E. Bugay and W. Paul Findlay
95. *Polymorphism in Pharmaceutical Solids*, edited by Harry G. Brittain
96. *Freeze-Drying/Lyophilization of Pharmaceutical and Biological Products*, edited by Louis Rey and Joan C. May
97. *Percutaneous Absorption: Drugs–Cosmetics–Mechanisms–Methodology*, Third Edition, Revised and Expanded, edited by Robert L. Bronaugh and Howard I. Maibach
98. *Bioadhesive Drug Delivery Systems: Fundamentals, Novel Approaches, and Development*, edited by Edith Mathiowitz, Donald E. Chickering III, and Claus-Michael Lehr
99. *Protein Formulation and Delivery*, edited by Eugene J. McNally
100. *New Drug Approval Process: Third Edition, The Global Challenge*, edited by Richard A. Guarino
101. *Peptide and Protein Drug Analysis*, edited by Ronald E. Reid
102. *Transport Processes in Pharmaceutical Systems*, edited by Gordon L. Amidon, Ping I. Lee, and Elizabeth M. Topp
103. *Excipient Toxicity and Safety*, edited by Myra L. Weiner and Lois A. Kotkoskie
104. *The Clinical Audit in Pharmaceutical Development*, edited by Michael R. Hamrell
105. *Pharmaceutical Emulsions and Suspensions*, edited by Françoise Nielloud and Gilberte Marti-Mestres
106. *Oral Drug Absorption: Prediction and Assessment*, edited by Jennifer B. Dressman and Hans Lennernäs
107. *Drug Stability: Principles and Practices*, Third Edition, Revised and Expanded, edited by Jens T. Carstensen and C. T. Rhodes
108. *Containment in the Pharmaceutical Industry*, edited by James P. Wood
109. *Good Manufacturing Practices for Pharmaceuticals: A Plan for Total Quality Control from Manufacturer to Consumer*, Fifth Edition, Revised and Expanded, Sidney H. Willig
110. *Advanced Pharmaceutical Solids*, Jens T. Carstensen
111. *Endotoxins: Pyrogens, LAL Testing, and Depyrogeneration*, Second Edition, Revised and Expanded, Kevin L. Williams
112. *Pharmaceutical Process Engineering*, Anthony J. Hickey and David Ganderton
113. *Pharmacogenomics*, edited by Werner Kalow, Urs A. Meyer, and Rachel F. Tyndale
114. *Handbook of Drug Screening*, edited by Ramakrishna Seethala and Prabhavathi B. Fernandes

115. Drug Targeting Technology: Physical • Chemical • Biological Methods, *edited by Hans Schreier*
116. Drug–Drug Interactions, *edited by A. David Rodrigues*
117. Handbook of Pharmaceutical Analysis, *edited by Lena Ohannesian and Anthony J. Streeter*
118. Pharmaceutical Process Scale-Up, *edited by Michael Levin*
119. Dermatological and Transdermal Formulations, *edited by Kenneth A. Walters*
120. Clinical Drug Trials and Tribulations: Second Edition, Revised and Expanded, *edited by Allen Cato, Lynda Sutton, and Allen Cato III*
121. Modern Pharmaceutics: Fourth Edition, Revised and Expanded, *edited by Gilbert S. Banker and Christopher T. Rhodes*
122. Surfactants and Polymers in Drug Delivery, *Martin Malmsten*
123. Transdermal Drug Delivery: Second Edition, Revised and Expanded, *edited by Richard H. Guy and Jonathan Hadgraft*
124. Good Laboratory Practice Regulations: Second Edition, Revised and Expanded, *edited by Sandy Weinberg*
125. Parenteral Quality Control: Sterility, Pyrogen, Particulate, and Package Integrity Testing: Third Edition, Revised and Expanded, *Michael J. Akers, Daniel S. Larrimore, and Dana Morton Guazzo*
126. Modified-Release Drug Delivery Technology, *edited by Michael J. Rathbone, Jonathan Hadgraft, and Michael S. Roberts*
127. Simulation for Designing Clinical Trials: A Pharmacokinetic-Pharmacodynamic Modeling Perspective, *edited by Hui C. Kimko and Stephen B. Duffull*
128. Affinity Capillary Electrophoresis in Pharmaceutics and Biopharmaceutics, *edited by Reinhard H. H. Neubert and Hans-Hermann Rüttinger*
129. Pharmaceutical Process Validation: An International Third Edition, Revised and Expanded, *edited by Robert A. Nash and Alfred H. Wachter*
130. Ophthalmic Drug Delivery Systems: Second Edition, Revised and Expanded, *edited by Ashim K. Mitra*
131. Pharmaceutical Gene Delivery Systems, *edited by Alain Rolland and Sean M. Sullivan*
132. Biomarkers in Clinical Drug Development, *edited by John C. Bloom and Robert A. Dean*
133. Pharmaceutical Extrusion Technology, *edited by Isaac Ghebre-Sellassie and Charles Martin*
134. Pharmaceutical Inhalation Aerosol Technology: Second Edition, Revised and Expanded, *edited by Anthony J. Hickey*
135. Pharmaceutical Statistics: Practical and Clinical Applications, Fourth Edition, *Sanford Bolton and Charles Bon*
136. Compliance Handbook for Pharmaceutics, Medical Devices, and Biologics, *edited by Carmen Medina*



137. Freeze-Drying/Lyophilization of Pharmaceutical and Biological Products: Second Edition, Revised and Expanded, *edited by Louis Rey and Joan C. May*
138. Supercritical Fluid Technology for Drug Product Development, *edited by Peter York, Uday B. Kompella, and Boris Y. Shekunov*
139. New Drug Approval Process: Fourth Edition, Accelerating Global Registrations, *edited by Richard A. Guarino*
140. Microbial Contamination Control in Parenteral Manufacturing, *edited by Kevin L. Williams*
141. New Drug Development: Regulatory Paradigms for Clinical Pharmacology and Biopharmaceutics, *edited by Chandrahas G. Sahajwalla*
142. Microbial Contamination Control in the Pharmaceutical Industry, *edited by Luis Jimenez*
143. Generic Drug Product Development: Solid Oral Dosage Forms, *edited by Leon Shargel and Izzy Kanfer*
144. Introduction to the Pharmaceutical Regulatory Process, *edited by Ira R. Berry*
145. Drug Delivery to the Oral Cavity: Molecules to Market, *edited by Tapash K. Ghosh and William R. Pfister*
146. Good Design Practices for GMP Pharmaceutical Facilities, *edited by Andrew Signore and Terry Jacobs*
147. Drug Products for Clinical Trials, Second Edition, *edited by Donald Monkhouse, Charles Carney, and Jim Clark*
148. Polymeric Drug Delivery Systems, *edited by Glen S. Kwon*
149. Injectable Dispersed Systems: Formulation, Processing, and Performance, *edited by Diane J. Burgess*
150. Laboratory Auditing for Quality and Regulatory Compliance, *Donald Singer, Raluca-Ioana Stefan, and Jacobus van Staden*
151. Active Pharmaceutical Ingredients: Development, Manufacturing, and Regulation, *edited by Stanley H. Nusim*
152. Preclinical Drug Development, *edited by Mark C. Rogge and David Taft*
153. Pharmaceutical Stress Testing: Predicting Drug Degradation, *edited by Steven W. Baertschi*
154. Handbook of Pharmaceutical Granulation Technology: Second Edition, *edited by Dilip M. Parikh*

# Handbook of Pharmaceutical Granulation Technology

**Second Edition**

edited by

**Dilip M. Parikh**

*Synthon Pharmaceuticals Inc.*

*Research Triangle Park, North Carolina, U.S.A.*



**Taylor & Francis**  
Taylor & Francis Group

Boca Raton London New York Singapore

Published in 2005 by  
Taylor & Francis Group  
6000 Broken Sound Parkway NW, Suite 300  
Boca Raton, FL 33487-2742

© 2005 by Taylor & Francis Group, LLC

No claim to original U.S. Government works  
Printed in the United States of America on acid-free paper  
10 9 8 7 6 5 4 3 2 1

International Standard Book Number-10: 0-8247-2647-2 (Hardcover)  
International Standard Book Number-13: 978-0-8247-2647-8 (Hardcover)

This book contains information obtained from authentic and highly regarded sources. Reprinted material is quoted with permission, and sources are indicated. A wide variety of references are listed. Reasonable efforts have been made to publish reliable data and information, but the author and the publisher cannot assume responsibility for the validity of all materials or for the consequences of their use.

No part of this book may be reprinted, reproduced, transmitted, or utilized in any form by any electronic, mechanical, or other means, now known or hereafter invented, including photocopying, microfilming, and recording, or in any information storage or retrieval system, without written permission from the publishers.

For permission to photocopy or use material electronically from this work, please access [www.copyright.com](http://www.copyright.com) (<http://www.copyright.com>) or contact the Copyright Clearance Center, Inc. (CCC) 222 Rosewood Drive, Danvers, MA 01923, 978-750-8400. CCC is a not-for-profit organization that provides licenses and registration for a variety of users. For organizations that have been granted a photocopy license by the CCC, a separate system of payment has been arranged.

**Trademark Notice:** Product or corporate names may be trademarks or registered trademarks, and are used only for identification and explanation without intent to infringe.

---

**Library of Congress Cataloging-in-Publication Data**

---

Catalog record is available from the Library of Congress

---

**T&F** informa

Taylor & Francis Group  
is the Academic Division of T&F Informa plc.

Visit the Taylor & Francis Web site at  
<http://www.taylorandfrancis.com>

Do not follow where the path may lead. Go instead where there is  
no path and leave a trail.

— *Ralph Waldo Emerson*

*To*

*My wife, Leena Parikh, M.D. and  
my son, Neehar Parikh, M.D.  
for your support during this project  
and*

*All of the co-workers at various companies and  
friends from whom I have learned  
over the last thirty years.*

*Thank you.*

# Preface

It has been over eight years since the first edition of the *Handbook of Pharmaceutical Granulation Technology* was published. The enthusiastic reception afforded by the scientific community was heartwarming.

The basic science of granulation has not changed much over the last few years; however, a better understanding of the theory of granulation and the proliferation of different dosage forms has. The second edition seeks to improve and update the content of the first edition, as well as to enlarge the coverage by addition of new chapters that reflect the current state of the technology and the regulatory environment.

The pharmaceutical industry has seen several waves of consolidation with each successive year. The economic pressures on the industry have been increasing due to political policies and dwindling supply of new chemical entities. The surge in expiration of patents has given opportunities to the generic drug industry as never seen before and the trend will continue for some time to come. The emergence of biotechnology as the new resource for new drug candidates is exciting. To maintain market share and remain in the forefront of technological advances, a number of different dosage forms utilizing different granulation technologies have been explored. The technologies of interest include techniques for producing rapid release dosage forms, the use of various meltable materials for melt pelletizations and the manufacture of controlled release dosage forms. Thus, a new chapter on the rapid release granulation techniques is included in this edition. A chapter on melt granulation and pelletization is added together with another on effervescent granulation. These additions provide pharmaceutical scientists a spectrum of granulation techniques reflecting the current state of the art. Additionally, the chapter on spray drying is revised to include the spray congealing technique, which is also becoming popular.

Regulatory requirements in the pharmaceutical industry have created the need for an understanding of this unit operation at an early stage of product formulation, method selection, and process development. Because the process and specifications for the pivotal batches and full-scale production batches “must be equivalent,” the need for reliable control of the manufacturing process used to produce the test and clinical batches cannot be overemphasized.

The FDA’s Process Analytical Technology (PAT) initiative is an effort to facilitate the introduction of new manufacturing technologies in the pharmaceutical

industry for achieving more efficient processes. PATs are systems that enhance process understanding and assist in identifying and controlling critical points in a process. These include appropriate measurement devices, which can be placed in- or on-line, statistical and information technology tools, and a scientific systems approach for data analysis to control processes that will ensure production of in-process materials and final products of the desired quality. A separate chapter on PAT covers this important topic.

Every chapter in this edition is updated to reflect new developments in the technologies and how these technologies are used to produce the desired granulation end product.

This book is designed to give readers comprehensive knowledge of the subject. As in the earlier edition, chapters include an appropriate level of theory on the fundamentals of powder characterization, granulation, and state-of-the-art technology. However, the emphasis is on the application of these basic principles to the industrial practice of producing pharmaceutical granulation for subsequent processing into dosage forms. The new regulatory requirements along with the new technologies employed in the industry and contemporary approaches to producing pharmaceutical granulation are important areas covered in this second edition.

Pharmaceutical professionals, such as research and development scientists, process engineers, validation specialists, process specialists, quality assurance and quality control professionals, and graduate students in industrial pharmacy programs will find the level of theory appropriate and the wealth of practical information from renowned pharmaceutical professionals invaluable. The knowledge provided will be invaluable for selecting the appropriate granulation technology, while keeping in mind regulatory requirements and cost effectiveness.

I would like to acknowledge the support and cooperation of all the contributing authors throughout this process; to them I offer a most sincere thank you. Without their dedication and timely submission of material, this book would not have gone to print. I would also like to give special mention to Dr. Paul Heng (National University of Singapore) and Dr. Gurvinder Singh Rekhi (Elan Drug Delivery, Inc.) for their invaluable support during this project.

A special recognition goes to Ms. Sandra Beberman, Vice President of Taylor & Francis Books. It was with her encouragement that I was driven to revise and update the second edition of this book. I am overwhelmed by the wide acceptance of the first edition throughout the worldwide pharmaceutical industry and academics. It is my hope that this second edition will continue to serve as a reference tool and will provide useful knowledge in this important unit operation.

**Dilip M. Parikh**

# Contents

*Preface* . . . . . vii  
*Contributors* . . . . . xv

<b>1. Introduction</b> . . . . .	<b>1</b>
<i>Dilip M. Parikh</i>	
References . . . . .	6
<b>2. Theory of Granulation: An Engineering Perspective</b> . . . . .	<b>7</b>
<i>Bryan J. Ennis</i>	
1. Introduction . . . . .	7
2. Wetting . . . . .	19
3. Granule Growth and Consolidation . . . . .	34
4. Granule Strength and Breakage . . . . .	55
5. Controlling Granulation Processes . . . . .	60
References . . . . .	77
<b>3. Drug Substance and Excipient Characterization</b> . . . . .	<b>79</b>
<i>L. W. Chan and P. W. S. Heng</i>	
1. Introduction . . . . .	79
2. Particle Shape, Size, and Surface Area . . . . .	80
3. Solubility . . . . .	89
4. Crystal Properties and Polymorphism . . . . .	95
5. Other Physical Properties . . . . .	100
6. Commonly Used Excipients in Granulation . . . . .	102
7. Compatibility of Drug and Excipient . . . . .	103
8. Conclusion . . . . .	105
References . . . . .	106
<b>4. Binders and Solvents</b> . . . . .	<b>109</b>
<i>Ehab Hamed, Derek Moe, Raj Khankari, and John Hontz</i>	
1. Introduction . . . . .	109
2. Types of Binders . . . . .	109
3. Factors Influencing Binder Efficiency . . . . .	115



4. Processing Parameters for Commonly Used Binders . . . . .	119
References . . . . .	125
<b>5. Spray Drying and Pharmaceutical Applications . . . . .</b>	<b>129</b>
<i>Metin Çelik and Susan C. Wendel</i>	
1. Introduction . . . . .	129
2. Spray Drying Process Stages . . . . .	130
3. Process Layouts . . . . .	138
4. Theory of Spray Drying Fundamentals . . . . .	139
5. Spray Drying Applications . . . . .	146
6. Conclusion . . . . .	154
References . . . . .	155
<b>6. Roller Compaction Technology . . . . .</b>	<b>159</b>
<i>Ronald W. Miller</i>	
1. Introduction . . . . .	159
2. Powder Granulation and Compaction . . . . .	159
3. Background . . . . .	160
4. Benefits of Roller Compaction . . . . .	161
5. Compaction Theory . . . . .	162
6. Design Features of Roller Compactors . . . . .	166
7. Roll Configuration . . . . .	167
8. Feed Screw Design . . . . .	170
9. Future Trends in Granulation Technology . . . . .	172
10. New Findings . . . . .	173
11. Deaeration Theory . . . . .	178
12. Roller Compaction and Near-Infrared Spectroscopy . . . . .	182
13. Roller Compaction and PAT . . . . .	185
References . . . . .	188
<b>7. High-Shear Granulation . . . . .</b>	<b>191</b>
<i>Rajeev Gokhale, Yichun Sun, and Atul J. Shukla</i>	
1. Introduction . . . . .	191
2. High-Shear Granulators . . . . .	192
3. High-Shear Granulation Process . . . . .	195
4. Mechanism of High Shear Wet Granulation . . . . .	200
5. Factors Affecting the Granulation Process and Granule Properties . . . . .	204
6. Granulation End-Point Determination . . . . .	212
7. Formulation Development (Optimization) . . . . .	217
8. Process Scale-Up . . . . .	219
9. Conclusion . . . . .	224
References . . . . .	224

<b>8. Low-Shear Granulation</b> .....	<b>229</b>
<i>Tom Chirkot and Cecil Propst</i>	
1. Introduction .....	229
2. Mechanical Agitator Granulators .....	231
3. Rotating Shape Granulators .....	235
4. Scale-Up .....	240
5. End-Point Determination and Control .....	243
6. Conclusions .....	244
References .....	244
<b>9. Batch Fluid Bed Granulation</b> .....	<b>247</b>
<i>Dilip M. Parikh and Martin Mogavero</i>	
1. Introduction .....	247
2. Fluidization Theory .....	248
3. System Description .....	251
4. Particle Agglomeration and Granule Growth .....	261
5. Fluid Bed Drying .....	265
6. Process and Variables in Granulation .....	268
7. Process Controls and Automation .....	276
8. Process Scale-Up .....	282
9. Safety in Fluid Bed .....	286
10. Material Handling Options .....	291
11. Fluid Bed Technology Progress .....	294
References .....	304
<b>10. Single-Pot Processing</b> .....	<b>311</b>
<i>Harald Stahl and Griet Van Vaerenbergh</i>	
1. Introduction .....	311
2. Typical Single-Pot Process .....	313
3. Drying Methods for Single-Pot Processors .....	315
4. Other Processes and Applications .....	321
5. Scale-Up of Drying Processes .....	324
6. Cleaning .....	326
7. Product Stability .....	326
8. Regulatory Considerations .....	326
9. Validation of Single-Pot Processors .....	327
10. Control Systems and Data Acquisition Systems .....	328
11. Safety .....	328
12. Conclusion .....	330
References .....	330
<b>11. Extrusion/Spheronization as a Granulation Technique</b> .....	<b>333</b>
<i>Ketan A. Mehta, Gurvinder Singh Rekhi, and Dilip M. Parikh</i>	
1. Introduction .....	333
2. Applications .....	335
3. General Process Description .....	336

4. Equipment Description and Process Parameters . . . . .	337
5. Formulation Variables . . . . .	352
6. Compression of Pellets . . . . .	357
7. Conclusions . . . . .	359
References . . . . .	360
<b>12. Effervescent Granulation . . . . .</b>	<b>365</b>
<i>Guia Bertuzzi</i>	
1. Introduction . . . . .	365
2. The Effervescent Reaction . . . . .	366
3. Formulation . . . . .	366
4. Raw Materials . . . . .	367
5. Manufacturing of Effervescent Forms . . . . .	371
References . . . . .	382
<b>13. Melt Granulation and Pelletization . . . . .</b>	<b>385</b>
<i>T. W. Wong, W. S. Cheong, and P. W. S. Heng</i>	
1. Introduction . . . . .	385
2. Mechanism of Melt Agglomeration . . . . .	389
3. Factors Affecting Melt Agglomeration . . . . .	393
4. Control of Melt Agglomeration . . . . .	395
5. Conclusions . . . . .	400
References . . . . .	401
<b>14. Rapid Release Granulation . . . . .</b>	<b>407</b>
<i>P. W. S. Heng, Anthony Yolande, and Lee Chin Chiat</i>	
1. Introduction . . . . .	407
2. Formulation-Related Factors . . . . .	409
3. Granulation-Related Factors . . . . .	417
4. Solid Dispersion . . . . .	419
5. Conclusions . . . . .	423
References . . . . .	424
<b>15. Continuous Granulation Technologies . . . . .</b>	<b>431</b>
<i>Rudolf Schroeder and Klaus-Jürgen Steffens</i>	
1. Introduction . . . . .	431
2. Comparison of Different Modes of Processing . . . . .	431
3. Fluid Bed Systems . . . . .	433
4. Mechanical Wet Granulation Systems . . . . .	437
5. Roller Extrusion System . . . . .	441
References . . . . .	456
<b>16. Scale-Up Considerations in Granulation . . . . .</b>	<b>459</b>
<i>Y. He, L. X. Liu, and J. D. Litster</i>	
1. Introduction . . . . .	459
2. General Considerations in Process Scale-Up: Dimensional Analysis and the Principle of Similarity . . . . .	460

3. Analysis of Granulation Rate Processes and Implications for Scale-Up . . . .	462
4. Scale-Down, Formulation Characterization, and Formulation Design in Pharmaceutical Granulation . . . .	473
5. Scale-Up of Fluidized Bed Granulators . . . .	475
6. Scale-Up of High-Shear Mixer Granulators . . . .	480
7. Concluding Remarks . . . .	487
Nomenclature . . . .	487
References . . . .	488
<b>17. Sizing of Granulation . . . . .</b>	<b>491</b>
<i>Gurvinder Singh Rekhi and Richard Sidwell</i>	
1. Introduction . . . .	491
2. Theory of Comminution or Size Reduction . . . .	492
3. Properties of Feed Materials Affecting the Sizing Process . . . .	493
4. Criteria for Selection of a Mill . . . .	494
5. Classification of Mills . . . .	495
6. Wet Milling . . . .	499
7. Variables Affecting the Sizing Process . . . .	502
8. Scale-Up . . . .	507
9. Case Studies . . . .	509
10. List of Equipment Suppliers . . . .	510
References . . . .	511
<b>18. Granulation Characterization . . . . .</b>	<b>513</b>
<i>Raj Birudaraj, Sanjay Goskonda, and Poonam G. Pande</i>	
1. Introduction . . . .	513
2. Physical and Chemical Characterization of Granules . . . .	513
3. Conclusion . . . .	531
References . . . .	531
<b>19. Bioavailability and Granule Properties . . . . .</b>	<b>535</b>
<i>Sunil S. Jambhekar</i>	
1. Introduction . . . .	535
2. Bioavailability Parameters . . . .	536
3. Conclusion . . . .	541
References . . . .	542
Recommended Reading . . . .	543
<b>20. Process Analytical Technology . . . . .</b>	<b>545</b>
<i>D. Christopher Watts and Ajaz S. Hussain</i>	
1. Introduction . . . .	545
2. Background . . . .	546
3. PAT and Process Understanding . . . .	548

4. PAT Tools and Their Application . . . . .	549
5. Conclusion . . . . .	552
References . . . . .	552
<b>21. Granulation Process Modeling . . . . .</b>	<b>555</b>
<i>I. T. Cameron and F. Y. Wang</i>	
1. Modeling of Granulation Systems . . . . .	555
2. Key Factors in Granulation Modeling . . . . .	560
3. Representing Granulation Processes Through Population Balances . . . . .	562
4. Solving and Using Population Balances . . . . .	570
5. Application of Modeling Techniques . . . . .	577
6. Conclusion . . . . .	590
References . . . . .	591
<b>22. Regulatory Issues in Granulation . . . . .</b>	<b>595</b>
<i>Prasad Kanneganti</i>	
1. Introduction . . . . .	595
2. Pharmaceutical Quality Management . . . . .	595
3. Postapproval Change Considerations . . . . .	597
4. Validation of Granulation Processes . . . . .	609
5. Conclusion . . . . .	613
References . . . . .	613

# Contributors

**Guia Bertuzzi** IMA S.p.A., Solid Dose Division, Bologna, Italy

**Raj Birudaraj** Roche Palo Alto, Palo Alto, California, U.S.A.

**I. T. Cameron** Particle and Systems Design Centre, School of Engineering,  
The University of Queensland, Queensland, Australia

**L. W. Chan** National University of Singapore, Singapore

**W. S. Cheong** National University of Singapore, Singapore

**Lee Chin Chiat** International Specialty Products (ISP) Asia Pacific Pte. Ltd.,  
Singapore

**Tom Chirkot** Patterson-Kelly Co., East Stroudsburg, Pennsylvania, U.S.A.

**Metin Çelik** Pharmaceutical Technologies International, Inc., Belle Mead,  
New Jersey, U.S.A.

**Bryan J. Ennis** E&G Associates, Inc., Nashville, Tennessee, U.S.A.

**Rajeev Gokhale\*** Incyte Corporation, Wilmington, Delaware, U.S.A.

**Sanjay Goskonda** Durect Corp., Cupertino, California, U.S.A.

**Ehab Hamed** CIMA Labs Inc., Eden Prairie, Minnesota, U.S.A.

**Y. He** Particle and Systems Design Centre, Division of Chemical Engineering,  
School of Engineering, The University of Queensland, Queensland, Australia

**P. W. S. Heng** National University of Singapore, Singapore

**John Hontz** Biovail, Chantilly, Virginia, U.S.A.

---

\**Present Address:* Merck Research Laboratories, West Point, Pennsylvania, U.S.A.

**Ajaz S. Hussain** Office of Pharmaceutical Science, Center for Drug Evaluation and Research, Food and Drug Administration, Bethesda, Maryland, U.S.A.

**Sunil S. Jambhekar** South University School of Pharmacy, Savannah, Georgia, U.S.A.

**Prasad Kanneganti** Quality Operations, Pfizer Global Manufacturing, Pfizer Asia Pacific Pte. Ltd., Singapore

**Raj Khankari** CIMA Labs Inc., Eden Prairie, Minnesota, U.S.A.

**J. D. Litster** Particle and Systems Design Centre, Division of Chemical Engineering, School of Engineering, The University of Queensland, Queensland, Australia

**L. X. Liu** Particle and Systems Design Centre, Division of Chemical Engineering, School of Engineering, The University of Queensland, Queensland, Australia

**Ketan A. Mehta** RÖHM Pharma, Degussa Corp., Piscataway, New Jersey, U.S.A.

**Ronald W. Miller** Bristol-Myers Squibb Company, New Brunswick, New Jersey, U.S.A.

**Derek Moe** CIMA Labs Inc., Eden Prairie, Minnesota, U.S.A.

**Martin Mogavero** Niro Pharma Systems, Columbia, Maryland, U.S.A.

**Poonam G. Pande** Synthon Pharmaceuticals Inc., Research Triangle Park, North Carolina, U.S.A.

**Dilip M. Parikh** Synthon Pharmaceuticals Inc., Research Triangle Park, North Carolina, U.S.A.

**Cecil Propst** SPI Pharma, Norton Shores, Michigan, U.S.A.

**Gurvinder Singh Rekhi** Elan Drug Delivery Inc., Gainesville, Georgia, U.S.A.

**Rudolf Schroeder\*** L.B. Bohle Maschinen und Verfahren GmbH, Ennigerloh, Germany

**Atul J. Shukla** College of Pharmacy, University of Tennessee, Memphis, Tennessee, U.S.A.

**Richard Sidwell** Elan Drug Delivery Inc., Gainesville, Georgia, U.S.A.

**Harald Stahl** Niro Pharma Systems, Muellheim, Germany

---

\*Present Address: Abbott GmbH & Co. KG, Ludwigshafen, Germany.

**Klaus-Jürgen Steffens** Department of Pharmaceutical Technology,  
University of Bonn, Bonn, Germany

**Yichun Sun** College of Pharmacy, University of Tennessee, Memphis,  
Tennessee, U.S.A.

**Griet Van Vaerenbergh** Collette N.V., Wommelgren, Belgium

**F. Y. Wang** Particle and Systems Design Centre, School of Engineering,  
The University of Queensland, Queensland, Australia

**D. Christopher Watts** Office of Pharmaceutical Science, Center for Drug  
Evaluation and Research, Food and Drug Administration, Bethesda, Maryland,  
U.S.A.

**Susan C. Wendel** Elan NanoSystems, King of Prussia, Pennsylvania, U.S.A.

**T. W. Wong** Faculty of Pharmacy, University of Technology MARA, Selangor,  
Malaysia

**Anthony Yolande** International Specialty Products (ISP) Asia Pacific Pte. Ltd.,  
Singapore



# 1

## Introduction

**Dilip M. Parikh**

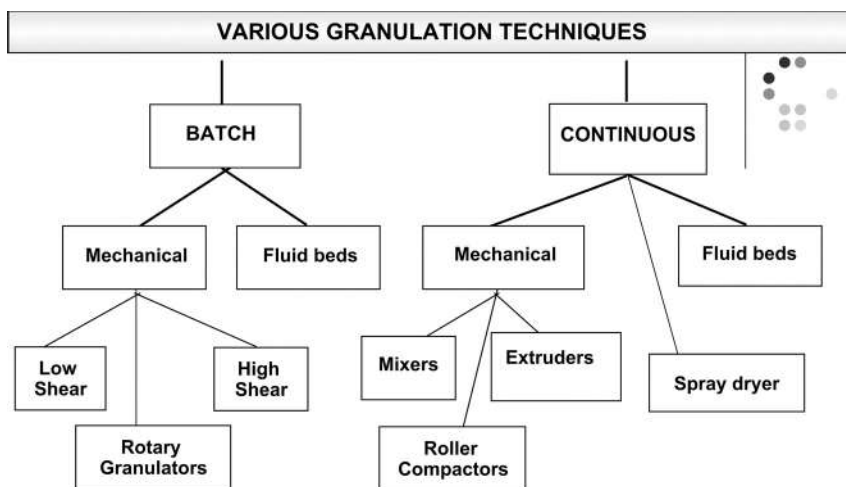
*Synthon Pharmaceuticals Inc., Research Triangle Park, North Carolina, U.S.A.*

Perry's *Chemical Engineer's Handbook* (1) defines the granulation process as "any process whereby small particles are gathered into larger, permanent masses in which the original particles can still be identified." This definition is of course particularly appropriate to a pharmaceutical granulation where the rapid breakdown of agglomerates is important to maximize the available surface area and aid in solution of the active drug. The granulation process of size enlargement used within the pharmaceutical industry has its roots in ancient times. The practice of delivering medicinal powder by hand rolling into a pill by using honey or sugar has been used for centuries. It is still the practice to deliver the botanical and herbal extract in homeopathic and ayurvedic branches of medicine, which are still practiced in India along with allopathic medicine. The term "granulated" material is derived from the Latin word "granulatum," meaning grained. The granulated material can be obtained by direct size enlargement of primary particles, or size reduction from dry compacted material. In modern times, granulation technology has been widely used by a wide range of industries, such as coal, mining, and agrochemical. These industries employ agglomeration techniques to reduce dust, provide ease of handling, and enhance the material's ultimate utility.

The development of pharmaceutical granulation was driven by the invention of the tablet press by W. Brockedon in 1843. Subsequent improvements in the tablet machinery were patented in the United States by J. A. McFerran (1874), T. J. Young (1874), and J. Dunton (1876). The demands on the granulation properties were further enhanced in the 1970s as high-speed tablet and capsule filling machines with automated controls were introduced. The continuous refinements in the regulatory requirements such as low-dose products requiring blend uniformity/content uniformity necessitated knowledge and technology to produce the required granule characteristics. The high-speed compression and capsule filling machines require a uniform flow of material to the dies or filling stations that produce pharmaceutical dosage form.

Granulation is an example of particle design. The desired attributes of the granule are controlled by a combination of the formulation and the process.

Granulation methods can be divided into two major types: wet methods which utilize some form of liquid to bind the primary particles, and dry methods which do not utilize any liquid (Fig. 1).



**Figure 1** Various granulation techniques.

Application of spray dryer to produce granulated product suitable for direct compression is now possible.

A new approach in the 1990s was to use supercritical fluid technology to produce uniform particles to replace crystallization. Even though super critical fluids were discovered over 100 years ago, and the commercial plant was built over 20 years ago in the United States, it is only now that the technology is used for a number of pharmaceutical applications (2–5), so as to produce aspirin, caffeine, ibuprofen, acetaminophen, etc. One of the major areas on which the research and development of supercritical fluids is focused is particle design. There are different concepts such as “rapid expansion of supercritical solution,” “gas antisolvent recrystallization,” and “supercritical antisolvent” to generate particles, microspheres, microcapsules, liposomes, or other dispersed materials.

When the supercritical fluid and drug solution make contact, a volume expansion occurs leading to a reduction in solvent capacity, increase in solute saturation, and then supersaturation with associated nucleation and particle formation. A number of advantages are claimed by using this platform technology (6), such as particle formation from nanometers to tens of micrometers, low residual solvent levels in products, preparation of polymorphic forms of drug, etc.

The classical granulation process using either wet or dry methods is employed in the process industries. Pharmaceutical granulation process is used for tablet and sometimes capsule dosage forms; however, in some applications the process is used to produce spherical granules for the modified release indications or to prepare granules as sprinkles to be used by pediatric patients. In some countries like Japan, having granulated product in a “sachet” is acceptable where a large dose of the drug product is not suitable for swallowing. The reasons for granulating a pharmaceutical compound are listed as follows:

1. To increase the uniformity of drug distribution in the product
2. To densify the material
3. To enhance the flow rates and rate uniformity
4. To facilitate metering or volumetric dispensing

5. To reduce dust
6. To improve the appearance of the product.

Five primary methods exist to form an agglomerated granule. They are formation of solid bridges, sintering, chemical reaction, crystallization, or deposition of colloidal particles. Binding can also be achieved through adhesion and cohesion forces in highly viscous binders.

Successful processing for the agglomeration of primary particles depends on proper control of the adhesional forces between particles, which encourage agglomerate formation and growth and provide adequate mechanical strength in the product. Furthermore, the rheology of the particulate system can be critical to the rearrangement of particles necessary to permit densification of the agglomerate and the development of an agglomerate structure appropriate for the end-use requirements. If the particles are close enough then the surface forces such as van der Waals forces (short-range) and electrostatic forces can interact to bond particles. Decreasing particle size increases surface-mass ratio and favors the bonding. van der Waals forces are sevenfold stronger than electrostatic forces and increase substantially when the distance between them is reduced, which can be achieved by applying pressure as in dry granulation method.

The cohesive forces that operate during the moist agglomerates are mainly due to the liquid bridges that develop between the solid particles. Electrostatic forces keep particles in contact long enough for another mechanism to govern the agglomeration process.

The processing of drug substance with the excipients can be achieved without going through the granulation steps. By simply mixing in a blender, a directly compressible formulation can be processed and compressed in tablets or filled in the hard gelatin capsules. In the 1970s, microcrystalline cellulose as a directly compressible vehicle was introduced. The compressible formulation containing microcrystalline cellulose is suitable for a number of products. This has several obvious advantages, such as lower equipment cost, faster process time, and efficient operation involving only two process steps. Sometimes excipient costs may have to be compared against the savings in the processing steps and equipment by using alternate methods.

There are, however, a number of products that require low dose of drug substance, where the blend uniformity and the content uniformity in the drug product are critical. Traditionally, the assessment of the blend uniformity is done after the blending process is complete. This required considerable delays in obtaining results, and the sampling techniques and product discharge from the blender required consistency to obtain satisfactory results. However, with the current interest in process analytical technology (PAT) on-line measurement of ingredients is possible. The U.S. Food and Drug Administration (FDA) has recently released guidance for industry detailing the current thinking on PAT (7).

Other than content uniformity of a low-dose drug substance there are a number of reasons why direct compression may not be suitable for a wide array of products. These include the required flow properties; the amount of drug substance in a dosage form may require it to be densified to reduce the size of the drug product, obtain the required hardness, friability, disintegration/dissolution, and other attributes.

Another approach which is becoming popular is to use traditional spray-drying process to produce drum to hopper granulation by-passing the conventional granulation process. This process may be suitable for large-volume products such as over-the-counter tablets or capsules.

Dry compaction technique like roller compaction is experiencing renewed interest in the industry. There are a number of drug substances which are moisture sensitive and cannot be directly compressed. The roller compaction provides suitable alternative technology for processing these products.

Early stages of wet granulation technology development, employed low-shear mixers or the mixers/blenders normally used for dry blending such as ribbon mixers. There are a number of products currently manufactured using these low-shear granulators. The process control and efficiency has increased over the years; however, the industry has embraced high-shear granulators for wet granulation because of its efficient and reproducible process and modern process control capabilities. The high-shear mixers have also facilitated new technologies, such as one-pot processing, that use the mixer to granulate and then dry using vacuum, gas stripping/vacuum, or microwave assist in the same vessel.

Fluid-bed processors have been used in the pharmaceutical industry for the last 35 years, initially only as a dryer, and now as a multiprocessor to granulate, dry, pelletize, and coat particles. The most preferred method of granulation is to use the high-shear mixer to granulate and use the fluid bed as a dryer in an integrated equipment setup. This provides the best of both technologies: efficient controllable dense wet granules and a fast drying cycle using fluid-bed dryer. Here again, the choice of this approach will be dependent on the product being processed, and its desired properties at the end of the granulation process. Extrusion/spheronization is used to produce granulation for the tableting or pelletizing, which involves mixing, extruding, spheronizing, and drying unit operations. These pellets can be produced as matrix pellets with the appropriate polymer or are coated in fluid-bed unit to produce modified release dosage forms. Table 1 illustrates various options to granulate a pharmaceutical compound.

Many researchers studied the influence of material properties of the granulating powder and process conditions on the granulation process in a rather empirical way. In the 1990s a fundamental approach to research was started on various topics in the granulation research, looking into more detailed aspects of particle wetting,

**Table 1** Frequently Used Granulation Techniques and Subsequent Processing

	Process	Drying technique
Wet granulation	Low-shear mixer	Tray or fluid-bed dryer
	High-shear mixer	Tray or fluid-bed dryer
	High-shear mixer	Vacuum/gas stripping/microwave assist—one-pot
	Fluid-bed granulator/dryer	Fluid-bed granulator/dryer
	Spray dryer	Spray dryer
	Extrusion/spheronization	Tray or fluid-bed dryer
	Continuous mixer granulator (mechanical)	Fluid bed—continuous or batch
Dry granulation	Continuous fluid-bed granulator	Fluid bed (continuous)
	Process	Further processing
	Direct compression	Blend and process further
	Slugging	Mill slugged tablets/blend/recompress/process further
	Roller compactor	Compacts milled/blend/process further

mechanism of granulation, material properties, and influence of mixing apparatus on the product. The overall hypothesis suggested that the granulation can be predicted from the raw material properties and the processing conditions of the granulation process. One of the major difficulties encountered in granulation technology is the incomplete description of the behavior of powders in general. The ongoing fundamental research on mixing, segregation mechanisms of powder, surface chemistry, and material science are necessary to develop the theoretical framework of granulation technology. An excellent review of the wet granulation process was presented by Iveson and coauthors (8). The authors have advanced the understanding of the granulation process by stating that there are three fundamental sets of rate processes which are important in determining wet granulation behavior. These are wetting and nucleation, consolidation and growth; and breakage and attrition. Once these processes are sufficiently understood, then it will be possible to predict the effect of formulation properties, equipment type, and operating conditions of granulation behavior, provided these can be adequately characterized according to the reviewers.

Efficient and cost-effective manufacturing of pharmaceutical products is being evaluated by the scientists, engineers, and operational managers of pharmaceutical companies worldwide. In the United States, where 49% of the world pharmaceutical market is, pharmaceutical companies are under tremendous pressure from the managed care organizations, politicians, and consumers. The pharmaceutical industry, worldwide in general and in the United States in particular, faces a unique paradox—drive future innovation through substantial R&D investments and return competitive margin to shareholders, while providing access to pharmaceutical products at low or no cost. The industry has reached a critical juncture in its 100-year history. The industry is impacted simultaneously by growing competition, declining market performance, increasing regulation, escalating pricing pressures, and rapidly evolving innovations for improving people's health and quality of life. A new report (9) into pharmaceutical R&D has identified an emerging trend favoring outsourcing of discovery, research, clinical trials, and manufacturing of dosage forms, providing relief from the consistent, high-growth financial return faced by the majority of pharmaceutical companies. Outsourcing allows these companies to pursue potential new revenue streams outside of their core focus areas, and to benefit from improved productivity, emerging technologies, inlicensing opportunities, and increased growth. Consumers and local governments in the United States are pressuring the FDA authorities and politicians to allow importation of the drugs from other countries like Mexico and Canada where costs are generally lower than in the United States. Demands for price control also extend to Europe; government-backed pharmaceutical payment plans in Germany and Italy, for example, have cut back reimbursements. Other European countries have controls on the drug prices. As a result of these pricing pressures and to enhance the drugs in the pipeline, mergers and acquisitions have accelerated. Acquisitions remain the preferred route to quickly enhance a product portfolio. This trend of merging of equals or takeover of the significant technological companies will continue. This has created emergence of small niche technology companies as well. Major pharmaceutical companies are witnessing the end of traditional research and development. Drug delivery companies are becoming potential targets for mergers or strategic alliances. During all of the upheaval that the industry is going through, it is becoming obvious that the cost of development and production, and cost of goods, must be controlled. Recently released draft guidance by the U.S. FDA for quality systems approach for the current good manufacturing practices may help to streamline the

compliance programs in the industry (10). The efficiencies in the research, development, and manufacturing, which were not necessarily sought after, are becoming the first priority of the pharmaceutical companies however small they may be in comparison to the final cost of the product to consumer. The manufacturing of solid dosage product is no exception.

The significant advances that have taken place in the pharmaceutical granulation technology are presented in this book to provide the readers with choices that are available. There is no substitute for good science. The characterization of the drug substance along with the knowledge of granulation theory, process modeling capability, in-line or on-line (PAT) tools, process scale-up approaches, and a good definition of the end product required will prepare the reader to explore the various options presented in this book. Each drug substance poses a unique challenge that must be taken into consideration at the process selection stage by the scientists. The various techniques presented in this book will further help the scientists in their understanding and selection of the granulation process most appropriate for the drug substance. For production engineering, validation, and quality professionals in the industry, this book is intended to provide the fundamental understanding of the technique of granulation, and the rationale behind the selection of each particular technique. This will further enhance the ability to design the production plant, carry out the technology transfer, scale-up, troubleshoot, and maintain the pharmaceutical granulation operation, in accordance with regulatory compliance.

## REFERENCES

1. Ennis BJ, Litster JD. Particle enlargement. Perry RH, Greens D, eds. *Perry's Chemical Engineer's Handbook*. 7th ed. New York: McGraw Hill, 1997:20-56-20-89.
2. Charoenchaitrakool M, Dehghani F, Foster NR. Micronization by RESS to enhance the dissolution rates of poorly water soluble pharmaceuticals. *Proceedings of the 5th International Symposium on Supercritical Fluids*, Atlanta, GA, April 8-12, 2000.
3. Matson DW, Fulton JL, Petersen RC, Smith RD. Rapid expansion of supercritical fluid solutions: solute formation of powders, thin films, and fibers. *Ind Eng Chem Res* 1987; 26:2298-2306.
4. Subra P, Boissinot P, Benzaghoul S. Precipitation of pure and mixed caffeine and anthracene by rapid expansion of supercritical solutions. *Proceedings of the 5th Meeting on Supercritical Fluids*, Tome I, Nice, France, March 23-25, 1998.
5. Gilbert DJ, Palakodaty S, Sloan R, York V. Particle engineering for pharmaceutical applications—a process scale up. *Proceedings of the 5th International Symposium on Supercritical Fluids*, Atlanta, GA, April 8-12, 2000.
6. York P, et al. Supercritical fluids ease drug delivery. *Manuf Chemist* 2000; 26-29.
7. Food and Drug Administration. *Guidance for Industry PAT—A Framework for Innovative Pharmaceutical Development, Manufacturing and Quality Assurance*. FDA, September 2004.
8. Iveson SM, Litster JD, Hopgood K, Ennis B. Nucleation, growth, and breakage phenomenon in agitated wet granulation process: a review. *Powder Technol* 2001; 117:3-39.
9. Cambridge Healthcare Advisors (CHA) Report. Report identifies increasing outsourcing by pharma—Inpharma.com, September 29, 2004.
10. Guidance for Industry. *Quality Systems Approach to Pharmaceutical Current Good Manufacturing Practice Regulations, Draft Guidance*, September 2004.

# 2

## Theory of Granulation: An Engineering Perspective

**Bryan J. Ennis**

*E&G Associates, Inc., Nashville, Tennessee, U.S.A.*

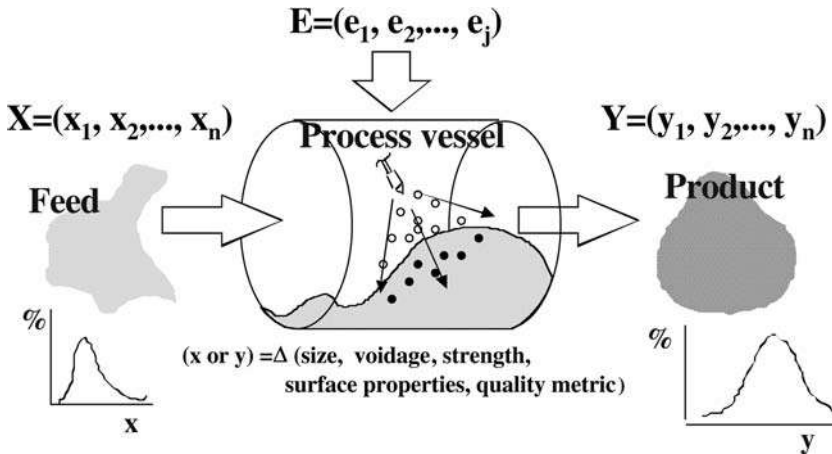
### 1. INTRODUCTION

#### 1.1. Overview

Wet granulation is a subset of size enlargement (1–5), which involves any process whereby small particles are agglomerated, compacted, or otherwise brought together into larger, relatively permanent structures in which the original particles can still be distinguished. Granulation technology and size-enlargement processes have been used by a wide range of industries, from the pharmaceutical industry to fertilizer or detergent production to the mineral processing industries. Size enlargement generally encompasses a variety of unit operations or processing techniques dedicated to particle agglomeration. These processes can be loosely broken down into agitation and compression methods.

Although terminology is industry specific, agglomeration by agitation will be referred to as *granulation*. As depicted in [Figure 1](#), a particulate feed is introduced to a process vessel and is agglomerated, either batchwise or continuously, to form a granulated product. Agitative processes include fluid bed, pan (or disk), drum, and mixer granulators. Such processes are also used as coating operations for controlled release, taste masking, and cases where solid cores may act as a carrier for a drug coating. The feed typically consists of a mixture of solid ingredients, referred to as a formulation, which includes an active or key ingredient, binders, diluents, flow aids, surfactants, wetting agents, lubricants, fillers, or end-use aids (e.g., sintering aids, colors or dyes, taste modifiers). A closely related process of spray drying is also included here, but is discussed more fully elsewhere [Refs. 6,7 and [Chapter 5](#)]. Product forms generally include agglomerated or layered granules, coated carrier cores, or spray dried product consisting of agglomerated solidified drops.

An alternative approach to size enlargement is agglomeration by compression, or *compaction*, where the mixture of particulate matter is fed to a compression device which promotes agglomeration due to pressure, as depicted in [Figure 2](#). Either continuous sheets of solid material or solid forms such as briquettes or tablets are produced. Compaction processes range from confined compression devices such as tableting to continuous devices such as roll presses ([Chapter 6](#)), briquetting machines,

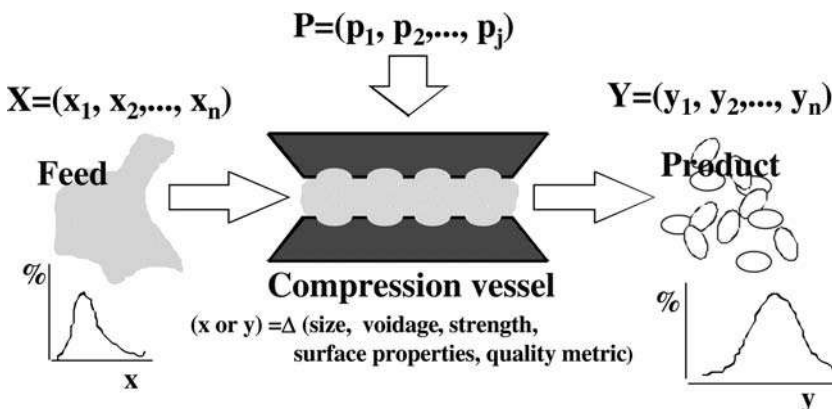


**Figure 1** The unit operation of agitative agglomeration or granulation. (From Refs. 1–5.)

and extrusion (Chapter 11). Some processes operate in a semicontinuous fashion such as ram extrusion. Capsule filling operations would be considered as low-pressure compaction processes.

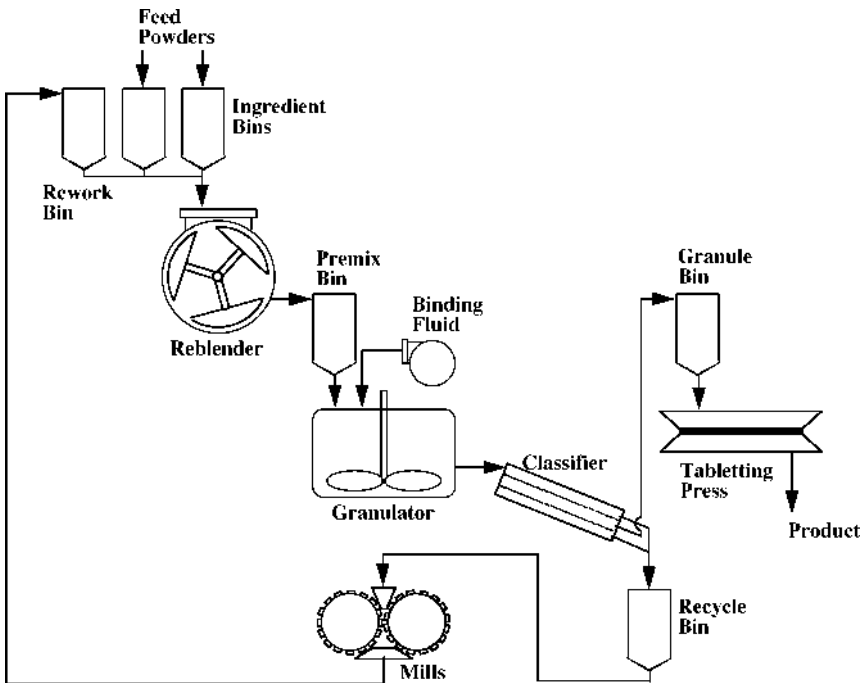
At the level of a manufacturing plant, the size-enlargement process involves several peripheral, unit operations such as milling, blending, drying, or cooling, and classification, referred to generically as an agglomeration circuit (Fig. 3). In addition, more than one agglomeration step may be present as in the case of a pharmaceutical process. In the case of pharmaceutical granulation, granulated material is almost exclusively an intermediate product form, which is then followed by tableting. In the context of granulation, therefore, it is important to understand compaction processes to establish desirable granule properties for tableting performance.

Numerous benefits result from size-enlargement processes as summarized in Table 1. A wide variety of size-enlargement methods are available; a classification of these is given in Table 2 with key process attributes. A primary purpose of wet granulation in the case of pharmaceutical processing is to create free-flowing, nonsegregating blends of ingredients of controlled strength, which may be reproducibly metered in



**Figure 2** The unit operation of compressive agglomeration or compaction. (From Refs. 1–5.)





**Figure 3** A typical agglomeration circuit utilized in the processing of pharmaceuticals involving both granulation and compression techniques. (From Refs. 1–5.)

subsequent tableting or for vial or capsule filling operations. The wet granulation process must generally achieve the desired granule properties within some prescribed range. These attributes clearly depend on the application at hand. However, common to most processes is a specific granule size distribution and granule voidage. Size distribution affects flow and segregation properties, as well as compaction behavior. Granule voidage controls strength, and impacts capsule and tablet dissolution behavior, as well as compaction behavior and tablet hardness.

Control of granule size and voidage will be discussed in detail throughout this chapter. The approach taken here relies heavily on attempting to understand interactions at a particle level, and scaling this understanding to bulk effects. Developing an understanding of these microlevel processes of agglomeration allows a rational approach to the design, scale-up, and control of agglomeration processes. Although

**Table 1** Objectives of Size Enlargement

Production of a useful structural form
Provision of a defined quantity for dispensing, with improved flow properties for metering
Improved product appearance
Reduced propensity to caking
Increased bulk density for storage
Creation of nonsegregating blends of powder ingredients
Control of solubility
Control of porosity, hardness, and surface-to-volume ratio and particle size

Source: From Refs. 1–5.

**Table 2** Size-Enlargement Methods and Application

Method	Product size (mm)	Granule density	Scale of operation	Additional comments	Typical applications
Tumbling granulators: Drums Disks	0.5–20	Moderate	0.5–800 tons/hr	Very spherical granules	Fertilizers, iron ore, nonferrous ore, agricultural chemicals
Mixer granulators					
Continuous high shear (e.g., Shugi mixer)	0.1–2	Low	Up to 50 ton/hr	Handles very cohesive materials well, both batch and continuous	Chemicals, detergents, clays, carbon black
Batch high shear (e.g., paddle mixer)	0.1–2	High	Up to 500 kg, batch		Pharmaceuticals, ceramics
Fluidized granulators: Fluidized beds Spouted beds Wurster coaters	0.1–2	Low (agglomerated), moderate (layered)	100–900 kg, batch; 50 ton/hr, continuous	Flexible, relatively easy to scale, difficult for cohesive powders, good for coating applications	Continuous: fertilizers, inorganic salts, detergents; batch: pharmaceuticals, agricultural chemicals, nuclear wastes

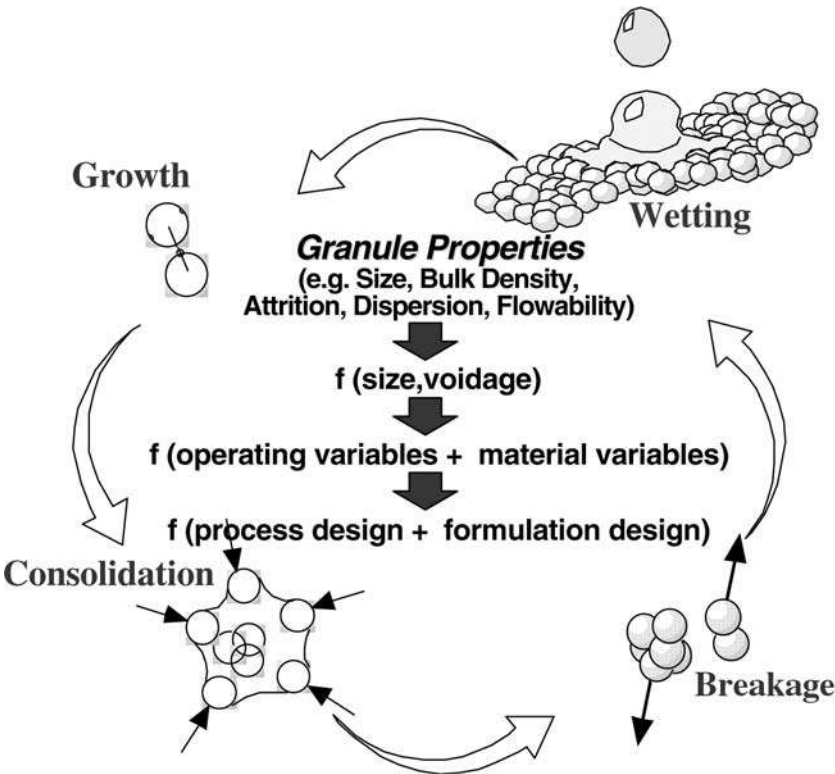
Centrifugal granulators	0.3–3	Moderate to high	Up to 200 kg, batch	Powder layering and coating applications	Pharmaceuticals, agricultural chemicals
Spray methods					
Spray drying	0.05–0.5	Low		Morphology of spray dried powders can vary widely	Instant foods, dyes, detergents, ceramics, pharmaceuticals
Prilling	0.7–2	Moderate			Urea, ammonium nitrate <sup>0</sup>
Pressure compaction					
Extrusion	>0.5	High to very high	Up to 5 ton/hr	Very narrow size distributions, very sensitive to powder flow and mechanical properties	Pharmaceuticals, catalysts, inorganic chemicals, organic chemicals, plastic preforms, metal parts, ceramics, clays, minerals, animal feeds
Roll press	>1		Up to 50 ton/hr		
Tablet press	10		Up to 1 ton/hr		
Molding press					
Pellet mill					

*Source:* From Refs. 1–5.

the approach is difficult, qualitative trends are uncovered along the way, which aid in formulation development and process optimization, and which emphasize powder characterization as an integral part of product development and process design work.

## 1.2. Granulation Mechanisms

Four key mechanisms or *rate processes* contribute to granulation, as originally outlined by Ennis (3,4), and later developed further by Ennis and Litster (1,5). These include *wetting* and nucleation, coalescence or *growth*, *consolidation*, and attrition or *breakage* (Fig. 4). Initial wetting of the feed powder and existing granules by the binding fluid is strongly influenced by spray rate or fluid distribution as well as feed formulation properties, in comparison with mechanical mixing. Wetting promotes nucleation of fine powders, or coating in the case of feed particle size in excess of drop size. Often wetting agents such as surfactants are carefully chosen to enhance poorly wetting feeds. In the coalescence or growth stage, partially wetted primary particles and larger nuclei coalesce to form granules composed of several particles. The term nucleation is typically applied to the initial coalescence of primary particles in the immediate vicinity of the larger wetting drop whereas the more general term of



**Figure 4** The rate processes of agitative agglomeration, or granulation, which include powder wetting, granule growth, granule consolidation, and granule breakage. These processes combine to control granule size and porosity, and they may be influenced by formulation or process design changes.

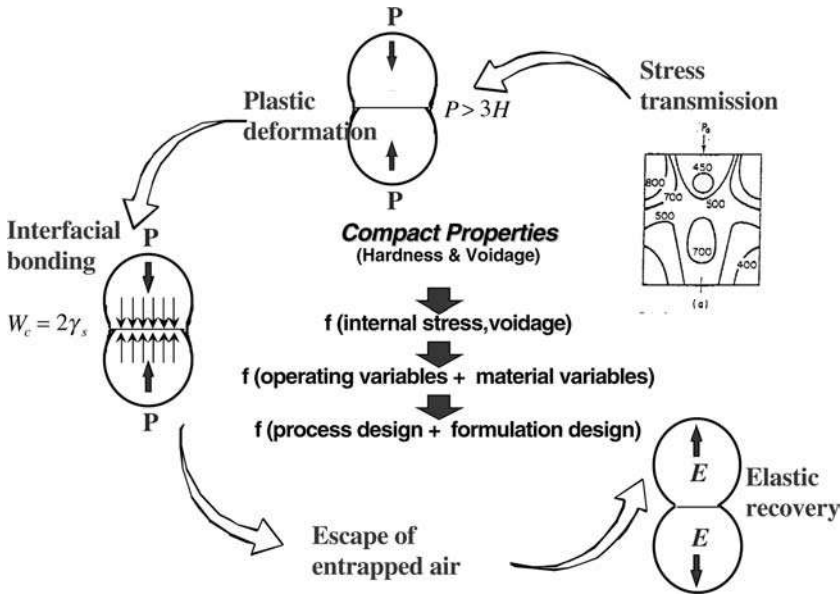
coalescence refers to the successful collision of two granules to form a new, larger granule. In addition, the term of layering is applied to the coalescence of granules with primary feed powder. Nucleation is promoted from some initial distribution of moisture, such as a drop, or from the homogenization of a fluid feed to the bed, as with high-shear mixing. The nucleation process is strongly linked with the wetting stage. As granules grow, they are consolidated by compaction forces due to bed agitation. This consolidation stage controls internal granule voidage or granule porosity, and therefore end-use properties such as granule strength, hardness, or dissolution. Formed granules may be particularly susceptible to attrition if they are inherently weak or if flaws develop during drying.

These mechanisms or *rate processes* can occur simultaneously in all granulation units, ranging from spray drying to fluidized beds to high-shear mixers. However, certain mechanisms may dominate in a particular manufacturing process. For example, fluidized bed granulators are strongly influenced by the wetting process, whereas mechanical redispersion of binding fluid by impellers and particularly high-intensity choppers diminishes the wetting contributions to granule size in high-shear mixing. On the other hand, granule consolidation is far more pronounced in high-shear mixing than in fluidized-bed granulation. These simultaneous rate processes taken as a whole—and sometimes competing against one another—determine the final granule size distribution and granule structure and voidage resulting from a process, and therefore the final end-use or product quality attributes of the granulated product.

### 1.3. Compaction Mechanisms

Compaction is a forming process controlled by mechanical properties of the feed in relationship to applied stresses and strains. Microlevel processes are controlled by particle properties such as friction, hardness, size, shape, surface energy, and elastic modulus.

Key steps in any compaction process include (1) powder filling, (2) stress application and removal, and (3) compact ejection. Powder filling and compact weight variability is strongly influenced by bulk density and powder flowability (1,2), as well as any contributing segregation tendencies of the feed. The steps of stress application and removal consist of several competing mechanisms, as depicted in [Figure 5](#). Powders do not transmit stress uniformly. Wall friction impedes the applied load, causing a drop in stress as one moves away from the point of the applied load (e.g., a punch face in tableting or roll surface in roll pressing.) Therefore, the applied load and resulting density are not uniform throughout the compact, and powder frictional properties control the stress transmission and distribution in the compact (8). The general area of study relating compaction and stress transmission is referred to as powder mechanics (1,2,8,9). For a local level of applied stress, particles deform at their point contacts, including plastic deformation for forces in excess of the particle surface hardness. This allows intimate contact at surface point contacts, allowing cohesion/adhesion to develop between particles, and therefore interfacial bonding, which is a function of their interfacial surface energy. During the short time scale of the applied load, any entrapped air must escape, which is a function of feed permeability, and a portion of the elastic strain energy is converted into permanent plastic deformation. Upon stress removal, the compact expands due to the remaining elastic recovery of the matrix, which is a function of elastic modulus, as well as any expansion of the remaining entrapped air. This can result in loss of particle bonding, and flaw development, and this is exacerbated for cases of wide distributions in



**Figure 5** The microlevel processes of compressive agglomeration, or compaction. These processes combined control compact strength, hardness, and porosity.

compact stress due to poor stress transmission. The final step of stress removal involves compact ejection, where any remaining radial elastic stresses are removed. If recovery is substantial, it can lead to capping or delamination of the compact.

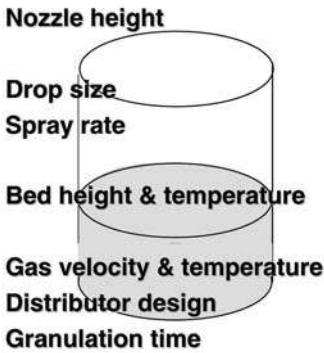
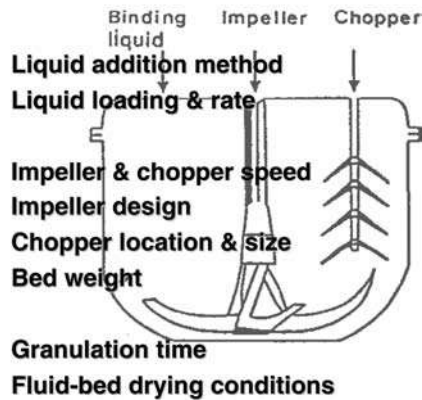
These microlevel processes of compaction control the final flow and density distribution throughout the compact, whether it is a roll pressed, extruded, or tableted product, and as such, control compact strength, hardness, and dissolution behavior. Compaction processes will not be discussed further here, with the remainder of the chapter focusing on wet granulation, agitative processes. For further discussion regarding compaction, see [Chapter 6](#) and [Refs. 1, 2, and 10](#).

#### 1.4. Formulation vs. Process Design

The end-use properties of granulated material are controlled by granule size and internal granule voidage or porosity. Internal granule voidage  $\varepsilon_{\text{granule}}$  and bed voidage  $\varepsilon_{\text{bed}}$ , or voidage between granules, are related by

$$\rho_{\text{bulk}} = \rho_{\text{granule}}(1 - \varepsilon_{\text{bed}}) = \rho_s(1 - \varepsilon_{\text{bed}})(1 - \varepsilon_{\text{granule}}) \quad (1.1)$$

where  $\rho_{\text{bulk}}$ ,  $\rho_{\text{granule}}$ , and  $\rho_s$  are bulk, granule, and skeletal primary particle density, respectively. Here, granule voidage and granule porosity will be used interchangeably. Granule structure may also influence properties. To achieve the desired product quality as defined by metrics of end-use properties, granule size and voidage may be manipulated by changes in either process operating variables or product material variables ([Figs. 4 and 5](#)) as initially outlined by Ennis (3,4), and later developed further by Ennis and Litster (1,2,5). The first approach is the realm of traditional process engineering, whereas the second is product engineering. Both approaches are critical and must be integrated to achieve the desired end point in product quality. *Operating variables* are defined by the chosen granulation technique and

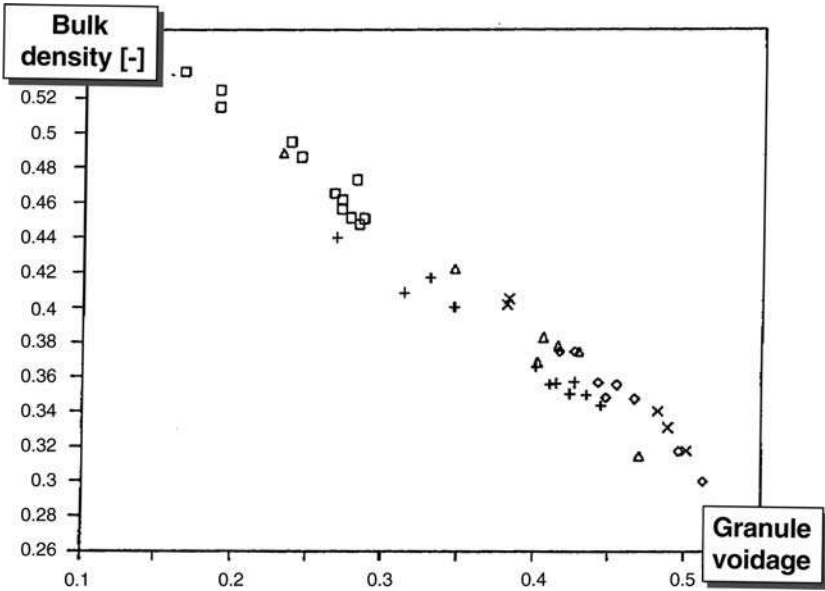
**Batch Fluid-Bed Granulator****Batch High Shear Granulator**

**Figure 6** Typical operating variable for pharmaceutical granulation processes. (From Ref. 4.)

peripheral processing equipment, as illustrated for a fluidized-bed and mixer granulator in Figure 6. In addition, the choice of agglomeration technique dictates the mixing pattern of the vessel. *Material variables* include parameters such as binder viscosity, surface tension, feed particle size distribution, powder friction, and the adhesive properties of the solidified binder. Material variables are specified by the choice of ingredients, or product formulation. Both operating and material variables together define the kinetic mechanisms and rate constants of wetting, growth, consolidation, and attrition. Overcoming a given size-enlargement problem often requires changes in both processing conditions and product formulation.

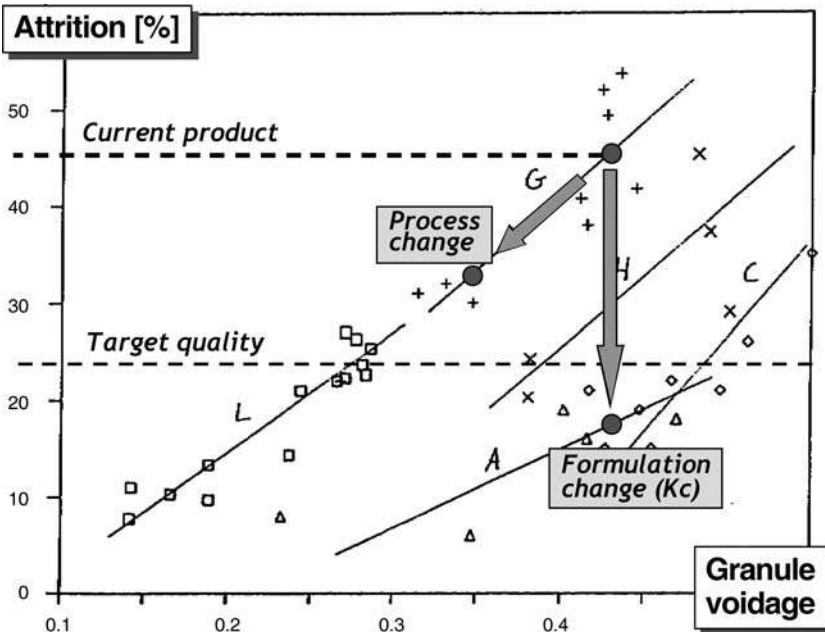
The importance of granule voidage to final product quality is illustrated in Figures 7–9 for a variety of formulations. Here, bulk density is observed to decrease, granule attrition to increase, and dissolution rate to increase with an increase in granule voidage. Bulk density is clearly a function of both granule size distribution, which controls bed voidage or porosity between granules, and the voidage within the granule itself. The data of Figure 7 are normalized with respect to its zero intercept, or its effective bulk density at zero granule voidage. The granule attrition results of Figure 8 are based on a CIPAC test method, which is effectively the percentage of fines passing a fine mesh size following attrition in a tumbling apparatus. Granules weaken with increased voidage. The dissolution results of Figure 9 measure the length required for granule dissolution in a long tube, or disintegration length (also based on the CIPAC test method). Increased granule voidage results in increased dissolution rate and shorter disintegration length. All industries have their own specific quality and in-process evaluation tests. However, what they have in common are the important contributing effects of granule size and granule voidage.

An example of the importance of distinguishing the effects of process and formulation changes can be illustrated with the help of Figures 8 and 9. Let us assume that the particular formulation and current process conditions produce a granulated material with a given attrition resistance and dissolution behavior (indicated as “current product”). If one desires instead to reach a given “target,” either the formulation or the process variable may be changed. Changes to the process, or operating variables, generally readily alter granule voidage. Examples to decrease voidage might include increased bed height, increased processing time,



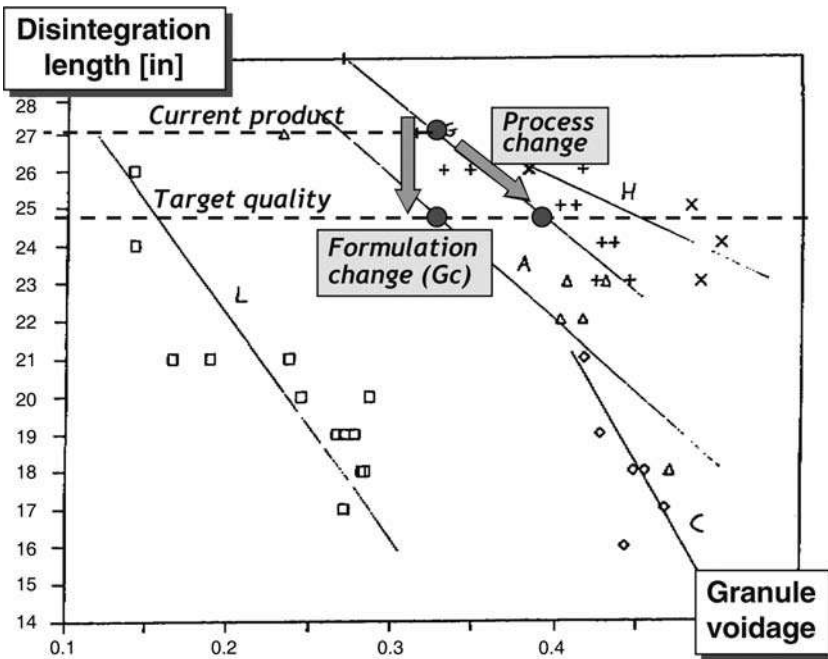
**Figure 7** Impact of granule density on bulk density: Normalized bulk density as a function of granule voidage. (From Ref. 4.)

or increased peak bed moisture. However, only a range of such changes in voidage, and therefore attrition resistance and dissolution, is possible and is illustrated by moving along the given formulation curve. The various curves in Figures 8 and 9 are due instead to changes in formulation properties. Therefore, it may not be



**Figure 8** Impact of granule density on strength and attrition: Illustration of process changes vs. formulation changes.  $K_c$  is the fracture toughness. (From Ref. 4.)





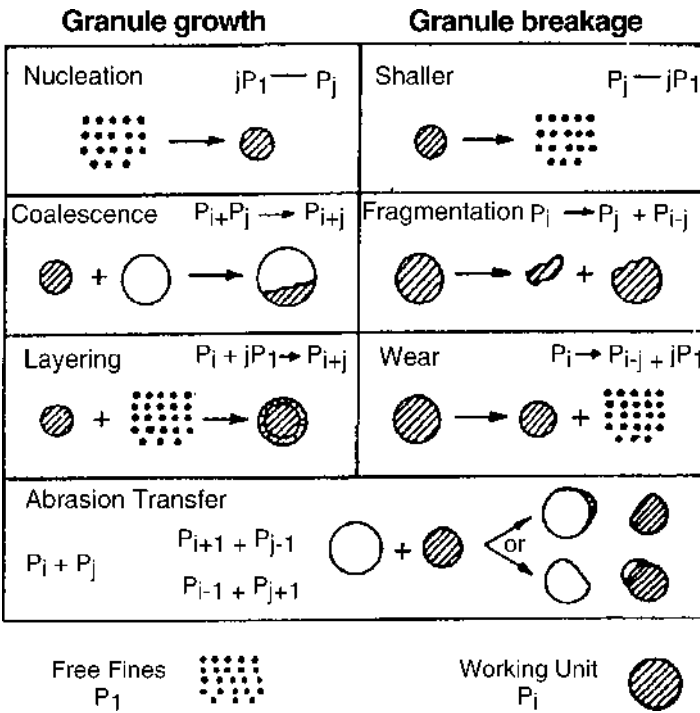
**Figure 9** Impact of granule density on disintegration:  $G_c$  is the strain energy release rate. (From Ref. 4.)

possible to reach a target change in dissolution without changes in formulation or material variables. Examples of key material variables affecting voidage would include feed primary particle size, inherent formulation bond strength, and binder solution viscosity, as discussed in detail in the following sections. Understanding this crucial interaction between operating and material variables is critical for successful formulation, and requires substantial collaboration between processing and formulation groups, and a clear knowledge of the effect of scale-up on this interaction.

### 1.5. Key Historical Investigations

A range of historical investigations has been undertaken involving the impact of operating variables on granulation behavior. As a review, see Refs. 3–5,11–13. Typical variables have included the effects of bed hydrodynamics and agitation intensity, pan angle and speed, fluid-bed excess gas velocity, mixer impeller and chopper speeds, drum rotation speed, spray method, drop size, nozzle location, and binder and solvent feed rates. While such studies are important, their general application and utility to studies beyond the cited formulations and process conditions can be severely limited. Often the state of mixing, moisture distribution and rates, and material properties such as formulation size distribution, powder frictional properties, and solution viscosity are insufficiently defined. As such, these results should be used judiciously and with care. Often even the directions of the impact of operating variables on granule properties are altered by formulation changes.

Two key pieces of historical investigation require mention, as the approach developed here stems heavily from this work. The first involves growth and breakage mechanisms, which control the evolution of the granule size distribution (14), as



**Figure 10** Growth and breakage mechanisms in granulation processes. (From Ref. 14.)

illustrated in Fig. 10. These include the nucleation of fine powder to form initial primary granules, the coalescence of existing granules, and the layering of raw material onto previously formed nuclei or granules. Granules may simultaneously be compacted by consolidation and reduced in size by breakage. There are strong interactions between these rate processes. In addition, these mechanisms in various forms have been incorporated into population-balance modeling to predict granule size in the work of Kapur and Sastry (14–19) (Chapter 23 for details). Given the progress made in connecting rate constants to formulation properties, the utility of population-balance modeling has increased substantially.

The second important area of contribution involves the work of Rumpf (20,21) and Ausburger and Vuppala (22), which studied the impact of interparticle force  $H$  on granule static tensile strength, or

$$\sigma_T = \frac{9}{8} \left( \frac{1 - \varepsilon}{\varepsilon} \right) \frac{H}{a^2} = A \left( \frac{1 - \varepsilon}{\varepsilon} \right) \frac{\gamma \cos \theta}{a} \quad \text{with} \begin{cases} A = 9/4 & \text{for pendular state} \\ A = 6 & \text{for capillary state} \end{cases} \quad (1.2)$$

Forces of a variety of forms were studied, including viscous, semisolid, solid, electrostatic, and van der Waals forces. Of particular importance was the contribution of pendular bridge force arising from surface tension to granule tensile strength. Capillary pressure deficiency due to the curvature of the pendular bridge in addition to a contact line force results in an interparticle force, as highlighted in Figure 11 (here, interparticle velocity  $U=0$ ). This force summed over the granule area results in a granule static strength, which is a function of pore saturation  $S$  as experimentally plotted. The states of pore filling have been defined as pendular (single bridges),



strength, and attrition resistance may be influenced as well. Preferential wetting of certain formulation ingredients can cause component segregation with granule size. An extensive review of wetting research may be found in Litster and Ennis (5), Parfitt (23), and Hapgood (24), with a summary of references given in Table 3.

## 2.2. Mechanics of the Wetting Rate Process

As outlined previously, wetting is the first stage in wet granulation involving liquid binder distribution to the feed powder. There are two extremes: (1) liquid drop size is large compared to unit or primary particle size of the feed and (2) particle size is large compared to the drop size.

As depicted in Figure 12 for the first case of fine feeds compared to drop size, the wetting process consists of several important steps. First, droplets are formed related to spray distribution, or spray flux defined as the wetting area of the bed per unit time. Important operating variables include nozzle position, spray area, spray rate, and drop size. Second, droplets impact and coalesce on the powder bed surface if mixing or wet-in time is slow. Third, droplets spread and penetrate into the moving powder bed to form loose nuclei, again coalescing if wet-in is slow. In the case of high-shear processes, shear forces break down overwet clumps, also producing nuclei.

For the second case of small drop size compared to the primary particle size, the liquid will coat the particles as depicted in Figure 13. Coating is produced by collisions between the drop and the particle followed by spreading of the liquid over the particle surface. If the particle is porous, then liquid will also be sucked into the pores by capillary action. The wetting dynamics control the distribution of coating material, which has a strong influence on the later stages of growth as well as coating quality.

## 2.3. Methods of Measurement

Methods of characterizing the rate process of wetting include four approaches as illustrated in Table 4. The first considers the ability of a drop to spread across the powder. This approach involves the measurement of a contact angle of a drop on a powder compact, given by the Young–Dupré equation, or

$$\gamma^{sv} - \gamma^{sl} = \gamma^{lv} \cos \theta \quad (2.1)$$

where  $\gamma^{sv}$ ,  $\gamma^{sl}$ ,  $\gamma^{lv}$  are the solid–vapor, solid–liquid, and liquid–vapor interfacial energies, respectively, and  $\theta$  is measured through the liquid. In the limit of  $\gamma^{sv} - \gamma^{sl} \geq \gamma^{lv}$ , the contact angle equals  $0^\circ$  and the fluid *spreads* on the solid. The extent of wetting is controlled by the group  $\gamma^{lv} \cos \theta$ , which is referred to as *adhesion tension*. Sessile drop studies of contact angle can be performed on powder compacts in the same way as on planar surfaces. Methods involve the (1) direct measurement of the contact angle from the tangent to the air–binder interface, (2) solution of the Laplace–Young equation involving the contact angle as a boundary condition, or (3) indirect calculations of the contact angle from measurements of, e.g., drop height. The compact can either be saturated with the fluid for static measurements, or dynamic measurements may be made through a computer imaging goniometer, as depicted in Figure 14. For granulation processes, the dynamics of wetting are often crucial, requiring that powders be compared on the basis of a short time scale, dynamic contact angle.

**Table 3** Summary of Wetting Research Contributions

Workers (Year)	Materials	Equipment	Investigated
Schaefer and Wörts (1978)	Lactose and maize starch powder with gelatine, PVP, and MCC binders	Fluid bed	Drop size
Schaafsma et al. (1999)	Lactose powder with water and 3–8% PVP solution binders	Packed bed in petri dish	Drop size
Waldie (1991)	Lactose and ballotini powders with water and 5% PVP solution	Fluid bed	Drop size
Watano et al. (1994)	Lactose and cornstarch with water	Hybrid fluid bed with agitator	Drop size, binder distribution
Holm et al. (1983, 1984)	Lactose and calcium hydrogen phosphate with water and 10–15% PVP solution	High-shear mixer	Drop size, binder distribution, and shear forces
Aulton and Banks (1979)	Lactose and salicylic acid powder with water	Fluid bed	Contact angle
Gluba et al. (1990)	Talcum, chalk, and kaolin powder combinations with water	Drum	Contact angle
Jaiyeoba and Spring (1980)	Lactose, boric acid, kaolin, suphanilamide, and salicylic acid powders with water.	Fluid bed	Contact angle
Krycer and Pope (1983)	Paracetamol powder with HPMC, PVP, and water	Fluid bed	Spreading coefficients
Zajic and Buckton (1990)	Methycellulose powder with HPMC, PVP, and water	Mixer granulator	Spreading coefficients
Rankell et al. (1964)	Aluminium hydroxide and sucrose powder with water	Fluid bed	Binder addition rate, powder flux, spray zone
Heim and Antkowiak (1989)	Talc powder and water	Drum	Binder addition rate
Crooks and Schade (1978)	5% Phenylbutazone in lactose powder mix with 10% solution	Fluid bed	Binder addition rate
Kristensen and Schaefer (1994)	Lactose powder with PEG300 and PEG6000	High shear	Viscosity, binder dispersion, shear forces

*(Continued)*

**Table 3** Summary of Wetting Research Contributions (*Continued*)

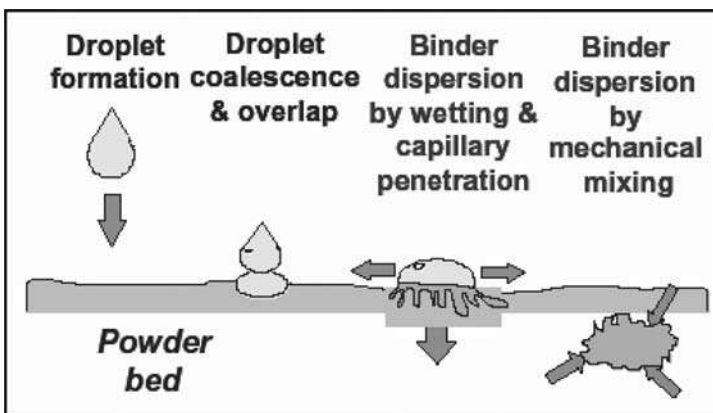
Workers (Year)	Materials	Equipment	Investigated
Schaefer et al. (1992)	Lactose powder with PEG300 and PEG6000	High shear	Viscosity, binder dispersion, shear forces, powder flux
Cartensen et al. (1976)	Lactose, sucrose, and starch powder mixed with water	High shear	Binder dispersion
Kokubo et al. (1996)	Lactose–cornstarch–MCC with HPMC 3cp	High–speed mixer	Powder flux
Davies and Gloor (1971)	Lactose, comstarch, magnesium stearate, gelatin, and benzene powder with gelatin solution	Fluid bed	Spray zone

Source: From Ref. 5.

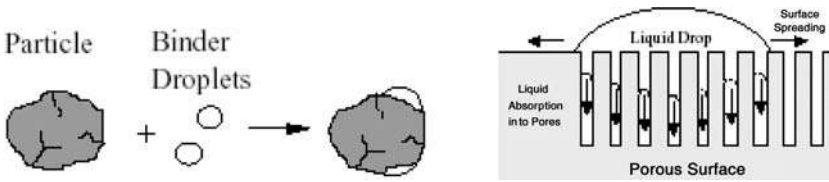
Important factors are the physical nature of the powder surface (particle size, pore size, porosity, environment, roughness, pretreatment). The dynamic wetting process is therefore influenced by the rates of ingredient dissolution and surfactant adsorption and desorption kinetics (25).

The second approach to characterize wetting considers the ability of the fluid to penetrate a powder bed, as illustrated in [Figure 15](#). It involves the measurement of the extent and rate of fluid rise by capillary suction into a column of powder, better known as the *Washburn* test. Considering the powder to consist of capillaries of radius  $R$ , the equilibrium height of rise  $h_e$  is determined by equating capillary and gravimetric pressures, or

$$h_e = \frac{2\gamma^{lv} \cos \theta}{\Delta\rho g R} \quad (2.2)$$



**Figure 12** Stages of wetting for fine powder compared to drop size. (From Ref. 5.)



**Figure 13** Stages of wetting for coarse powder compared to drop size. (From Ref. 5.)

where  $\Delta\rho$  is the fluid density with respect to air,  $g$  is gravity, and  $\gamma^{lv} \cos \theta$  is the adhesion tension as before.

In addition to the equilibrium height of rise, the dynamics of penetration are particularly important. Ignoring gravity and equating viscous losses with the capillary pressure, the rate ( $dh/dt$ ) and dynamic height of rise  $h$  are given by

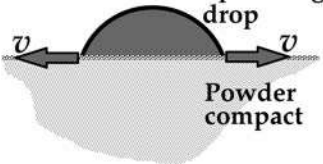
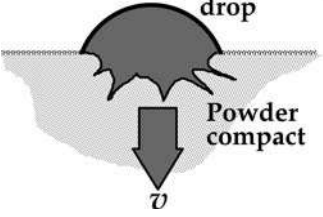
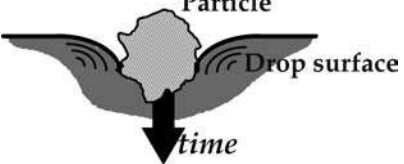
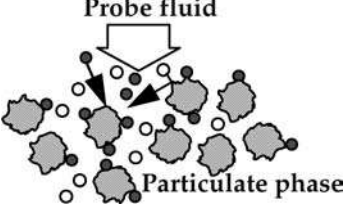
$$\frac{dh}{dt} = \frac{R\gamma^{lv} \cos \theta}{4\mu h} \quad \text{or} \quad h = \sqrt{\left[ \frac{R\gamma^{lv} \cos \theta}{2\mu} \right] t} \quad (2.3)$$

where  $t$  is time and  $\mu$  is binder fluid viscosity (23). The grouping of terms in brackets involve the material properties which control the dynamics of fluid penetration, namely, average pore radius, or tortuosity  $R$  (related to particle size and void distribution of the powder), adhesion tension, and binder viscosity. The rate of capillary fluid rise, or the rate of binding fluid penetration in wet granulation, increases with increasing pore radius (generally coarser powders with larger surface–volume average particle size), increasing adhesion tension (increased surface tension and decreased contact angle), and decreased binder viscosity.

The contact angle of a binder–particle system is not itself a primary thermodynamic quantity, but rather a reflection of individual interfacial energies (Eq. 2.1), which are a function of the molecular interactions of each phase with respect to one another. An interfacial energy may be broken down into its *dispersion* and *polar* components. These components reflect the chemical character of the interface, with the polar component due to hydrogen bonding and other polar interactions and the dispersion component due to van der Waals interactions. These components may be determined by the wetting tests described here, where a variety of solvents are chosen as the wetting fluids to probe specific molecular interactions (26). Interfacial energy is strongly influenced by trace impurities which arise in crystallization of the active ingredient, or other forms of processing such as grinding. It may be modified by judicious selection of surfactants (27). Charges may also exist at interfaces, as characterized by electrokinetic studies (28). The total solid–fluid interfacial energy (i.e., both dispersion and polar components) is also referred to as the *critical solid surface energy* of the particulate phase. It is equal to the surface tension of a fluid which just wets the solid with zero contact angle. This property of the particle feed may be determined by a third approach to characterize wetting, involving the penetration of particles into a series of fluids of varying surface tension (27,29), or by the variation of sediment height (30).

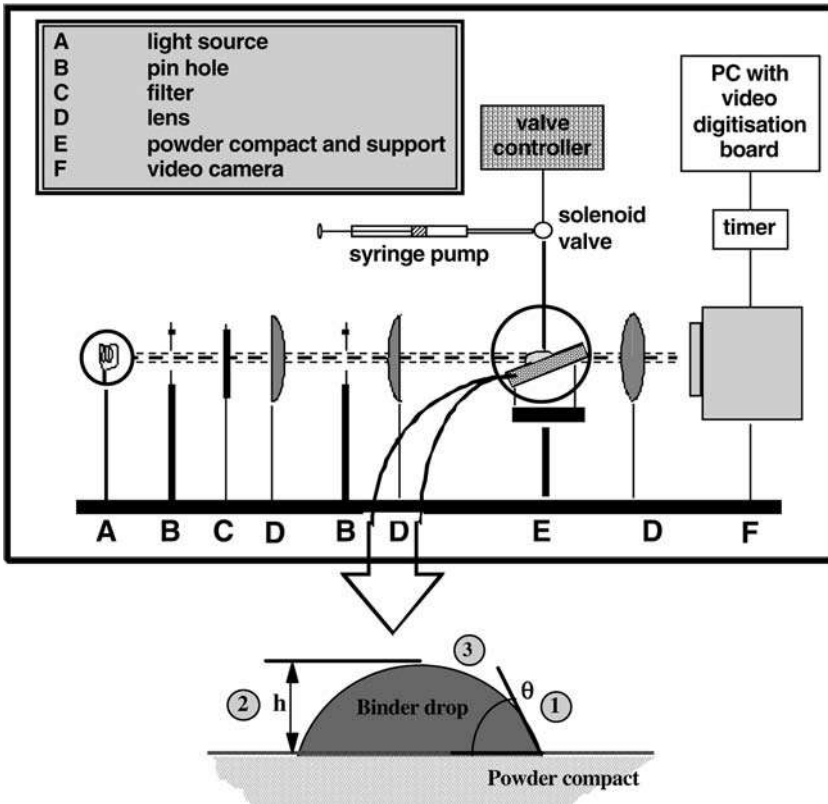
The last approach to characterizing wetting involves chemical probing of properties which control surface energy. As an example, inverse gas chromatography (IGC) uses the same principles and equipment as standard gas chromatography. In IGC, however, the mobile phase is composed of probe gas molecules that move

**Table 4** Methods of Characterizing Wetting Dynamics of Particulate Systems

Mechanism of wetting	Characterization method
Spreading drops on powder surface 	Contact angle goniometer: Contact angle Drop height or volume Spreading velocity References: Kossen, Heertjes. <i>Chem Eng Sci</i> 1965; 20:593 Pan et al. <i>Dynamic Properties of Interfaces and Association Structure</i> . New York: American Oil Chem Soc Press, 1995
Penetration of drops into powder bed 	Washburn test: Rate of penetration by height or volume Bartell cell: Capillary pressure difference References: Parfitt, ed. <i>Dispersion of Powders in Liquids</i> . Washburn: Elsevier Applied Science Publishers Ltd., 1986, and <i>Phys Rev</i> 1921; 17:273 Bartell, Osterhof. <i>Ind Eng Chem</i> 1927; 19:1277
Penetration of particles into fluid 	Flotation tests: Penetration time Sediment height Critical solid surface energy distribution References: Ayala R. Ph.D.Thesis, Chem. Eng., Carnegie Mellon University, 1985 Fuerstaneau et al. <i>Coll Surf</i> 1991; 60:127 Vargha-Butler. In: Botsaris, Glazman, eds. <i>Interfacial Phenomena in Coal Technology</i> , Chap. 2, 1994
Chemical probing of powder 	Inverse gas chromatography: Preferential adsorption with probe gases Electrokinetics: Zeta potential and charge Surfactant adsorption: Preferential adsorption with probe surfactants References: Lloyd et al., eds. <i>ACS Symposium Series</i> . Vol. 391. Washington, DC: ACS, 1989 Aveyard, Haydon. <i>An Introduction to the Principles of Surface Chemistry</i> . Cambridge University Press, 1973 Shaw. <i>Introduction to Colloid &amp; Surface Chemistry</i> . London: Butterworths & Co. Ltd., 1983

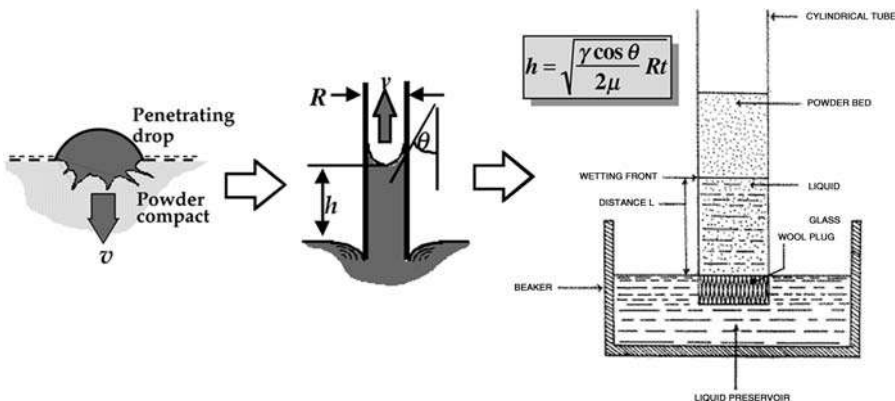
Source: From Refs. 1,2,5.





**Figure 14** Characterizing wetting by dynamic contact angle goniometry. (From Refs. 4,25.)

through a column packed with the powder of interest, which is the stationary phase. As the probe molecules travel through the packed column, they adsorb to and desorb from the powder. The rate and degree of this interaction is determined by the surface chemistry of the powder and the probe molecules. Since the surface chemistry of the probe molecules is known, this allows calculation of the surface chemistry (surface



**Figure 15** Characterizing wetting by Washburn test and capillary rise. (From Refs. 4,23.)

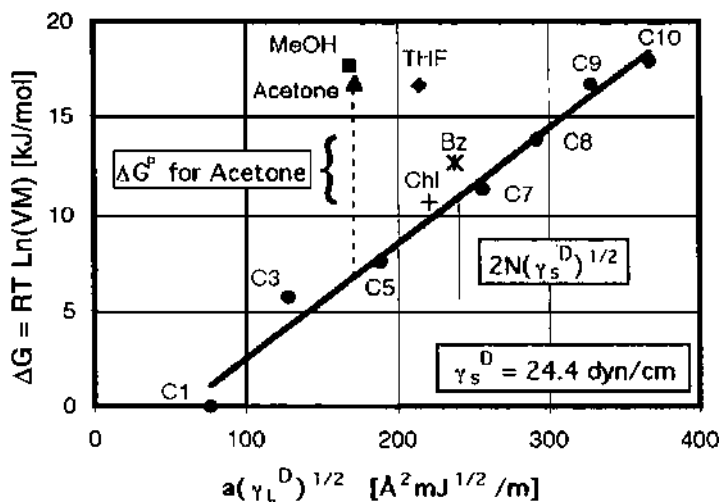


Figure 16 IGC retention times for glass powder. (From Refs. 4,5.)

energies) of the powder with the help of a series of plots of both alkane and various polar probes. A distinct advantage of IGC is the reproducible measurements of physical chemical surface properties which control adhesion tension.

The strength of the solid/liquid interactions determines the average retention time of a probe. Retention time data for each probe is converted into net retention volumes,  $V_N$ . The free energy of desorption is given by

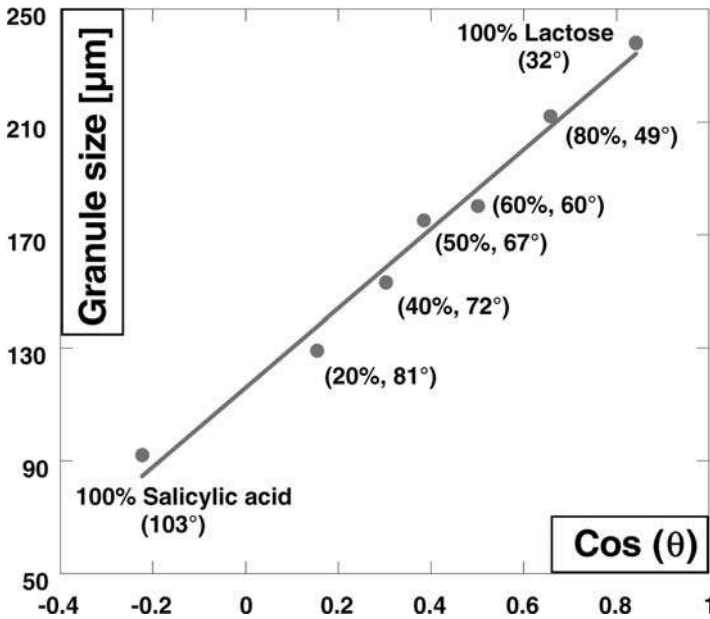
$$\Delta G = RT \ln V_N + c = 2Na \left( \sqrt{\gamma_S^D \gamma_L^D} + \sqrt{\gamma_S^P \gamma_L^P} \right) + c \quad (2.4)$$

where  $R$  is the universal gas constant,  $T$  is the column temperature,  $c$  is a system constant,  $N$  is Avagadro's number, and  $a$  is the surface area of a probe molecule. As illustrated in Figure 16, a plot of  $RT \ln V_N$  vs.  $a\sqrt{\gamma_L^D}$  should give a straight line for a series of alkanes, the slope of which allows determination of the solid's dispersive surface energy  $\gamma_S^D$ . Plotting  $RT \ln V_N$  vs.  $a\sqrt{\gamma_L^D}$  for the polar probes will give a point that is generally somewhere above the alkane reference line. The polar solid energy  $\gamma_S^P$  is then found from a plot of these deviations.

#### 2.4. Granulation Examples of the Impact of Wetting

Wetting dynamics has a pronounced influence on initial nuclei distribution formed from fine powder. As an example, the influence of contact angle on the average granule size formed in fluid-bed granulation is illustrated in Figure 17. Water contact angle was varied by changing the percentages of hydrophilic lactose and hydrophobic salicylic acid (31). Note that granule size in this study is actually nuclei size, since little growth has taken place in the process. Nuclei size is seen to improve with contact angle. In addition, the  $x$ -coordinate would more appropriately be replaced with adhesion tension. Aulton et al. (32) also demonstrated the influence of surfactant concentration on shifting nuclei size due to changes in adhesion tension.

Figure 18(A) illustrates an example of dynamic wetting, where a time series of drop profiles are imaged as a drop wets in to a formulation tablet. Note that the time



**Figure 17** The influence of contact angle on nuclei size formed in fluid-bed granulation of lactose/salicylic acid mixtures. Powder contact angle determined by goniometry and percent lactose of each formulation are given in parentheses. (From Ref. 31.)

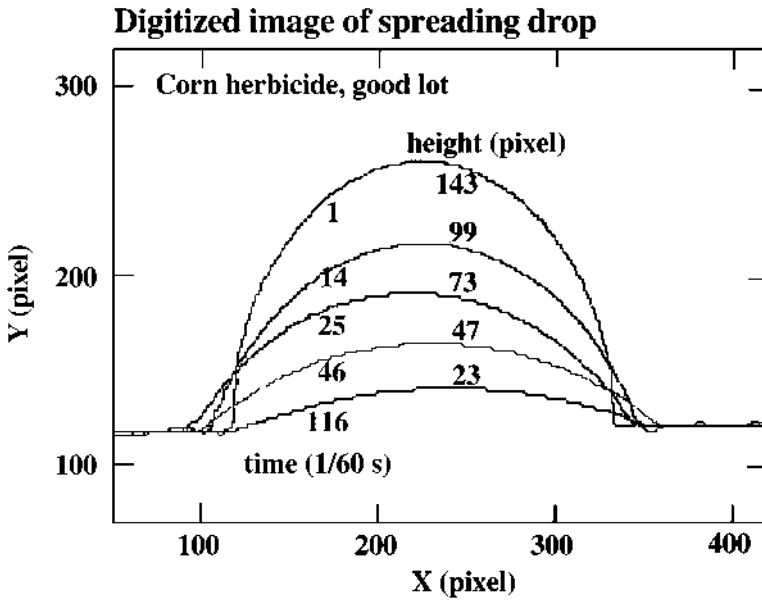
scale of wetting in this case is 2 sec, with nearly complete wet-in occurring in 1 sec. This particular formulation was granulated on a continuous pan system in excess of 2 tons/hr. [Figure 18\(B\)](#) compares differences in lots of the formulation. Note that a second lot—referred to as problem technical—experiences significantly degraded granule strength and requires production rates to be substantially reduced. This is associated with nearly twice the initial contact angle ( $120^\circ$ ) and slower spreading velocity when compared with the good technical. Poor wetting in practice can translate into reduced production rates to compensate for increased time for drops to work into the powder bed surface. Weaker granules are also often observed, since poor wet phase interfacial behavior translates in part to poor solid bond strength and high granule voidage. Note that differences in the lots are only observed over the first 0.25–0.5 sec, illustrating the importance of comparing dynamic behavior of formulations, after which time surfactant adsorption/desorption reduces the contact angle.

As an example of Washburn approaches as illustrated in [Figure 19](#), the effect of fluid penetration rate and the extent of penetration on granule size distribution for drum granulation was shown by Gluba et al. (Powder Hand. & Proc 1990; 2:323). Increasing penetration rate, as reflected by Eq. 2.3 increased granule size and decreased asymmetry of the granule size distribution.

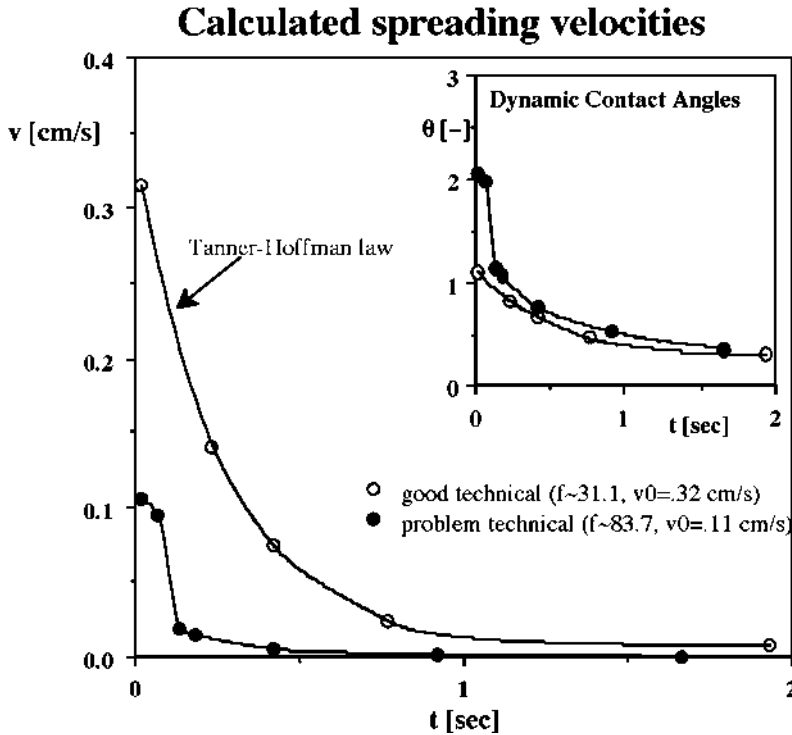
## 2.5. Regimes of Nucleation and Wetting

As previously depicted in [Figure 12](#), the wetting and nucleation process for fine powders consists of several important steps. First, droplets are formed related to spray distribution, or spray flux defined as the wetted area of the bed per unit time.

(A)



(B)



**Figure 18** Dynamic imaging of drop wetting, and its impact on continuous pan granulation: (A) Dynamic image of a drop wetting into a formulation, with good active ingredient. (B) Comparison of surface spreading velocity and dynamic contact angle vs. time for good and bad active ingredients or technical. Bad technical required reduced production rates. (From Ref. 4.)

Second, droplets impact and coalesce on the powder bed surface if mixing or wet-in time is slow. Third, droplets spread and penetrate into the moving powder bed to form loose nuclei, again coalescing, if wet-in is slow. In the case of high-shear processes, shear forces break down overwet clumps, also producing nuclei.

Two key features control this wetting and nucleation process. One is the time required for a drop to wet-in to the moving powder bed, in comparison to some circulation time of the process. As discussed previously, this wet-in time is strongly influenced by formulation properties (e.g., Eq. 2.3). The second is the actual spray rate or spray flux, in comparison to solids flux, or mixing rates. Spray flux is strongly influenced by manufacturing and process design.

One can envision that drop penetration time and spray flux define *regimes of nucleation* and wetting. If the wet-in is rapid and spray fluxes are low, individual drops will form discrete nuclei somewhat larger than the drop size, defining a *droplet controlled regime*. At the other extreme, if drop penetration is slow and spray flux is large, drop coalescence and pooling of binder material will occur throughout the powder bed, which must be broken down by mechanical dispersion. In the *mechanical dispersion regime* of nucleation, shear forces control the breakdown of wetting clumps, independent of drop distribution.

Falling between these two extreme regimes, drop overlap and coalescence occur to varying extent defining an *intermediate regime* of nucleation, being a function of penetration time and spray flux. To better define wetting, particularly in the sense of process engineering and scale-up, we will consider drop penetration or wet-in time and spray flux in greater detail.

Beginning with penetration time, Eq. 2.3 defines key formulation properties controlling capillary rise in powder beds. From considering a distribution of macro- and micropores in the moving powder bed, as shown in [Figure 20](#), Hapgood (24) determined a total drop penetration time  $t_p$  of

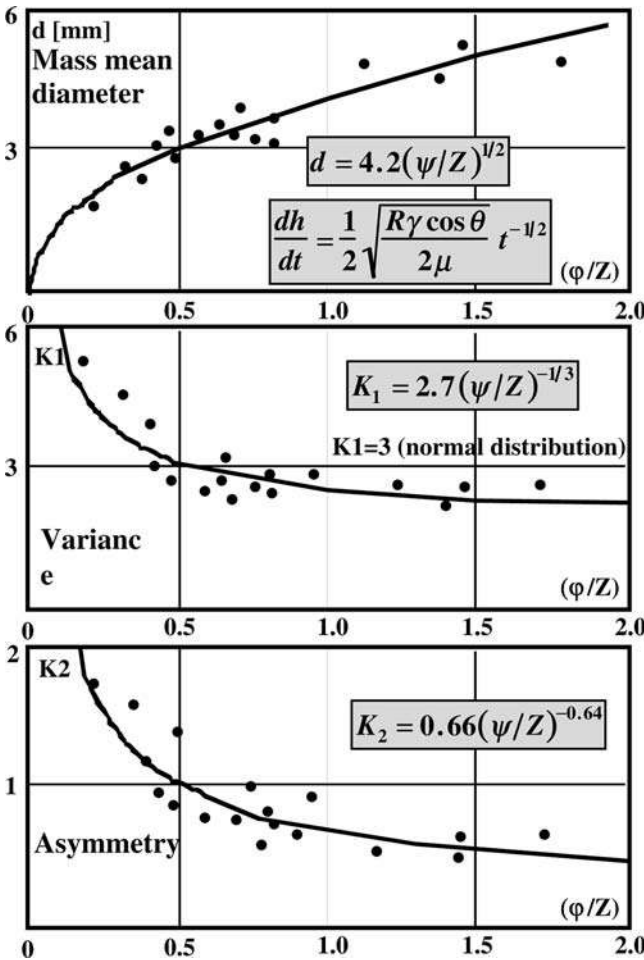
$$t_p = 1.35 \frac{V_d^{2/3}}{\varepsilon_{\text{eff}}^2} \left[ \frac{\mu}{R_{\text{eff}} \gamma \cos \theta} \right] \quad (2.5)$$

As shown previously, drop wet-in time decreases with increasing pore radius  $R_{\text{eff}}$ , decreasing binder viscosity and increasing adhesion tension. In addition, drop penetration time decreases with decreasing drop size  $V_d$  and increasing bed porosity  $\varepsilon_{\text{eff}}$ . Effective pore radius  $R_{\text{eff}}$  is related to the surface-volume average particle size  $d_{32}$ , particle shape, and effective porosity of packing  $\varepsilon_{\text{eff}}$  by

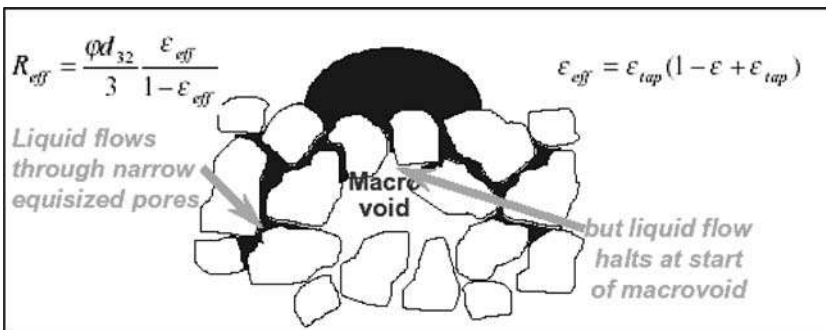
$$R_{\text{eff}} = \frac{\varphi d_{32}}{3} \left( \frac{\varepsilon_{\text{eff}}}{1 - \varepsilon_{\text{eff}}} \right) \quad (2.6)$$

To remain with a droplet controlled regime of nucleation, the penetration time given by Eq. 2.5 should be less than some characteristic circulation time  $t_c$  of the granulator in question. Circulation time is a function of mixing and bed weight, and can change with scale-up.

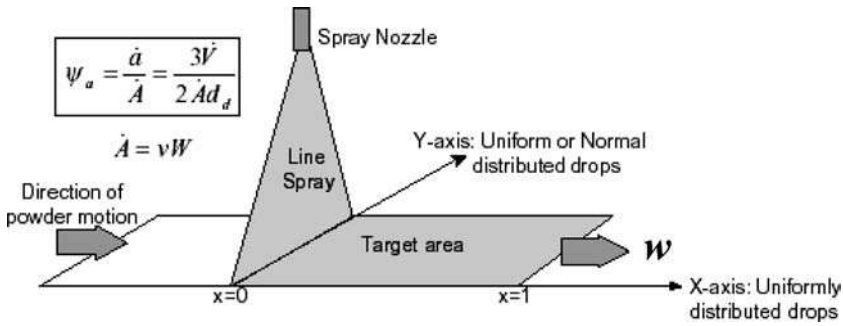
Now turning our attention to spray flux, consider [Figure 21](#) where an idealized powder bed of width  $B$  moves past a flat spray of spray rate  $(dV/dt)$  at a solids velocity of  $w$ . For a given spray rate, the number of drops is determined by drop volume, which in turn defines the drop area  $a$  per unit time which will be covered by the spray, giving a spray flux of:



**Figure 19** Influence of capillary penetration on drum granule size: Increasing penetration rate, as reflected by Eq. 2.3 increases granule size and decreases asymmetry of the granule size distribution.



**Figure 20** Drop penetration in a moving powder bed. (From Ref. 5.)



**Figure 21** Idealized flat spray zone in a spinning riffle granulator. (From Ref. 5.)

$$\frac{da}{dt} = \frac{dV/dt}{V_d} \left( \frac{\pi d_d^2}{4} \right) = \frac{3}{2} \frac{(dV/dt)}{d_d} \tag{2.7}$$

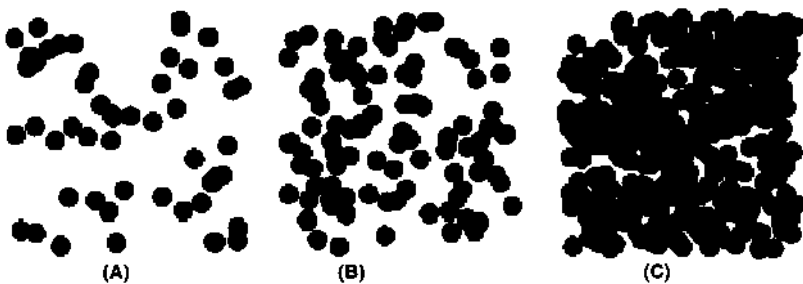
As droplets contact the powder bed at a certain rate, the powder moves past the spray zone at its own velocity, or at solids flux given for this simple example by

$$\frac{dA}{dt} = Bw \tag{2.8}$$

The ratio of the droplet spray flux to the solids flux defines a dimensionless spray flux given by

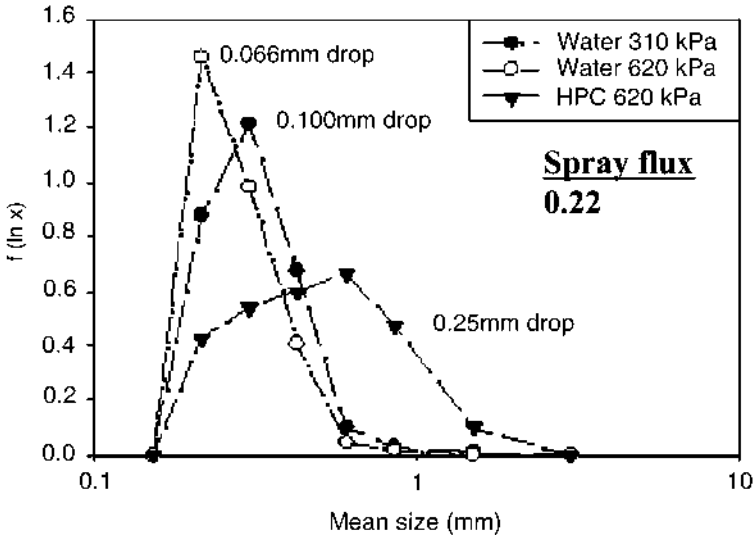
$$\psi_a = \frac{(da/dt)}{(dA/dt)} = \frac{3}{2} \frac{(dV/dt)}{d_d(dA/dt)} \tag{2.9}$$

The dimensionless spray flux is the ratio of the rate at which wetted area is covered by droplets to the area of flux of powder through the spray zone, and is a measure of the density of drops falling on the powder surface. As with drop penetration time, it plays a role in defining the regimes of nucleation as illustrated in Figure 22 (5,23). For small spray flux ( $\psi_a \approx 1$ ), drops will not overlap on contact and will form separate discrete nuclei for fast penetration time. For large spray flux ( $\psi_a \approx 1$ ), however, significant drop overlap occurs, forming nuclei much larger than drop size, and in the limit, independent of drop size.



**Figure 22** Monte-Carlo simulations of drop coverage. (From Ref. 5.)

### Effect of spray distribution on nuclei size distribution at low spray flux; lactose w/water & HPC spray.



**Figure 23** Effect of spray drop distribution (low spray flux) on nuclei distribution: Lactose feed powder in spinning granulator. (From Ref. 33.)

For the case of random drop deposition as described by a Poisson distribution, Hapgood (23) showed the fraction of surface covered by spray was given by

$$f_{\text{single}} = 1 - \exp(-\psi_a) \quad (2.10)$$

In addition, the fraction of single drops forming individual nuclei (assuming rapid drop penetration) vs. the number of agglomerates formed was given by

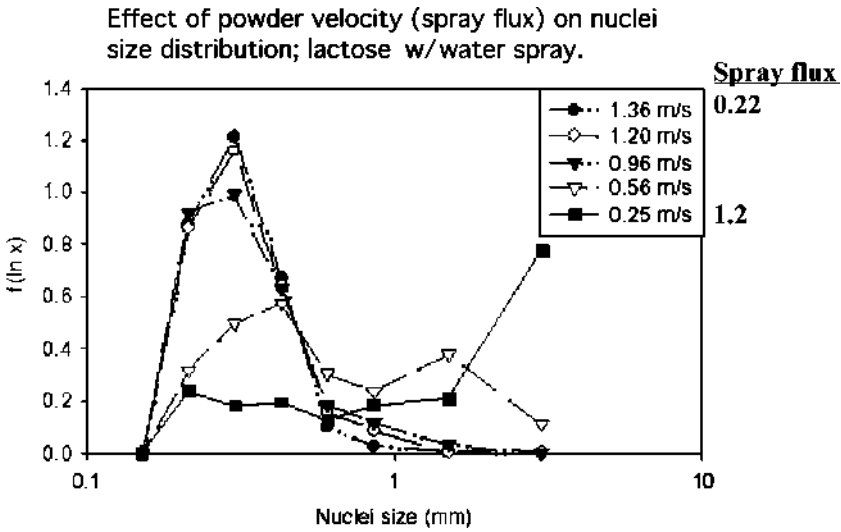
$$f_{\text{single}} = \exp(-4\psi_a) \quad (2.11)$$

$$f_{\text{agglom}} = 1 - \exp(-4\psi_a) \quad (2.12)$$

Examples of the above as applied to nucleation are depicted in Figures 23 and 24 and described by Litster et al. (33). Here, nuclei distribution was studied as a function of drop size and spray flux. Lactose was sprayed with a flat spray in a spinning riffle granulator, mimicking the geometry of Figure 21. For a moderate, intermediate spray flux of  $\psi_a = 0.22$ , a clear relationship is seen between nuclei size and spray distribution, with nuclei formed somewhat larger than drop size as shown in Figure 23. However, as the speed of the ruffles is slowed down (i.e., solids velocity and solids flux are decreased, and dimensionless spray flux increased), the nuclei distribution widens with the formation of agglomerates as depicted in Figure 24.

The spray flux captures the impact of equipment operating variables on nucleation, and as such is very useful for scale-up if nucleation rates and nuclei sizes are to be maintained constant. The overall impact of dimensionless spray flux on nucleation and agglomerate formation is illustrated in Figure 25, with agglomerates increasing with increased spray flux as clearly governed by Eq. 2.12 for the case of rapid drop penetration.



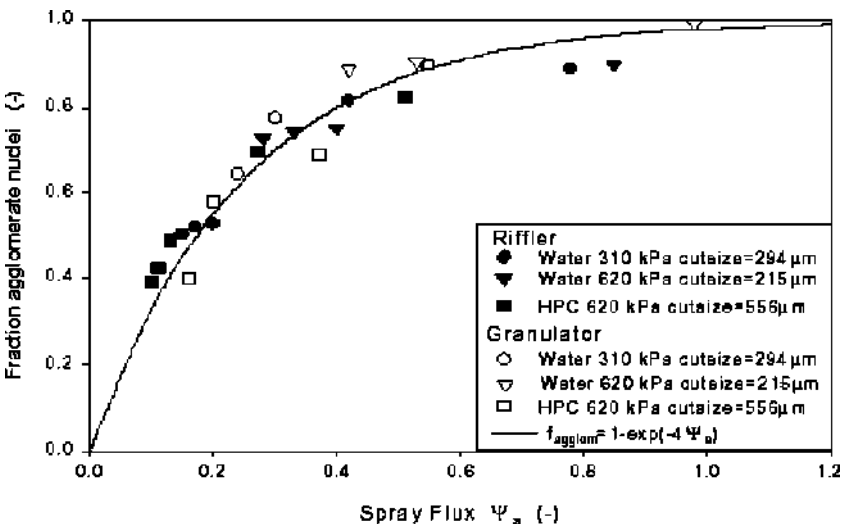


**Figure 24** Effect of powder velocity (variable spray flux—water) on nuclei distribution: Lactose feed powder in spinning granulator. (From Ref. 33.)

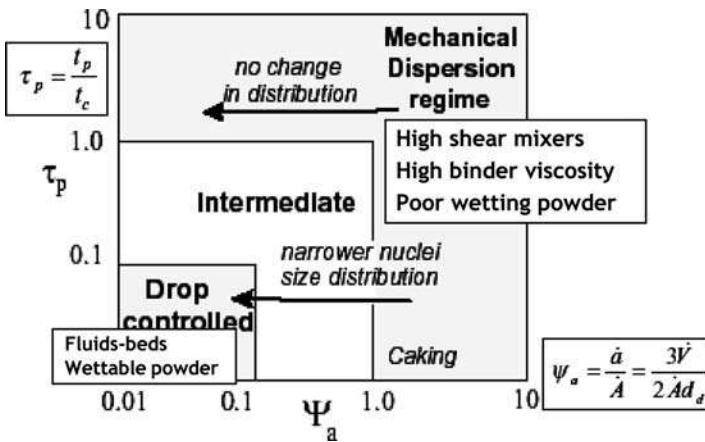
The regimes of nucleation may now be defined, as depicted in Figure 26 with the help of dimensionless drop penetration time  $\tau_p$  and spray flux  $\psi_a$ , or

$$\tau_p = \frac{t_p}{t_c} = \frac{\text{penetration time}}{\text{circulation time}} \quad \text{and} \quad \psi_a = \frac{(da/dt)}{(dA/dt)} = \frac{\text{spray flux}}{\text{solids flux}} \quad (2.13)$$

A *droplet controlled nucleation regime* occurs when there is both low spray flux—relatively few drops overlap—and fast droplet penetration—drops wet into



**Figure 25** Agglomerate formation vs. spray flux: Lactose powder with water and HPLC solutions. (From Ref. 5.)



**Figure 26** A possible regime map of nucleation, relating spray flux, solids mixing (solids flux and circulation time), and formulation properties. (From Refs. 5,24.)

the bed completely before bed mixing allows further drop contact. Nuclei will be formed of the order of drop size.

A *mechanical dispersion regime* occurs at the other extreme of high spray flux—giving large drop overlap and coalescence, and large drop penetration times, promoted by poor wet-in rates and slow circulation times and poor mixing. In this regime, nucleation and binder dispersion occur by mechanical agitation. Viscous, poorly wetting binders are slow to flow through pores in the powder bed in the case of poor penetration time. Drop coalescence on the powder surface occurs (also known as “pooling”) creating very broad nuclei size distributions. Binder solution delivery method (drop size, nozzle height) typically has minimal effect on the nuclei size distribution, though interfacial properties may affect nuclei and final granule strength.

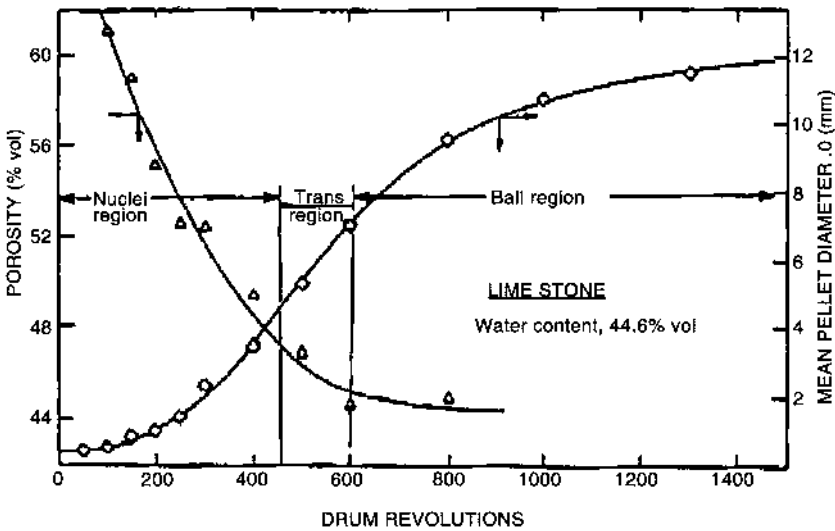
An *intermediate regime* exists for moderate drop penetration times and moderate spray flux, with the resulting nuclei regime narrowing with decreases in both.

There are several implications with regard to the nucleation regime map of Figure 26 with regard to trouble shooting of wetting and nucleation problems. If drop penetration times are large, making adjustments to spray may not be sufficiently narrow granule size distributions if remaining in the mechanical regime. Significant changes to wetting and nucleation only occur if changes take the system across a regime boundary. This can occur in an undesirable way if processes are not scaled, with due attention to remaining in the drop controlled regime.

### 3. GRANULE GROWTH AND CONSOLIDATION

#### 3.1. Overview

As previously outlined in Figures 4 and 10, the evolution of the granule size distribution of a particulate feed in a granulation process is controlled by several mechanisms, including wetting, nucleation, and coating; granule coalescence and consolidation; and granule breakage. Nucleation of fine powders and coating of existing granules by the fluid phase have been discussed in the previous section.



**Figure 27** Granule porosity and mean (pellet) size: Typical regimes of granule growth and consolidation. (Adapted from Refs. 15–19.)

Breakage mechanisms will be treated in the following section. Here, we focus particularly on growth and consolidation mechanisms.

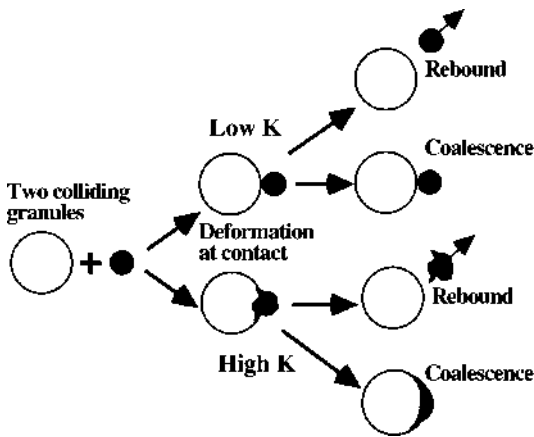
Granule growth includes the *coalescence* of existing granules as well as the *layering* of fine powder onto previously formed nuclei or granules. The breakdown of wet clumps into a stable nuclei distribution can also be included among coalescence mechanisms. As granules grow by coalescence, they are simultaneously compacted by *consolidation* mechanisms, which reduce internal granule voidage or porosity.

There are strong interactions between these rate processes, as illustrated in Figure 27 for the case of drum granulation of fine feed. Here, granule size is illustrated to progress through three stages of growth, including rapid, exponential growth in the initial *nucleation* stage, followed by linear growth in the *transition* stage, finishing with very slow growth in a final *balling* stage. Simultaneously with growth, granule porosity or voidage is seen to decrease with time as the granules are compacted. Granule growth and consolidation are intimately connected; increases in granule size are shown here to be associated with a decrease in granule porosity. This is a dominant theme in wet granulation.

As originally outlined in Ennis (3), these growth patterns are common throughout fluidized-bed, drum, pan, and high-shear mixer processes for a variety of formulations. Specific mechanisms of growth may dominate for a process—sometimes to the exclusion of others (4,5,11,12). However, what all processes have in common is that the prevailing mechanisms are dictated by a balance of critical particle level properties, which control formulation deformability, and operating variables which control the local level of shear, or bed agitation intensity.

### 3.2. Mechanics of the Growth Rate Process

In order for two colliding granules to coalesce rather than break up, the collisional kinetic energy must first be dissipated to prevent rebound as illustrated in Figure 28.



**Figure 28** Mechanisms of granule coalescence for low- and high-deformability systems: Rebound occurs for average granule sizes greater than the critical granule size  $D_c$ .  $K$  = deformability. (From Refs. 1,2.)

In addition, the strength of the bond must resist any subsequent breakup forces in the process. The ability of the granules to deform during processing may be referred to as the formulation's *deformability*, and deformability has a large effect on growth rate. Increases in deformability increase the bonding or contact area thereby dissipating and resisting breakup forces. From a balance of binding and separating forces and torque acting within the area of granule contact, Ouchiya and Tanaka (34) derived a critical limit of size above which coalescence becomes impossible, or a maximum growth limit given by

$$D_c = (AQ^{3\zeta/2}K^{3/2}\sigma_T)^{1/(4-(3/2)\eta)} \quad (3.1)$$

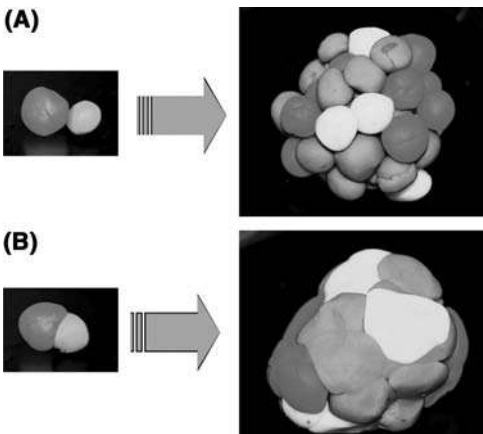
Here,  $K$  is deformability, a proportionality constant relating the maximum compressive force  $Q$  to the deformed contact area,  $A$  is a constant with units of  $[L^3/F]$ , which relates granule volume to impact compression force, and  $\sigma_T$  is the tensile strength of the granule bond. Granules are compacted as they collide. This expels pore fluid to the granule surface thereby increasing local liquid saturation in the contact area of colliding granules. This surface fluid (1) increases the tensile strength of the liquid bond  $\sigma_T$  and (2) increases surface plasticity and deformability  $K$ .

$D_c$  represents the largest granule that may be grown in a granulation process, and it is a harmonic average granule size. Therefore, it is possible for the collision of two large granules to be unsuccessful, their average being beyond this critical size, whereas the collision of a large and small granule leads to successful coalescence. The growth limit  $D_c$  is seen to increase with increased formulation deformability (which will be shown to be a strong function of moisture and primary particle size distribution), increased compressive forces (which are related to local shear levels in the process), and increased tensile forces (which are related to the interparticle forces previously discussed.) The parameters  $\zeta$  and  $\eta$  depend on the deformation mechanism within the contact area. For plastic deformation,  $\zeta = 1$ ,  $\eta = 0$ , and  $K \propto 1/H$  where  $H$  is hardness. For elastic, Hertzian deformation,  $\zeta = 2/3$ ,  $\eta = 2/3$ , and  $K \propto (1/E^*)^{2/3}$  where  $E^*$  is the reduced elastic modulus. Granule deformation is initially dominated by inelastic behavior of contacts during collision (35).

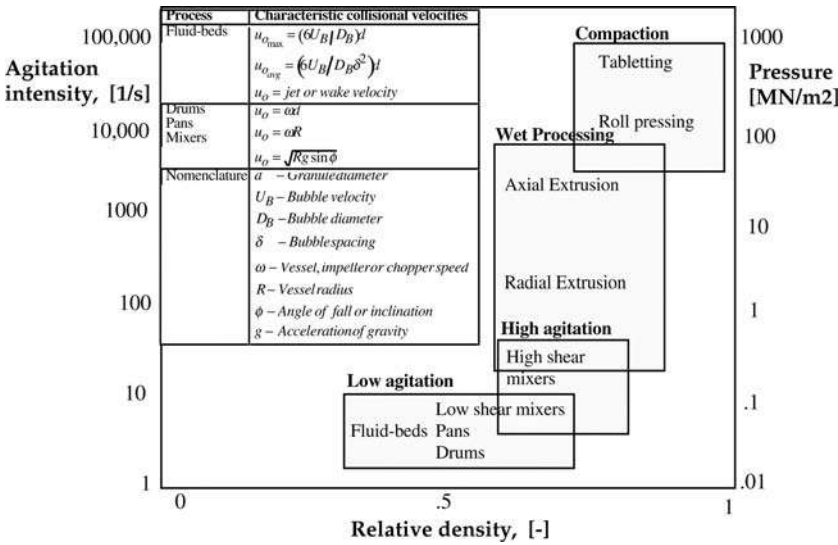
### 3.3. Types of Granule Growth

The importance of deformability to the growth process depends on *bed agitation intensity*. If little deformation takes place during granule collisions, the system is referred to as a *low deformability* or *low agitation intensity* process. This generally includes fluid bed, drum, and pan granulators. Growth is largely controlled by the extent of any surface fluid layer and surface deformability, with surface fluid playing a large role in dissipating collisional kinetic energy. Growth generally occurs at a faster time scale than overall granule deformation and consolidation. This is depicted in Figure 29, where smaller granules can still be distinguished as part of a larger granule structure, or a “pop-corn”-type appearance as often occurs in fluid-bed granulation. (Note that such a structure may not be observed if layering and nucleation alone dominate with little coalescence of large granules.) In this case, granule coalescence and consolidation have less interaction than they do with high deformability systems, making low deformability–low agitation systems easier to scale and model.

For high shear rates or bed agitation intensity, large granule deformation occurs during granule collisions, and granule growth and consolidation occur on the same time scale. Such a system is referred to as a *deformable* or *high agitation intensity* process, and it generally includes continuous pin and plow shear-type mixers, as well as batch high-shear pharmaceutical mixers. In these cases, substantial collisional kinetic energy is dissipated with deformation of the wet mass composing the granule. Rather than a “sticking” together process as often occurs in the low deformability process of fluid beds, granules are “smashed” together as with a high-shear mixer, and smaller granules are not distinguishable with the granule structure, as depicted in Figure 29. High-agitation, high-deformable processes generally produce denser granules than those with low deformability and low agitation intensity. In addition, the combined and competing effects of granule coalescence and consolidation make high-agitation processes difficult to model and scale. Both coalescence and consolidation increase with increase in shear and deformability, whereas as granules densify, they become less deformable, which works to lower coalescence in the later stages of growth.



**Figure 29** Granule structures resulting from (A) low- and (B) high-deformability systems, typical for fluid-bed and high-shear mixer granulators, respectively. (From Ref. 4.)



**Figure 30** Classification of agglomeration processes by agitation intensity and compaction pressure. (From Refs. 1,2,5.)

Bed agitation intensity is controlled by mechanical variables of the process such as fluid-bed excess gas velocity, or mixer impeller and chopper speed. Agitation intensity controls the relative collisional and shear velocities of granules within the process and therefore growth, breakage, consolidation, and final product density. Figure 30 summarizes typical characteristic velocities, agitation intensities, and compaction pressures, and product relative densities achieved for a variety of size-enlargement processes.

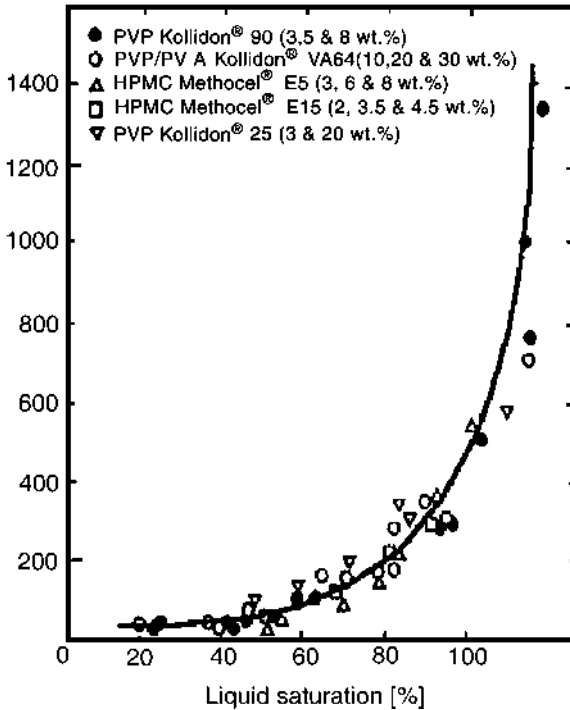
Last, it should be noted that the process or formulation itself cannot define whether it falls into a low- or high-agitation intensity process. As discussed more fully in the following sections, it is a function of both the level of shear as well as the formulation deformability. A very stiff formulation with low deformability may behave as a low deformability system in a high-shear mixer, or a very pliable formulation may act as a high-deformable system in a fluid-bed granulator.

### 3.4. Granule Deformability

Granule deformability—and hence  $D_c$ —is a strong function of moisture, as illustrated in Figure 31 by the marked increase in average granule size. Deformability  $K$  is related to both the *yield strength* of the material  $\sigma_y$ , i.e., the ability of the material to resist stresses, and the ability of the surface to be strained without degradation or rupture of the granule, with this maximum allowable *critical deformation strain* denoted by  $(\Delta L/L)_c$ . Figure 32 illustrates the low shear rate stress–strain behavior of agglomerates during compression as a function of liquid saturation, with strain denoted by  $\Delta L/L$ . In general, high deformability  $K$  requires low yield strength  $\sigma_y$  and high critical strain  $(\Delta L/L)_c$ . For this formulation, increasing moisture increases deformability by lowering interparticle frictional resistance, which also increases mean granule size (Fig. 31).

In most cases, granule deformability increases with increasing moisture, decreasing binder viscosity, decreasing surface tension, decreasing interparticle

Mean granule  
size,  $d_g$  [ $\mu\text{m}$ ]

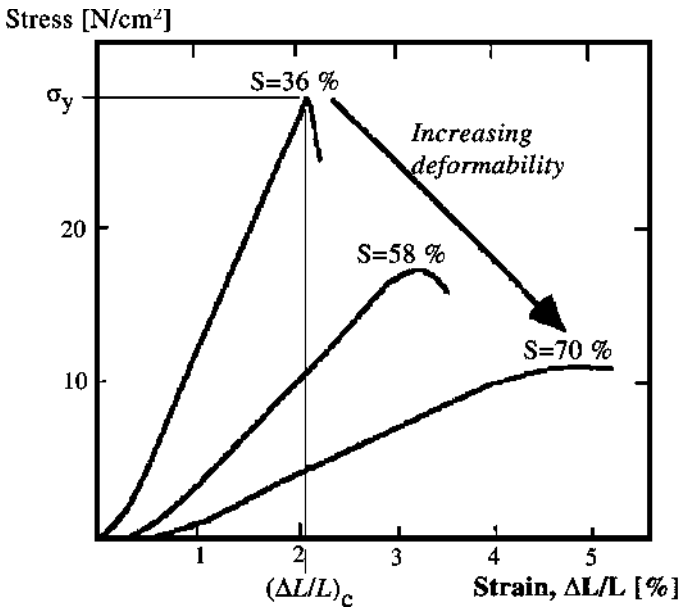


**Figure 31** Effect of granule saturation on mean granule diameter, indicating the marked increase in granule deformability. Mean granule diameter is a measure of the critical limit of size  $D_c$ . Granulation of calcium hydrogen phosphate–aqueous binder solutions. Fielder PMAT 25 VG mixer. (From Ref. 36.)

friction, and increasing average particle size (specifically  $d_{sv}$ , or the surface–volume mean size), as well as increasing bed agitation intensity. The important contributions of binder viscosity and friction to granule deformability and growth are illustrated by fractions of energy dissipated during a granule collision as depicted in Figure 33. Note that 60% of the energy is dissipated through viscous losses, with the majority of the remainder through interparticle friction. Very little is lost due to capillary forces controlled by surface tension. Therefore, modern approaches to granule coalescence rest in understanding the impact of granule deformability on growth, rather than the original capillary framework alone, as put forth by Rumpf (20,21) regarding pendular and funicular forces due to interparticle liquid bridges.

### 3.5. Interparticle Forces Due to Pendular Bridges

Interstitial fluid and the resulting pendular bridges play a large role in both granule growth and granule deformability. Pendular bridges between particles of which a granule is composed, give rise to capillary and viscous interparticle forces. These forces develop interparticle pressure, which also allows friction to act between point contacts (Fig. 34). Interparticle forces due to pendular bridges, and their impact on deformability, warrant further attention. Note that capillary forces for small contact



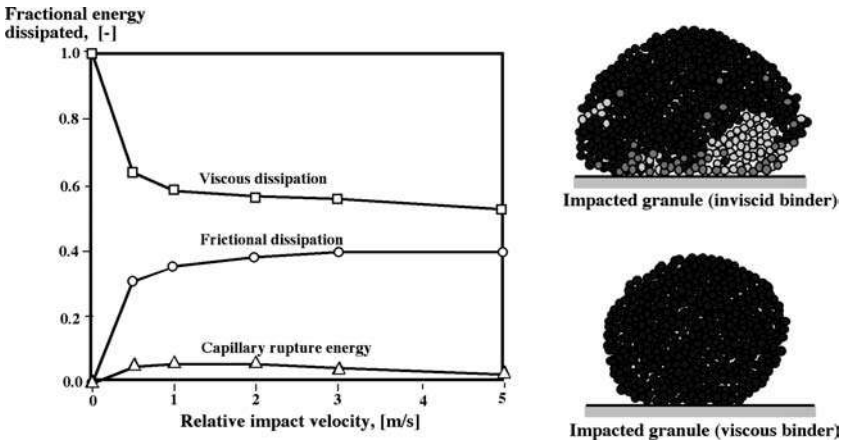
**Figure 32** The influence of sample saturation  $S$  on granule deformability: Deformation strain  $(\Delta L/L)$  is measured as a function of applied stress, with the peak stress and strain denoted by tensile strength  $\sigma_y$  and critical strain  $(\Delta L/L)_c$  of the material. Dicalcium phosphate with 15 wt% binding solution of PVP/PVA Kollidon® VA64. Fifty percent compact porosity. (From Ref. 37.)

angle attract particles (but repel for  $\theta > 90^\circ$ ), whereas viscous and frictional forces act to resist the direction of motion.

As shown in Figures 11 and 34, consider two spherical particles of radius  $a$  separated by a gap distance  $2h_0$  approaching one another at a velocity  $U$ . The two particles may represent two primary particles within the granule, in which case we are concerned about the contribution of interparticle forces to granule strength and deformability. Or they may represent two colliding granules, in which case we are concerned with the ability of the pendular bridge to dissipate granule kinetic energy and resist breakup forces in the granulation process. The two spheres are bound by a pendular bridge of viscosity  $\mu$ , density  $\rho$ , and surface tension  $\gamma$ . The pendular bridge consists of the binding fluid in the process, which includes the added solvent and any solubilized components. In some cases, it may also be desirable to include very fine solid components within the definition of the binding fluid, and, therefore, consider instead a suspension viscosity and surface tension. These material parameters vary on a local level throughout the process, and are also time dependent and a function of drying conditions.

For the case of a static liquid bridge (i.e.,  $U=0$ ) with perfect wetting, surface tension induces an attractive capillary force between the two particles due to a three-phase contact line force and a pressure deficiency arising from interfacial curvature. The impact of this static pendular bridge force on static granule strength has been studied and reported extensively (3,20–22). It is important to recognize that in most processes, however, the particles are moving relative to one another and, therefore, the bridge liquid is in motion. This gives rise to viscous resistance forces which can contribute significantly to the total bridge strength. The strength of both Newtonian



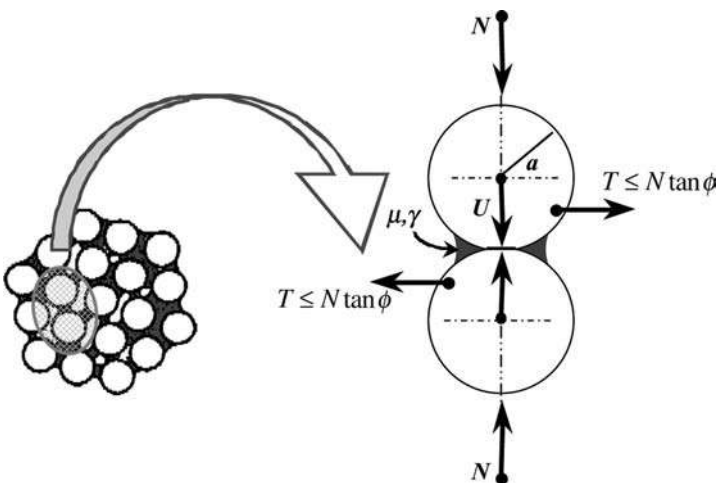


**Figure 33** Distribution of energy dissipation during agglomerate collisions, with granular simulations of wall impact for 128  $\mu$ s duration for inviscid and viscous binder agglomerates. (From Ref. 11.)

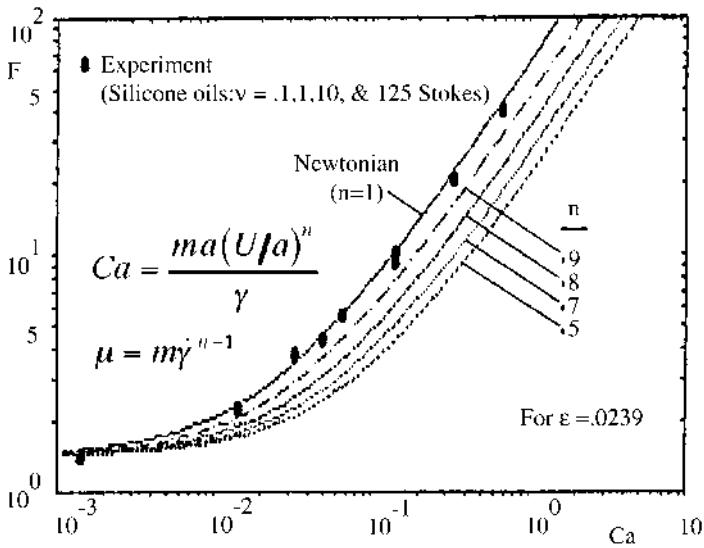
and non-Newtonian pendular bridges have been studied extensively (3,39,40). For Newtonian fluids (39), the dynamic strength was shown to be given by

$$\frac{F}{\pi\gamma a} = F_{\text{cap}} + F_{\text{vis}} = F_o + 3Ca/\varepsilon \quad \text{where} \quad \begin{cases} F_{\text{cap}} = (2 - 2H_o) \sin^2 \phi \\ F_{\text{vis}} = 3Ca/\varepsilon \\ Ca = \mu U/\gamma \end{cases} \quad (3.2)$$

Here, all forces have been made dimensionless with respect to a measure of the capillary force, or  $\pi\gamma a$ . Note that the bridge strength consists of two components.  $F_{\text{cap}}$  is the strength of a static capillary bridge, and is a function of curvature of



**Figure 34** Intersurface forces and granule deformability: Intersurface forces include capillary forces, viscous lubrication forces, and frictional forces. (From Ref. 4.)



**Figure 35** Maximum strength of a liquid bridge between two axial moving particles as a function of  $Ca$  for Newtonian and shear thinning fluids. (From Ref. 3.)

the interface  $H_o$  and the filling angle. In dimensional form, it is given by

$$F_{cap}^* = \pi\gamma a(2 - 2H_o) \sin^2 \varphi \tag{3.3}$$

$F_{vis}$  is the strength of a viscous, dynamic bridge, and is equivalent to the force between two spheres approaching one another in an infinite fluid. This force is a function of binder viscosity  $\mu$ , and the collision velocity  $U$ . Here,  $\varepsilon = 2h_o/a$  is gap distance, and not granule voidage. In dimensional form, the viscous force is given by

$$F_{vis}^* = 6\pi\mu Ua/\varepsilon \tag{3.4}$$

From Eq. 3.2, one finds that the dynamic bridge force begins with the static bridge strength—which is a constant independent of velocity (or  $Ca$ ), and then increases linearly with  $Ca$ , which is a capillary number representing the ratio of viscous ( $\pi\mu Ua$ ) to capillary ( $\pi\gamma a$ ) forces, and is proportional to velocity. This is confirmed experimentally as illustrated in Figure 35 for the case of two spheres approaching axially. Extensions of the theory have also been conducted for non-Newtonian fluids (shear thinning), shearing motions, particle roughness, wettability, and time-dependent drying binders. The reader is referred to Ennis (3,39) for additional details. Curves for non-Newtonian fluids are also included in Figure 35.

For small velocities, small binder viscosity, and large gap distances, the strength of the bridge will approximate a static pendular bridge, or  $F_{cap}$ , which is proportional to and increases with increases in surface tension. This force is equivalent to the static pendular force  $H$  previously given in Eq. 1.2 as studied by Rumpf (20,21) and Augsburgger and Vuppala (22). On the other hand, for large binder viscosities and velocities, or small gap distances, the bridge strength will approximately be equal to  $F_{vis}$ , which is proportional to and increases with increases in binder viscosity and velocity. This viscous force is singular in the gap distance and increases dramatically for small separation of the particles. It is important to note that as

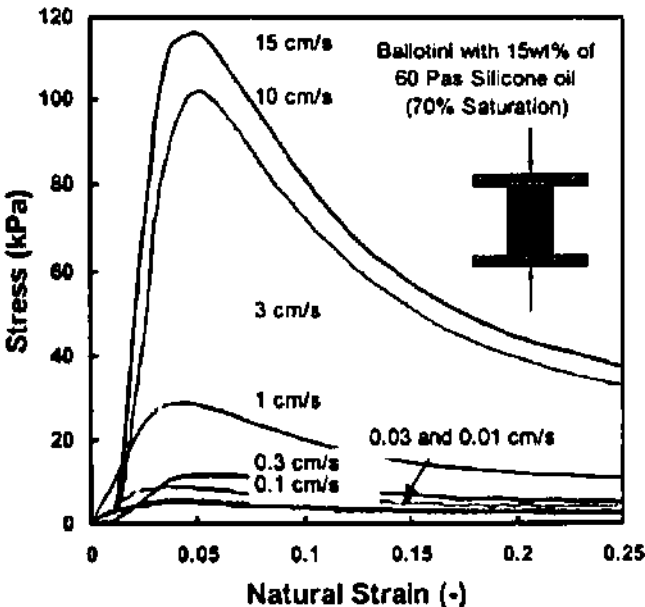
granules are consolidated, resulting in decreases in effective interparticle gap distance, and as binders dry, resulting in large increases in binder viscosity, the dynamic bridge strength can exceed the static strength by orders of magnitude.

### 3.6. Dynamic Wet Mass Rheology and Deformability Revisited

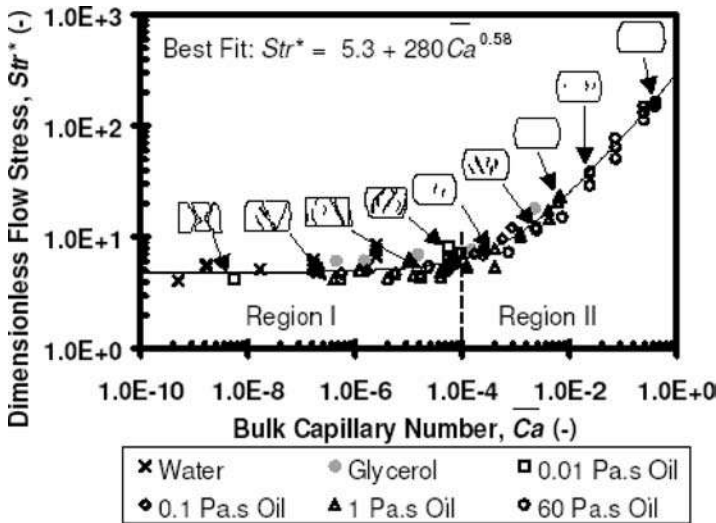
The yield stress of powder compacts has previously been reported in Figure 32 for the case of slow yielding. However, the dependence of interparticle forces on *shear rate* clearly impacts *wet mass rheology* and therefore deformability. Figure 36 illustrates the stress-strain response of compacts, demonstrating that the peak flow or yield stress increases proportionally with compression velocity (41). In fact, in a similar fashion to dynamic liquid bridge forces, the peak flow stress of wet unsaturated compacts (initially pendular state) can be seen to also increase with  $Ca$  as follows (Fig. 37):

$$\frac{\sigma_y^{\text{Peak}}}{\gamma/a} = \sigma_o + A \overline{Ca}^B \quad \text{where} \quad \begin{cases} \sigma_o = 5.0 - 5.3 \\ A = 280 - 320, B = 0.58 - 0.64 \\ \overline{Ca} = \mu \dot{\epsilon} a / \gamma \end{cases} \quad (3.5)$$

There are several important issues worth noting with regard to these results. First is the similarity between the strength of the assembly or compact given by Eq. 3.5 and the strength of the individual dynamic pendular bridge given by Eq. 3.2; both curves are similar in shape with a capillary number dependency. As with the pendular bridge, two regions may be defined. In region 1, for a bulk capillary number of  $\overline{Ca} < 10^{-4}$ , the strength or yield stress of the compact depends on the static pendular bridge, and therefore on surface tension, particle size, and liquid load-



**Figure 36** Typical compact stress response for fast compression vs. crosshead compression velocity for glass ballotini ( $d_{32} = 35 \mu\text{m}$ ) and compact diameter 20 mm, length 25 mm. (From Ref. 41.)



**Figure 37** Dimensionless peak flow stress of Fig. 36 vs. bulk capillary number, for various binder solutions. (From Ref. 41.)

ing. In region 2, for  $\overline{Ca} > 10^{-4}$ , the strength depends on the dynamic pendular bridge, and therefore on binder viscosity and strain rate, in addition to particle size.

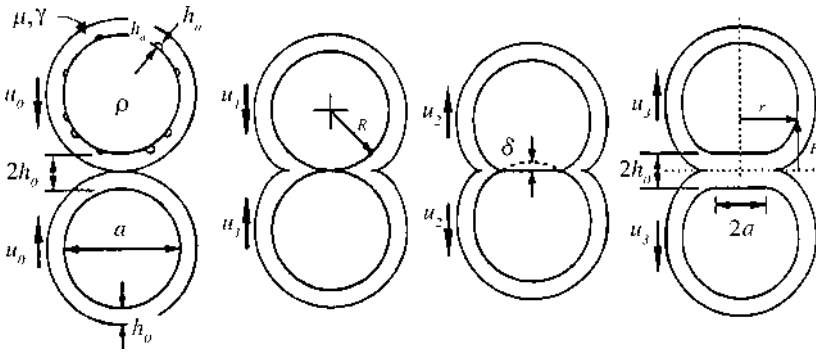
Second, the results of Figure 37 do not clearly depict the role of saturation and compact porosity, though these properties are known to affect strength. Decreases in compact porosity generally increases compact strength through increases in interparticle friction, whereas increases in saturation lower strength (e.g., Figure 32) (36,37,42). Hence, the curve of Figure 37 should be expected to shift with these variables, particularly since the viscous force for axial approach is singular in the interparticle gap distance (Eqs. 3.4).

Third, the static granule or assembly strength (Eq. 1.2), as originally developed by Rumpf (20,21) and Augsburger and Vuppala (22), is captured by the constant, low  $Ca$  value of the yield stress or

$$\sigma_y^{\text{Peak}} \approx \sigma_o(\gamma/a) \approx \frac{9}{8} \left( \frac{1-\varepsilon}{\varepsilon} \right) \frac{H}{a^2} \approx \frac{9}{4} \left( \frac{1-\varepsilon}{\varepsilon} \right) \frac{\gamma \cos \theta}{a} \quad \text{for } \overline{Ca} < 10^{-4} \quad (3.6)$$

Fourth, the mechanism of compact failure also depends on strain rate. Figure 38 illustrates schematically the crack behavior observed in compacts as a function of capillary number. At low  $Ca$ , compacts fail by brittle fracture with macroscopic crack propagation, whereas at high  $Ca$ , compacts fail by plastic flow.

Within the context of granulation, small yield stresses at low  $Ca$  may result in unsuccessful growth when these stresses are compared with large breakup forces. With increased yield stress comes stronger granules but also decreased deformability. Therefore, high strength might imply a low-deformability growth mechanism for low-shear processes such as a fluid bed. On the other hand, it might imply smaller growth rates for high-shear processes which are able to overcome this yield stress and bring about kneading action and plastic flow in the process. Therefore, it is important to bear in mind that increased liquid saturation may initially lower yield stress, allowing more plastic deformation during granule collisions. However, as granules grow and consolidate and decrease in voidage, they also strengthen and rise



**Figure 38** Collisions between surface wet granules, beginning with approach, and ending with separation. (From Refs. 3,5,43,44.) Note that no deformation takes place in the original Stokes model.

in yield stress, becoming less deformable with time and withstanding shear forces in the granulator. Hence, the desired granule strength and deformability is linked in a complex way to granulator shear forces and consolidation behavior.

### 3.7. Low-Agitation Intensity–Low-Deformability Growth

For those low-agitation processes or formulations which allow little granule deformation during granule collisions, consolidation of the granules occurs at a much slower rate than growth, and granule deformation can be ignored to a first approximation. The growth process can be modeled by the collision of two nearly stiff granules each coated by a liquid layer of thickness  $h$ . A pictorial depiction of a granule collision is illustrated in Figure 38. For the case of zero plastic deformation, the probability of successful coalescence as developed by Ennis and coworkers (3,43) is governed by a dimensionless energy, or Stokes number  $St$  given by

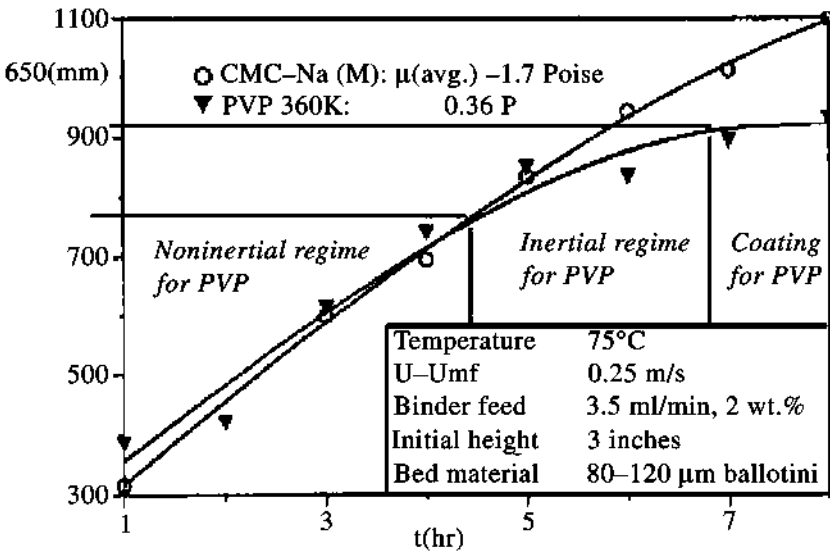
$$St = \frac{4\rho u_0 a}{9\mu} \tag{3.7}$$

where  $u_0$  is the relative collisional velocity of the granules,  $\rho$  is granule density,  $a$  is the harmonic average of granule diameter, and  $\mu$  is the solution phase binder viscosity. The Stokes number represents the ratio of initial collisional kinetic energy to the energy dissipated by viscous lubrication forces, and it is one measure of normalized bed agitation energy. Successful growth by coalescence or layering requires that

$$St < St^* \quad \text{where } St^* = \left(1 + \frac{1}{e_r}\right) \ln(h/h_a) \tag{3.8}$$

where  $St^*$  is a critical Stokes number representing the energy required for rebound. The binder layer thickness  $h$  is related to liquid loading,  $e_r$  is the coefficient of restitution of the granules, and  $h_a$  is a measure of surface roughness or asperities. The critical condition given by Eq. 3.8 controls the growth of low deformability systems. This criteria has also been extended to capillary coalescence (3) and for cases of plastic deformation (44).

Binder viscosity is a function of local temperature, collisional strain rate (for non-Newtonian binders), and binder concentration dictated by drying rate and local



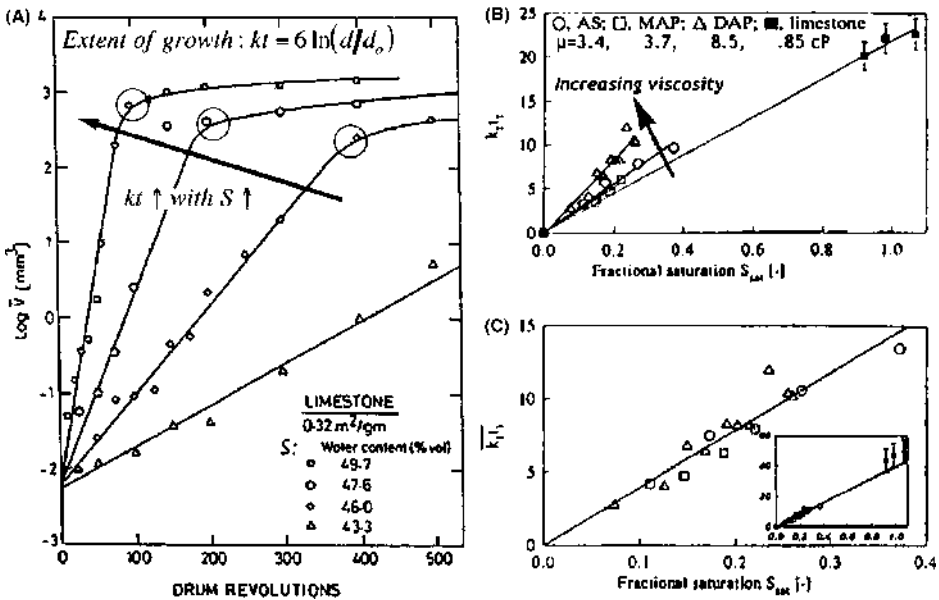
**Figure 39** Median granule diameter for fluid-bed granulation of ballotini with binders of different viscosity indicating regimes of growth. (From Refs. 3,43.)

mass transfer and local bed moisture. It can be controlled through judicious selection of binding and surfactant agents and measured by standard rheological techniques (45). The collisional velocity is a function of process design and operating variables, and is related to bed agitation intensity and mixing. Possible choices of  $u_0$  are summarized in Figure 30, and discussed more fully regarding scale-up in Chapter 18. Note that  $u_0$  is an interparticle *collisional* velocity, which is not necessarily the local average granular flow velocity.

Three regimes of granule growth may be identified for low-agitation intensity–low-deformability processes (3,43), as depicted for fluid-bed granulation in Figure 39, and outlined as follows:

*Noninertial regime:* For small granules or high binder viscosity lying within a noninertial regime of granulation, all values of  $St$  will lie below the critical value  $St^*$  and therefore all granule collisions result in successful growth provided binder is present. Growth rate is independent of granule kinetic energy, particle size, and binder viscosity (provided other rate processes are constant). Distribution of binding fluid and degree of mixing then control growth and, and this is strongly coupled with the rate process of wetting (see previous section). As shown in Figure 39, both binders have the same initial growth rate for similar spray rates, independent of binder viscosity. Increases in bed moisture (e.g., spray rate, drop rate) and increases in granule collisions in the presence of binder will increase the overall rate of growth. It must be borne in mind, however, that there is a 100% success of these collisions, since dissipation of energy far exceeds collisional kinetic energy.

*Inertial regime:* As granules grow in size, their collisional momentum increases, leading to localized regions in the process where  $St$  exceeds the critical value  $St^*$ . In this inertial regime of granulation, granule size, binder



**Figure 40** (A) Exponential growth in drum granulation reaching a growth limit  $d_{\max}$ , or maximum extent of growth  $(kt)_{\max}$ , which are functions of moisture saturation (15–19). (B) Maximum extent of noninertial growth  $(kt)_{\max}$  as a linear function of saturation of the powder feed and binder viscosity. (C) Maximum extent normalized for differences in binder viscosity, drum speed, granule density by Stokes number. (From Ref. 46.)

viscosity, and collision velocity determine the proportion of the bed in which granule rebound is possible. Increases in binder viscosity and decreases in agitation intensity increase the extent of granule growth—i.e., the largest granule that may be grown [e.g.,  $D_c$  of Eq. 3.1]. This is confirmed in Figure 39 with the CMC binder continuing to grow, whereas the PVP system with lower viscosity slows down in growth. Note that the rate of growth, however, is controlled by binder distribution and mixing, and not binder viscosity. For example, increasing binder viscosity will not affect growth rate, or initial granule size, but it will result in an increased growth limit.

*Coating regime:* When the spatial average of  $St$  exceeds  $St^*$ , growth is balanced by granule disruption or breakup, leading to the coating regime of granulation. Growth continues by coating of granules by binding fluid alone. The PVP system with lower viscosity is seen to reach its growth limit and therefore coating regime in Figure 39.

Transitions between granulation regimes depend on bed hydrodynamics. As demonstrated by Ennis et al. (3,4,43), granulation of an initially fine powder may exhibit characteristics of all three granulation regimes as time progresses, since  $St$  increases with increasing granule size. Implications and additional examples regarding the regime analysis are highlighted by Ennis (3,4,43). In particular, increases in fluid-bed excess gas velocity exhibit a similar but opposite effect on growth rate to binder viscosity; namely, it is observed to not affect growth rate in the initial Noninertial regime of growth, but instead lowers the growth limit in the inertial regime.

### 3.8. Example: Extent of Noninertial Growth

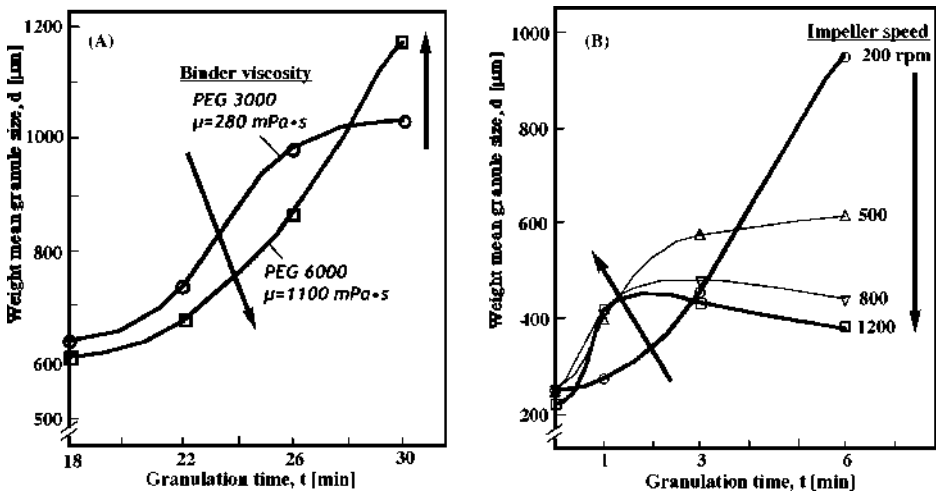
Growth by coalescence in granulation processes may be modeled by population balances (Chapter 21). It is necessary to determine both the mechanism and the kernel which describe growth. For fine powders within the noninertial regime of growth, all collisions result in successful coalescence provided binder is present. Coalescence occurs via a random, size independent kernel which is only a function of liquid loading  $y$ , as well as mixing, or

$$\beta(u, v) = k = k^*f(y) \quad (3.9)$$

For random growth and in the presence of sufficient binding fluid, it may be rigorously proven that the average granule size increases exponentially with time, or

$$d = d_0 e^{kt} \quad (3.10)$$

This exponential increase in size with time is confirmed experimentally in Figure 40, where increases in liquid loading  $f(y)$  increase growth rate. (Note that granule saturation  $S$  is connected to liquid loading  $y$  and porosity.) Based on the regime analysis work above, growth will continue in a process while the conditions of Eq. 3.8 are met, i.e., dissipation exceeds collisional kinetic energy. Examples of these growth limits are seen in the drum granulation work of Kapur (15–19) in Figure 40, as well as fluid beds (Fig. 39) and mixers (Fig. 41). It may be shown that the maximum extent of granulation  $(kt)_{\max}$  occurring within the noninertial regime is given by



**Figure 41** Granule diameter as a function of time for high-shear mixer granulation, illustrating the influence of deformability on growth behavior. Directions of increasing viscosity and impeller speed indicated by arrows. (A) Ten-liter melt granulation of lactose with 15 wt% binder and impeller speed of 1400 rpm for two different viscosity grades of polyethylene glycol binders. (B) Ten-liter vertical high-shear mixer granulation of dicalcium phosphate with 15 wt% binder solution of PVP/PVA Kollidon® VA64, liquid loading of 16.8 wt%, and chopper speed of 1000 rpm for varying impeller speed. (From Refs. 47,48.)



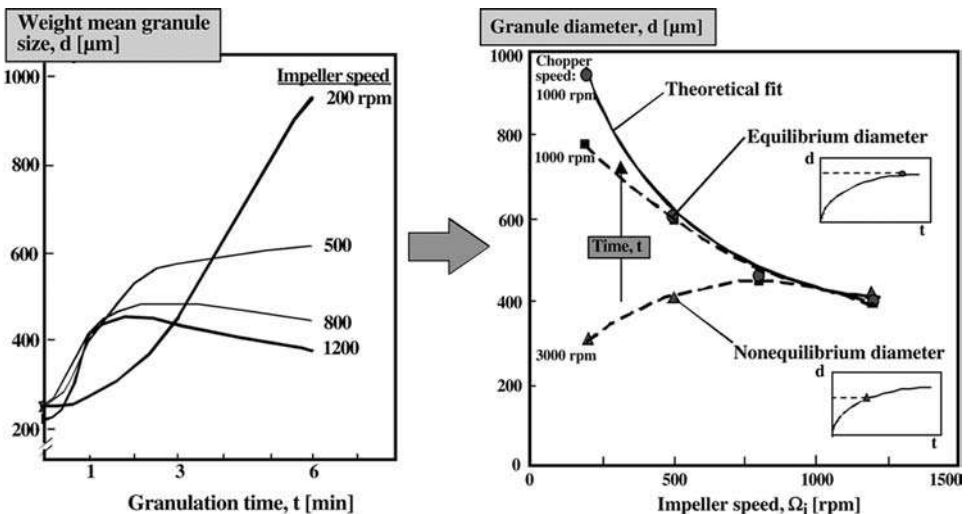
$$(kt)_{\max} = 6 \ln(St^*/St_0) f(y) \propto \ln\left(\frac{\mu}{\rho u_0 d_0}\right) \quad (3.11)$$

$St_0$  is the Stokes number based on initial nuclear diameter  $d_0$  (46). Extent  $(kt)_{\max}$  is taken as the logarithm of the growth limit in the first random stage of growth, or  $d_{\max}$ . The growth limits  $d_{\max}$  of Figure 40(A) are replotted as extents in Figure 40(B). Here,  $(kt)_{\max}$  is observed to depend linearly on liquid loading  $y$ . Therefore, the maximum granule size depends exponentially on liquid loading, as observed experimentally (Fig. 31).

From Eq. 3.11, it is possible to scale or normalize a variety of drum granulation data to a common drum speed and binder viscosity. Maximum granule size  $d_{\max}$  and extent  $(kt)_{\max}$  depend linearly and logarithmically, respectively, on binder viscosity and the inverse of agitation velocity. This is illustrated in Figure 40(B), where the slope of each formulation line depends linearly on binder viscosity. Figure 40 illustrates the normalization of extent  $(kt)_{\max}$  for the drum granulation of limestone and fertilizers, correcting for differences in binder viscosity, granule density, and drum rotation speed, with the data collapsing onto a common line following normalization.

### 3.9. High-Agitation Intensity–Deformable Growth

For high-agitation processes involving high-shear mixing or for readily deformable formulations, granule deformability, plastic deformation, and granule consolidation can no longer be neglected as they occur at the same rate as granule growth. Typical growth profiles for high-shear mixers are illustrated in Figure 41. Two stages of growth are evident, which reveal the possible effects of binder viscosity and impeller speed, as shown for data replotted vs. impeller speed in Figure 42. The initial, nonequilibrium stage of growth is controlled by granule deformability, and is of most



**Figure 42** Granule diameter as a function of impeller speed for both initial nonequilibrium and final equilibrium growth limit for high-shear mixer granulation (From Ref. 10,48.)

practical significance in manufacturing for high-shear mixers. Increases in  $St$  due to lower viscosity or higher impeller speed increase the rate of growth, since the system becomes more deformable and easier to knead into larger granule structures (e.g., Fig. 29). These effects are contrary to what is predicted from the Stokes analysis based on rigid, low-deformability granules, where high viscosity and low velocity increase the growth limit.

Growth continues until disruptive and growth forces are balanced in the process. This last equilibrium stage of growth represents a balance between dissipation and collisional kinetic energy, and so increases in  $St$  decrease the final granule size, as expected from the Stokes analysis. Note that the equilibrium granule diameter decreases with the inverse square root of the impeller speed, as it should based on  $St = St^*$ , with  $u_0 = a^*(du/dx) = \omega a$ .

The Stokes analysis is used to determine the effect of operating variables and binder viscosity on equilibrium growth, where disruptive and growth forces are balanced. In the early stages of growth for high-shear mixers, the Stokes analysis in its present form is inapplicable. Freshly formed, uncompacted granules are easily deformed, and as growth proceeds and consolidation of granules occur, they will surface harden and become more resistant to deformation. This increases the importance of the elasticity of the granule assembly. Therefore, in later stages of growth, older granules approach the ideal Stokes model of rigid collisions. In addition, the Stokes number controls in part the degree of deformation occurring during a collision since it represents the importance of collision kinetic energy in relation to viscous dissipation, although the exact dependence of deformation on  $St$  is presently unknown.

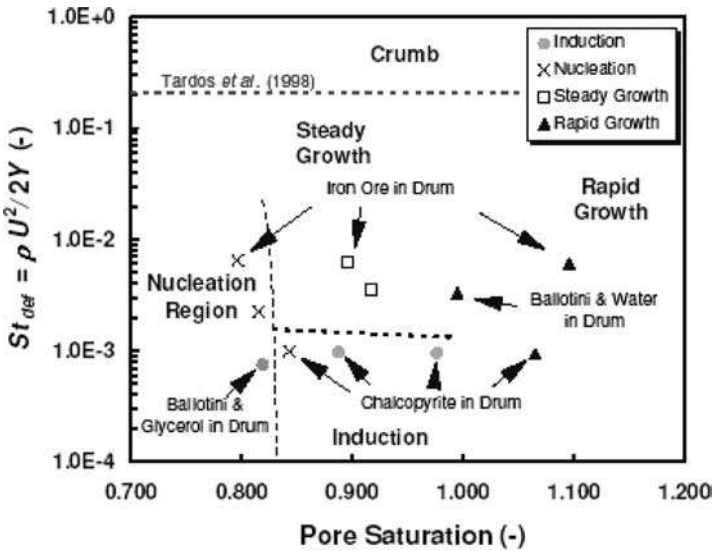
The Stokes coalescence criteria of Eq. 3.8 developed by Ennis must be generalized to account for substantial plastic deformation in order to treat the initial nonequilibrium stages of growth in high-agitation systems such as high-shear mixers. In this case, granule growth and deformation are controlled by a generalization of  $St$ , or a deformation Stokes number  $St_{\text{def}}$ , as originally defined by Tardos et al. (49,50):

$$St_{\text{def}} = \frac{\rho u_0^2}{\sigma_y} = \frac{\rho (du_0/dx)^2 d^2}{\sigma_y} \quad (3.12)$$

Viscosity has been replaced by a generalized form of plastic deformation controlled by the yield stress  $\sigma_y$ , which may be determined by compression experiments. As shown previously, yield stress is related to deformability of the wet mass, and is a function of shear rate, binder viscosity, and surface tension, primary particle size and friction, and saturation and voidage as previously given by Eq. 3.5 and Figures 32 and 37.

Critical conditions required for granule coalescence may be defined in terms of the viscous and deformation Stokes number, or  $St$  and  $St_{\text{def}}$ , respectively. These represent a complex generalization of the critical Stokes number given by Eq. 3.9, and are discussed in detail elsewhere (5,44).

An overall view of the impact of deformability on growth behavior may be gained from Figure 43, where types of granule growth are plotted vs. deformability in a regime map, and yield stress has been measured by compression experiments (51). Growth mechanism depends on the competing effects of high-shear promoting growth by deformation on the one hand and the breakup of granules giving a growth limit on the other. For high velocities, growth is not possible by deformation due to high shear, and the material remains in a crumb state. For low pore saturation,



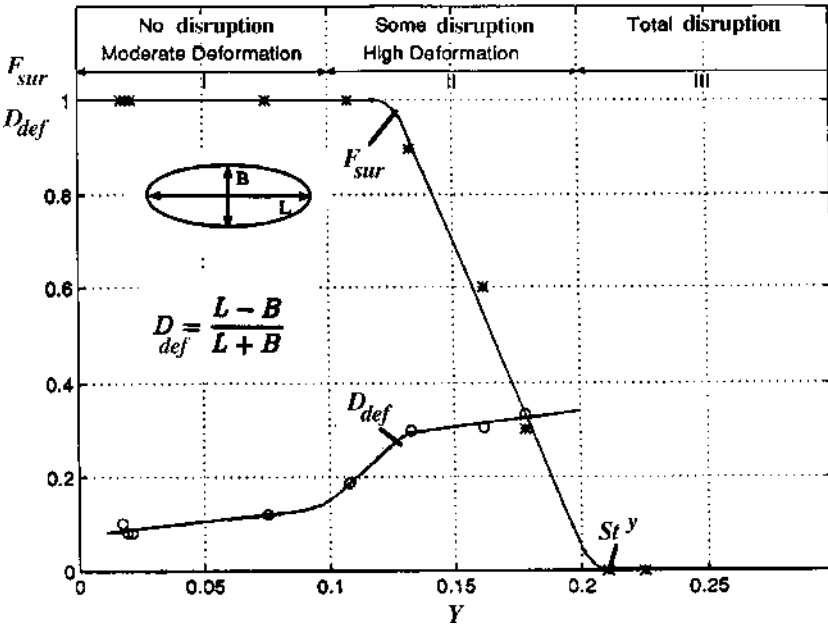
**Figure 43** Regime map of growth mechanisms, based on moisture level and deformability of formulations. (From Ref. 51.)

growth is only possible by initial wetting and nucleation, with the surrounding powder remaining ungranulated. At intermediate levels of moisture, growth occurs at a steady rate for moderate deformability, but has a delay in growth for low deformability. This delay, or induction time, is related to the time required to work moisture to the surface to promote growth. For high moisture, very rapid and potentially unstable growth occurs.

The current regime map as presented requires considerable development. Overall growth depends on the mechanics of local growth, as well as the overall mixing pattern and local/overall moisture distribution. Levels of shear are poorly understood in high-shear processes. In addition, growth by both deformation and the rigid growth model is possible. Lastly, deformability is intimately linked to both voidage and moisture. They are not a constant for a formulation, but depend on time and the growth process itself through the interplay of growth and consolidation. Nevertheless, the map provides a starting point, and is discussed in additional detail in [Chapter 18](#).

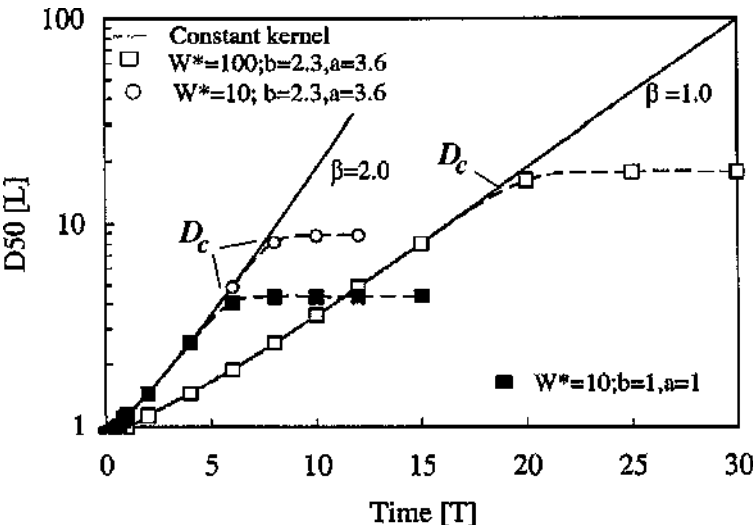
### 3.10. Determination of $St^*$

The extent of growth is controlled by some limit of granule size, either reflected by the critical Stokes number  $St^*$  or by the critical limit of granule size  $D_c$ . There are several possible methods to determine this critical limit. The first involves measuring the critical rotation speed for the survival of a series of liquid binder drops during drum granulation (3). A second refined version involves measuring the survival of granules in a couette-fluidized shear device (49,50). Both the onset of granule deformation and the complete granule rupture are determined from the dependence of granule shape and the number of surviving granules, respectively, on shear rate. The critical shear rate describing complete granule rupture defines  $St^*$ , whereas the onset of deformation and the beginning of granule breakdown defines an



**Figure 44** Determination of the onset of granule deformation and complete granule breakdown with the fluidized couette constant shear device.  $Y$  is a yield number,  $F_{sur}$  is the fraction of surviving granules, and  $D_{def}$  is the average degree of granule deformation. (From Refs. 49,50.)

additional critical value (Fig. 44). The third approach is to measure the deviation in the growth rate curve from random exponential growth (52). The deviation from random growth indicates a value of  $w^*$ , or the *critical granule diameter* at which noninertial growth ends. This value is related to  $D_c$  (Fig. 45). (See [Chapter 21](#) regarding



**Figure 45** Determination of critical granule diameter, or growth limit, from the evolution of the granule size distribution. (From Ref. 51.)

modeling for further discussion.) The last approach is through the direct measurement of the yield stress through compression experiments.

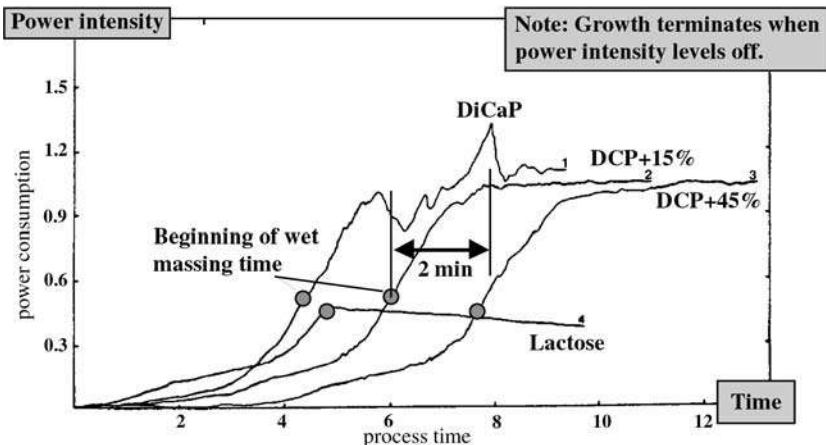
### 3.11. Example: High-Shear Mixer Growth

An important case study for high-deformability growth was conducted by Holm et al. (42) for high-shear mixer granulation. Lactose, dicalcium phosphate, and dicalcium phosphate/starch mixtures (15% and 45% starch) were granulated in a Fielder PMAT 25 VG laboratory scale mixer. Granule size, porosity, power level, temperature rise, and fines disappearance were monitored during liquid addition and wet massing phases. Impeller and chopper speeds were kept constant at 250 and 3500 rpm, respectively, with 7.0–7.5 kg starting material. Liquid flow rates and amount of binder added were varied according to the formulation.

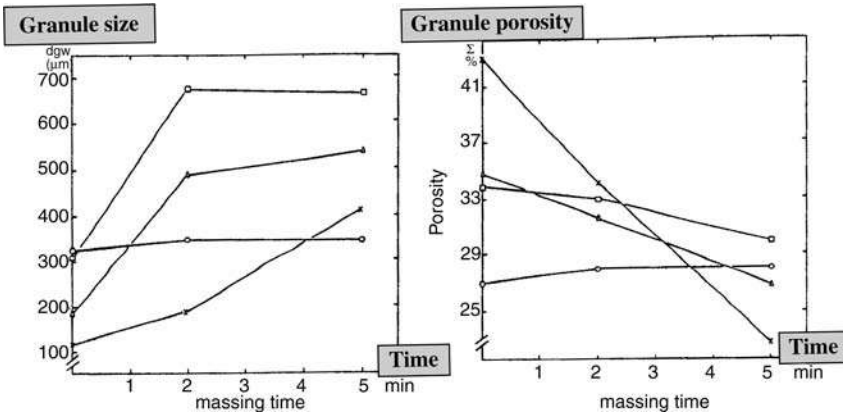
Figure 46 illustrates typical power profiles during granulation, whereas Figure 47 illustrates the resulting granule size and voidage (or porosity). Note that wet massing time (as opposed to total process time) is defined as the amount of time following the end of liquid addition, and the beginning of massing time is indicated in Figure 47.

Clear connections may be drawn between granule growth, consolidation, power consumption, and granule deformability. From comparing Figures 46 and 47 for the case of lactose, one may note that there is no further rise in power following the end of water addition (beginning of wet massing), and this corresponds to no further changes in granule size and porosity. In contrast, dicalcium phosphate continues to grow through the wet massing stage, with corresponding continual increases in granule size and porosity. Last, the starch formulations are noted to have power increase for approximately 2 min into the wet massing stage, corresponding to 2 min of growth; however, growth ceases when power consumption levels off. Therefore, power clearly tracks growth and consolidation behavior.

Further results connecting power and growth to compact deformability are provided in Holm (42). The deformability of lactose compacts, as a function of saturation and porosity, is shown to increase with moisture in a stable fashion.



**Figure 46** Power consumption for lactose, dicalcium phosphate, and dicalcium phosphate/starch mixtures (15% and 45% starch) granulated in a Fielder PMAT 25 VG. (From Ref. 42.)



**Figure 47** Granule size and porosity vs. wet massing time for lactose, dicalcium phosphate, and dicalcium phosphate/starch mixtures (15% and 45% starch) granulated in a Fielder PMAT 25 VG. (From Ref. 42.)

Therefore, growth rates and power rise do not lag behind spray addition, and growth ceases with the end of spraying. Dicalcium phosphate compacts, on the other hand, remain undeformable until a critical moisture is reached, after which they become extremely deformable and plastic. This unstable behavior is reflected by an inductive lag in growth and power after the end of spray addition, ending with unstable growth and bowl sticking as moisture is finally worked to the surface.

In closing, a comment should be made with regard to using power for control and scale-up. While it is true the power is reflective of the growth process, it is a dependent variable in many respects. Different lots of an identical formulation, e.g., may have different yield properties and deformability, and a different dependence on moisture. This may be due to minute particle property changes controlling the rate processes. Therefore, there is no unique relationship between power and growth. However, power measurements might be useful to indicate a shift in formation properties.

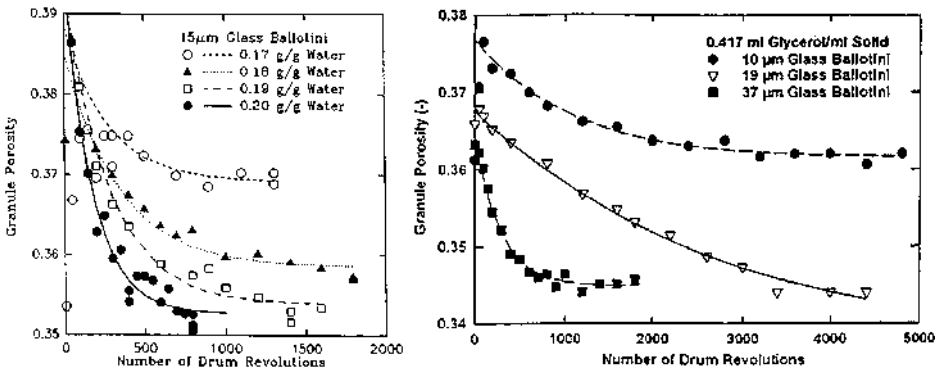
Lastly, specific power is required for scale-up, where power is normalized by the active portion of the powder bed. The impact of scale-up on mixing and distribution of power in a wet mass, however, is only partly understood at this point.

### 3.12. Granule Consolidation

Consolidation of granules determines *granule porosity* or *voidage*, and hence *granule density*. Granules may consolidate over extended times and achieve high densities if there is no simultaneous drying to stop the consolidation process. The extent and rate of consolidation are determined by the balance between the collision energy and the granule resistance to deformation. The voidage  $\varepsilon$  may be shown to depend on time as follows:

$$\frac{\varepsilon - \varepsilon_{\min}}{\varepsilon_0 - \varepsilon_{\min}} = \exp(-\beta t) \quad \text{where } \beta = fn(y, St, St_{\text{def}}) \quad (3.13)$$

Here,  $y$  is liquid loading,  $\varepsilon_0$  and  $\varepsilon_{\min}$  are the beginning and final minimum porosity, respectively (53). The effect of binder viscosity and liquid content are complex and interrelated. For low-viscosity binders, consolidation increases with liquid



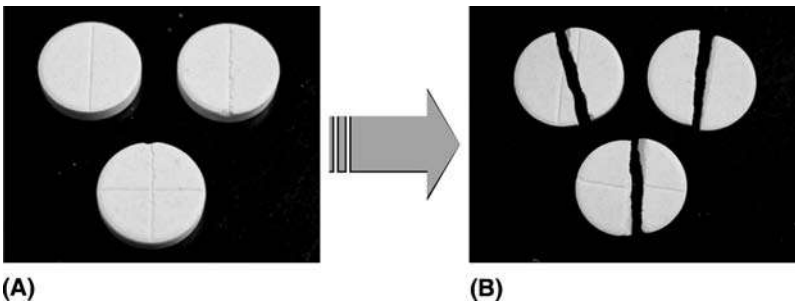
**Figure 48** Effect of binder liquid content and primary feed particle size on granule porosity for the drum granulation of glass ballotini: Decreasing granule porosity corresponds to increasing extent of granule consolidation. (From Ref. 53.)

content as shown in Figure 48 (53). This is the predominant effect for the majority of granulation systems, with liquid content related to peak bed moisture on average. Increased drop size and spray flux are also known to increase consolidation. Drying effects peak bed moisture and consolidation as well through varying both moisture level as well as binder viscosity. For very viscous binders, consolidation decreases with increasing liquid content. As a second important effect, decreasing feed particle size decreases the rate of consolidation due to the high specific surface area and low permeability of fine powders, thereby decreasing granule voidage. Last, increasing agitation intensity and process residence time increases the degree of consolidation by increasing the energy of collision and compaction. The exact combined effect of formulation properties is determined by the balance between viscous dissipation and particle frictional losses, and therefore the rate is expected to depend on the viscous and deformation Stokes numbers (53).

## 4. GRANULE STRENGTH AND BREAKAGE

### 4.1. Overview

Dry granule strength impacts three key areas of pharmaceutical processing. These include the physical attrition or breakage of granules during the granulation and drying processes, the breakage of granules in subsequent material handling steps such as conveying or feeding, and last, the deformation and breakdown of granules in compaction processes such as tableting. Modern approaches to granule strength rely on *fracture mechanics* (54). In this context, a granule is viewed as a nonuniform physical composite possessing certain macroscopic mechanical properties, such as a generally anisotropic yield stress, as well as an inherent flaw distribution. Hard materials may fail in tension, with the breaking strength being much less than the inherent tensile strength of bonds because of the existence of flaws. Flaws act to concentrate stress, as depicted in Figure 49 for commercial metamucil tablets. Here, razor scores or notches have been added to the tablets, which were subsequently broken under three-point bend loading (see later). In all cases, the tablets break at the razor score—which acts as a sharp flaw to concentrate stress—rather than at the tableted original indentation notch.



**Figure 49** Breakage of metamucil tablets by under three-point loading with razor scoring. (A) Upper left: unscored; upper right: notched scored; bottom: scored 90° to notch. (B) Breakage results. (From Ref. 4.)

Bulk breakage tests of granule strength measure both inherent bond strength and granule flaw distribution and voidage (3,4). Figure 8 presented previously illustrates granule attrition results for a variety of formulations. Granule attrition clearly increases with increasing voidage; note that this voidage is a function of granule consolidation discussed previously. Different formulations fall on different curves, due to inherently differing interparticle bond strengths. It is often important to separate the impact of bond strength vs. voidage on attrition and granule strength. Processing influences flaw distribution and granule voidage, whereas inherent bond strength is controlled by formulation properties.

The mechanism of granule breakage is a strong function of material properties of the granule itself as well as the type of loading imposed by the test conditions (55). Ranking of product breakage resistance by ad hoc tests may be test specific, and in the worst case differ from actual process conditions. Instead, material properties should be measured by standardized mechanical property tests which minimize the effect of flaws and loading conditions under well-defined geometries of internal stress, as described in the following section.

## 4.2. Mechanics of the Breakage Rate Process

Fracture toughness  $K_c$  defines the stress distribution in the body just before fracture and is given by

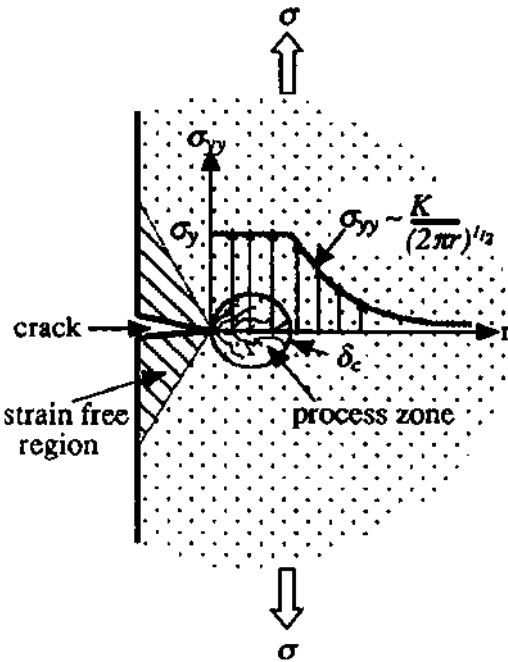
$$K_c = Y\sigma_f\sqrt{\pi c} \quad (4.1)$$

where  $\sigma_f$  is the applied fracture stress,  $c$  is the length of the crack in the body, and  $Y$  is a calibration factor introduced to account for different body geometries (Fig. 50). The elastic stress is increased dramatically as the crack tip is approached. In practice, however, the elastic stress cannot exceed the yield stress of the material, implying a region of local yielding at the crack tip. Irwin (57) proposed that this process zone size  $r_p$  be treated as an effective increase in crack length  $\delta c$ . Fracture toughness is then given by

$$K_c = Y\sigma_f\sqrt{\pi(c + \delta c)} \quad \text{with } \delta c \sim r_p \quad (4.2)$$

The process zone is a measure of the yield stress or plasticity of the material in comparison to its brittleness. Yielding within the process zone may take place either plastically or by diffuse microcracking, depending on the brittleness of the material.





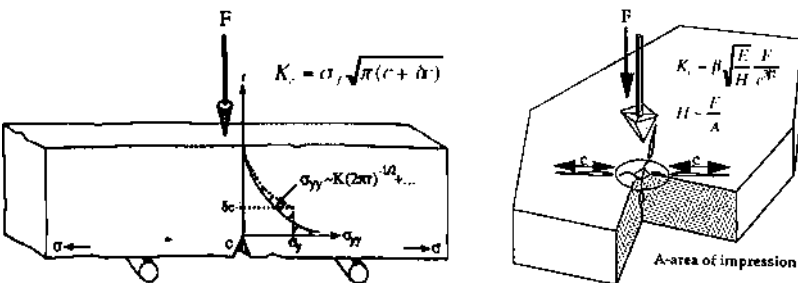
**Figure 50** Fracture of a brittle material by crack propagation. (From Ref. 56.)

For plastic yielding,  $r_p$  is also referred to as the *plastic zone size*. The *critical strain energy release rate*  $G_c$  is the energy equivalent to fracture toughness, first proposed by Griffith (58). They are related by

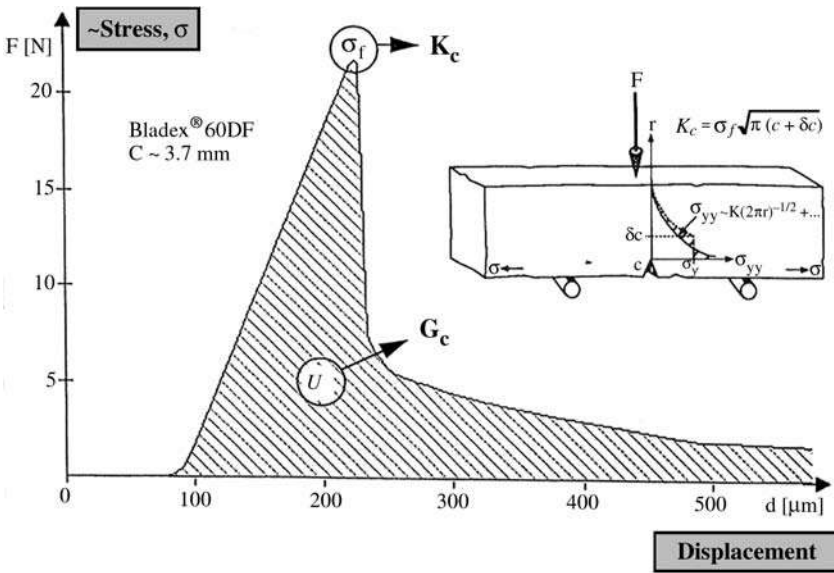
$$G_c = K_c^2/E \tag{4.3}$$

### 4.3. Fracture Measurements

In order to ascertain fracture properties in any reproducible fashion, very specific test geometry must be used since it is necessary to know the stress distribution at predefined, induced cracks of known length. Three traditional methods are: (1) the three-point bend test, (2) indentation fracture testing, and (3) Hertzian contact compression between two spheres of the material. Figures 51 and 52 illustrate a typical geometry and force response for the case of a three-point bend test. By breaking a series of dried formulation bars under three-point bend loading of varying crack



**Figure 51** Three-point bend and indentation testing for fracture properties. (From Ref. 56.)



**Figure 52** Typical force–displacement curve for three-point bend semistable failure. (From Ref. 56.)

length, fracture toughness is determined from the variance of fracture stress on crack length, as given by Eq. 4.2. (For details, see Ref. 56.)

In the case of indentation fracture, one determines hardness  $H$  from the area of the residual plastic impression, and fracture toughness from the lengths of cracks propagating from the indent as a function of indentation load  $F$  (59). Hardness is a measure of the yield strength of the material. Toughness and hardness in the case of indentation are given by

$$K_c = \beta \sqrt{\frac{E}{H}} \frac{F}{c^3} \quad \text{and} \quad H \sim \frac{F}{A} \quad (4.4)$$

Table 5 compares typical fracture properties of agglomerated materials. Fracture toughness  $K_c$  is seen to range from 0.01 to 0.06 MPa m<sup>1/2</sup>, less than that typical for polymers and ceramics, presumably due to the high agglomerate voidage. Critical strain energy release rates  $G_c$  are from 1 to 200 J/m<sup>2</sup>, typical for ceramics but less than that for polymers. Process zone sizes  $\delta c$  are seen to be large and of the order of 0.1–1 mm, values typical for polymers. Ceramics on the other hand typically have process zone sizes less than 1 μm. Critical displacements required for fracture may be estimated by the ratio  $G_c/E$ , which is an indication of the brittleness of the material. This value was of the order of 10<sup>-7</sup>–10<sup>-8</sup> mm for polymer–glass agglomerates, similar to polymers, and of the order of 10<sup>-9</sup> mm for herbicide bars, similar to ceramics. In summary, granulated materials behave not only similar to brittle ceramics, which have small critical displacements and yield strains, but also similar to ductile polymers, which have large process or plastic zone sizes.

#### 4.4. Mechanisms of Breakage

The process zone plays a large role in determining the mechanism of granule breakage (56), with mechanisms such as those previously presented in Table 1.

**Table 5** Fracture Properties of Agglomerated Materials

Material	Id	$K_c$ (MPa·m <sup>1/2</sup> )	$G_c$ (Jsolm <sup>2</sup> )	$\delta c$ ( $\mu$ m)	$E$ (MPa)	$G_c/E$ (m)
Bladex 60 <sup>®a</sup>	B60	0.070	3.0	340	567	$5.29 \times 10^{-9}$
Bladex 90 <sup>®a</sup>	B90	0.014	0.96	82.7	191	$5.00 \times 10^{-9}$
Glean <sup>®a</sup>	G	0.035	2.9	787	261	$1.10 \times 10^{-8}$
Glean <sup>®</sup> Aged <sup>a</sup>	GA	0.045	3.2	3510	465	$6.98 \times 10^{-9}$
CMC-Na (M) <sup>b</sup>	CMC	0.157	117.0	614	266	$4.39 \times 10^{-7}$
Klucel GF <sup>b</sup>	KGF	0.106	59.6	703	441	$1.35 \times 10^{-7}$
PVP 360K <sup>b</sup>	PVP	0.585	199.0	1450	1201	$1.66 \times 10^{-7}$
CMC 2% 1kN <sup>b</sup>	C2/1	0.097	16.8	1360	410	$4.10 \times 10^{-8}$
CMC 2% 5kN <sup>b</sup>	C2/5	0.087	21.1	1260	399	$5.28 \times 10^{-8}$
CMC 5% 1kN <sup>b</sup>	C5/1	0.068	15.9	231	317	$5.02 \times 10^{-8}$

<sup>a</sup>DuPont corn herbicides.

<sup>b</sup>Fifty-micrometer glass beads with polymer binder.

Source: From Ref. 56.

Agglomerates with process zones small in comparison to granule size break by a brittle fracture mechanism into smaller fragments, called *fragmentation* or *fracture*. On the other hand, for agglomerates with process zones of the order of their size, there is insufficient volume of agglomerate to concentrate enough elastic energy to propagate gross fracture during a collision. The mechanism of breakage for these materials is one of wear, erosion, or attrition brought about by diffuse microcracking. In the limit of very weak bonds, agglomerates may also shatter into small fragments or primary particles.

Each mechanism of breakage implies a different functional dependence of breakage rate on material properties. Granules generally have been found to have large process zones, which suggests granule wear as a dominant mechanism of breakage or attrition. For the case of abrasive wear of ceramics due to surface scratching by loaded indentors, Evans and Wilshaw (60) determined a volumetric wear rate  $V$  of

$$V = \frac{d_i^{1/2}}{A^{1/4} K_c^{3/4} H^{1/2}} P^{5/4} l \quad (4.5)$$

where  $d_i$  is indenter diameter,  $P$  is applied load,  $l$  is wear displacement of the indenter, and  $A$  is apparent area of contact of the indenter with the surface. Therefore, wear rate depends inversely on fracture toughness. For the case of fragmentation, Yuregir et al. (61) have shown that the fragmentation rate of organic and inorganic crystals is given by

$$V \sim \frac{H}{K_c^2} \rho u^2 a \quad (4.6)$$

where  $a$  is crystal length,  $\rho$  is crystal density, and  $u$  is impact velocity. Note that hardness plays an opposite role for fragmentation than for wear, since it acts to concentrate stress for fracture. Fragmentation rate is a stronger function of toughness as well.

Drawing on analogies with this work, the breakage rates by wear  $B_w$  and fragmentation  $B_f$  for the case of fluid-bed granulation and drying processes should be of the forms:

$$B_w = \frac{d_0^{1/2}}{K_c^{3/4} H^{1/2}} h_b^{5/4} (U - U_{mf}) \quad (4.7)$$

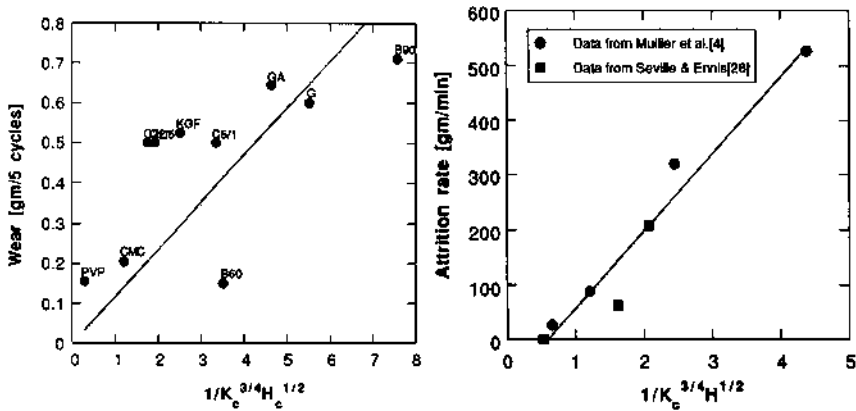
$$B_f \sim \frac{H}{K_c^2} \rho (U - U_{mf})^2 a \quad (4.8)$$

where  $d$  is granule diameter,  $d_0$  is primary particle diameter,  $(U - U_{mf})$  is fluid-bed excess gas velocity, and  $h_b$  is bed height. Figure 53 illustrates the dependence of erosion rate on material properties for bars and granules undergoing a wear mechanism of breakage, as governed by Eqs. 4.5 and 4.7.

## 5. CONTROLLING GRANULATION PROCESSES

### 5.1. An Engineering Approach to Granulation Processes

Future advances in our understanding of granulation phenomena rest heavily in engineering process design. A change in granule size or voidage is akin to a change

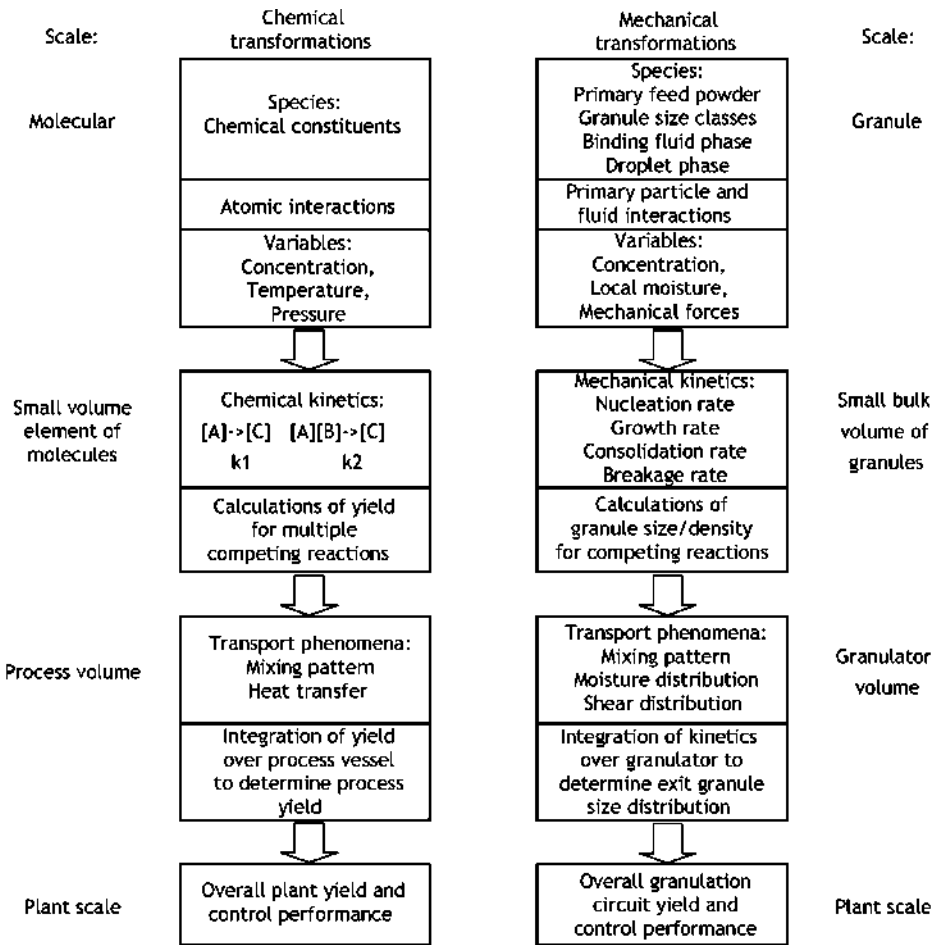


**Figure 53** Bar wear rate and fluid-bed erosion rate as a function of granule material properties.  $K_c$  is fracture toughness and  $H$  is hardness. (From Ref. 56.)

in chemical species, and so analogies exist between granulation growth kinetics and chemical kinetics and the unit operations of size enlargement and chemical reaction. These analogies are highlighted in Figure 54, where several scales of analysis must be considered for successful process design. Let us begin by considering a small-volume element of material  $A$  within a mixing process as shown in Fig. 55, and consider either the molecular or the primary particle/single-granule scale. On the *granule scale of scrutiny*, the design of chemical reactors and granulation processes differs conceptually in that the former deals with chemical transformations, whereas the latter deals primarily with *physical transformations* controlled by *mechanical processing* [Refs. 62–64]\*. Here, the rate processes of granulation are controlled by a set of key *physicochemical interactions*. These rate processes have been defined in the preceding sections, including wetting and nucleation, granule growth and consolidation, and granule attrition and breakage.

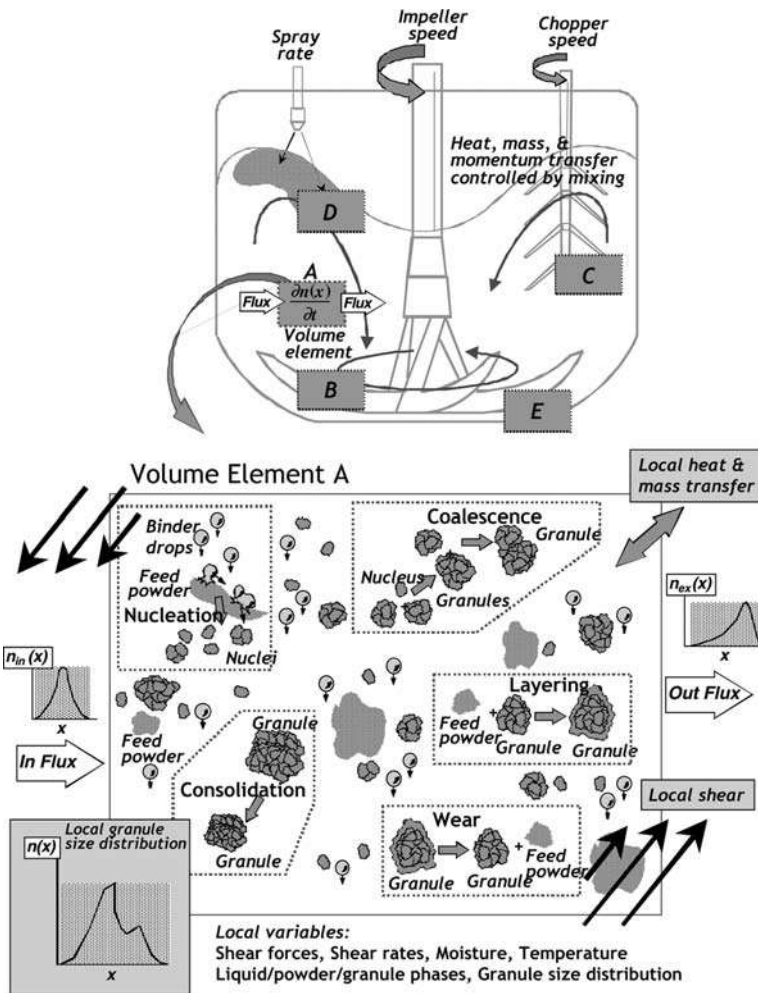
We now consider a *granule volume scale of scrutiny*, returning to our small-volume element of material  $A$  of Figure 54. Within this small volume for the case of chemical kinetics, we generally are concerned with the rate at which one or more chemical species is converted into a product. This is generally dictated by a *reaction rate constant* or *kinetic constant*, which is in turn a local function of temperature, pressure, and the concentration of feed species, as was established from previous physicochemical considerations. These local variables are in turn a function of overall heat, mass, and momentum transfer of the vessel controlled by mixing and heating/cooling. The chemical conversion occurring within a local volume element may be integrated over the entire vessel to determine the chemical yield or extent of conversion for the reactor vessel; the impact of mixing and heat transfer is generally considered in this step at the *process volume scale of scrutiny*. In the case of a granulation process, an identical mechanistic approach exists for design, where

\* This approach was pioneered by Hans Rumpf (62) and others in the early 1960s at the Universität Karlsruhe, leading to development of mechanical process technology within chemical engineering in Germany, or *Mechanische Verfahrenstechnik*. This was key to the founding of powder technology, an area in which the United States has traditionally lagged behind Europe and Japan in the areas of chemical engineering and pharmaceutical processing (61–63).



**Figure 54** Changes in state as applied to granulator kinetics and design.

chemical kinetics is replaced by granulation kinetics. The performance of a *granulator* may be described by the *extent of granulation* of a species. Let  $(x_1, x_2, \dots, x_n)$  represent a list of attributes such as average granule size, porosity, strength, and any other generic quality metric and associated variances. Alternatively,  $(x_1, x_2, \dots, x_n)$  might represent the concentrations or numbers of certain granule size or density classes, just as in the case of chemical reactors. The proper design of a chemical reactor or a granulator then relies on understanding and controlling the evolution (both *time* and *spatial*) of the feed vector  $\mathbf{X}$  to the desired product vector  $\mathbf{Y}$ . Inevitably, the reactor or granulator is contained within a larger plant scale process chain, or *manufacturing circuit*, with overall plant performance being dictated by the interaction between individual unit operations. At the *plant scale of scrutiny*, understanding interactions between unit operations can be critical to plant performance and product quality. These interactions are far more substantial with solids processing, than with liquid-gas processing. Ignoring these interactions often leads processing personnel to misdiagnose sources of poor plant performance. Tableting is often affected by segregation or poor mixing. Segregation becomes vital for preferential wetting and drug assay



**Figure 55** Granulation within a local volume element, as a subvolume of a process granulator volume, which controls local size distribution.

variation per size class. This is often effected by trace impurities in the production of drug or excipients (1,2,64).

There are several important points worth noting with regard to this approach. First, the engineering approach to the design of chemical reactors is well developed and an integral part of traditional chemical engineering education [e.g. (65)]. At present, only the most rudimentary elements of reaction kinetics have been applied to granulator design (1,2,5). Much more is expected to be gleaned from this approach over the coming decade.

Examples might include staged addition of ingredients, micronization of processes, and tailored process designs based on specific formulation properties. Second, an appreciation of this engineering approach is absolutely vital to properly scale-up granulation processes for difficult formulations. Last, this perspective provides a logical framework to approach and unravel complex processing problems, which often involve several competing phenomena. Significant progress has been made with this approach in crystallization (66) and grinding (67).

Many complexities arise when applying the results of the previous sections detailing granulation mechanisms to granulation processing. The purpose of this section is to summarize approaches to control these rate processes by placing them within the context of actual granulation systems and granulator design. Additional details of modeling and granulator design can be found in [Chapters 16](#) and [21](#).

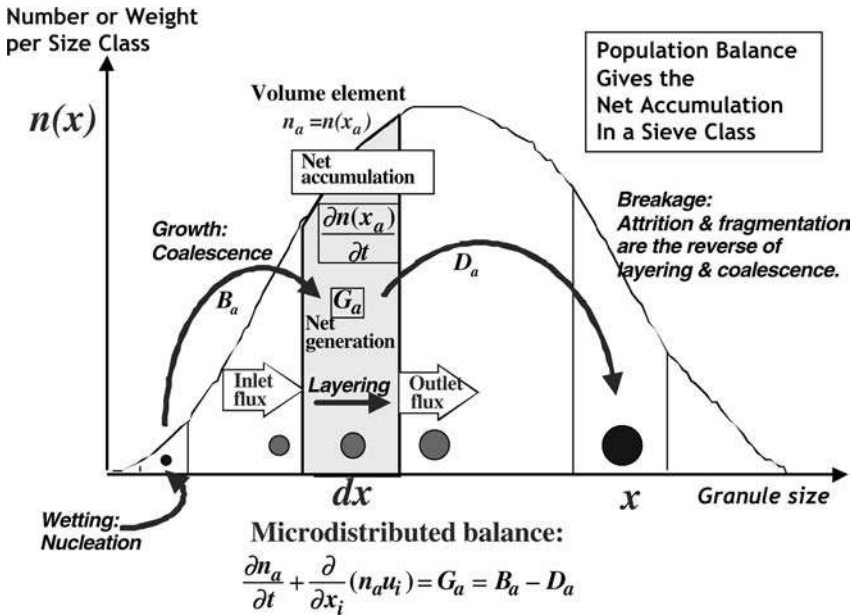
## 5.2. Scale: Granule Size and Primary Feed Particles

When considering a scale of scrutiny of the order of granules, we ask what controls the rate processes, as presented in detail in the previous sections. This key step links formulation on material variables to the process operating variables, and successful granulator design hinges on this understanding. Two key local variables of the volume element  $A$  include the *local bed moisture* and the local level of shear (both *shear rate* and *shear forces*). These variables play an analogous role of species concentration and temperature in controlling kinetics in chemical reaction. In the case of chemical reaction, increased temperature or concentration of a feed species generally increases reaction rate. For the case of granulation considered here, increases in shear rate and moisture result in increased granule/powder collisions in the presence of binding fluid, resulting in an increased frequency of successful growth events and increases in granule growth rate. Increases in shear forces also increase the granule consolidation rate, and aid growth for deformable formulations. In the limit of very high shear (e.g., due to choppers), they promote wet and dry granule breakage, or limit the growth at the least. Last, in the case of simultaneous drying, bed and gas phase moisture and temperature control heat and mass transfer and the resulting drying kinetics.

## 5.3. Scale: Granule Volume Element

Next, consider a scale of scrutiny of the level of a small bulk volume of granules, or volume element of material  $A$  in [Figure 55](#). This volume element has a particular granule size distribution controlled by the local granulation rate processes as shown pictorially in [Figure 56](#). In the wetting and nucleation rate process, droplets interact with fine powder to form initial nuclei, either directly or through mechanical breakdown of pooled overwetted regions. It is generally useful to consider the initial *powder phase* and *drop phases* as independent feed phases to the *granule phase*. In addition, the granule phase can be broken down into separate *species*, each species corresponding to a particular granule mesh size cut. Nucleation therefore results in a loss of powder and drop phases, and the *birth* of granules. Granules and initial nuclei collide within this volume element with each other and with the surrounding powder phase, resulting in both granule growth, and consolidation due to compaction forces. Granule growth by coalescence results in the discrete *birth* of granules to a new granule size class or species, as well as loss or *death* of granules from the originating size classes. On the other hand, granule growth by layering and granule consolidation result in a slow differential increase and decrease in granule size, respectively. Granule breakage by fracture and attrition (or wear) act in a similar, but opposite fashion to granule coalescence and layering, increasing the powder phase and species of smaller granules. Last, this volume element of granules interacts with the surrounding material of the bed, as granulated, powder, and drop phases flow to and from the surrounding volume elements. The rate processes of granulation and the flows or exchanges with the surrounding elements combine to





**Figure 56** The population balance over a sieve class, over specific granule size class.

control the local granule size distribution and growth rate within this small-volume element.

As illustrated in Figure 56, conducting an inventory of all granules entering and leaving a given size class  $n(x)$  by all possible granulation mechanisms leads to a microlevel population balance over the volume element given by

$$\frac{\partial n_a}{\partial t} + \frac{\partial}{\partial x_i}(n_a u_i) = G_a = B_a - D_a \tag{5.1}$$

where  $n(x, t)$  is the instantaneous granule size distribution, which varies with time and position.  $G$ ,  $B$ , and  $D$  are growth, birth, and death rates due to granule coalescence and granule fracture. The second left-hand side term reflects contributions to the distribution from layering and wear, as well as interchanges of granules from the surrounding volume elements. Nucleation rate would be considered a boundary condition of Eq. 5.1, providing a source of initial granules. Eq. 5.1 governs the local granule growth of volume element  $A$ .

Solutions to this population balance are described in greater detail in [Chapter 21](#), as well as (5,46,52). Analytical solutions are only possible in the simplest of cases. Although actual processes would require specific examination, some general comments are warranted. Beginning with nucleation, in the case of fast drop penetration into fine powders, and for small spray flux, new granules will be formed of the order of the drop size distribution, and contribute to those particular size cuts or granule species. If spray is stopped at low moisture levels, one will obtain a bimodal distribution of nuclei size superimposed on the original feed distribution. Very little growth may occur for these low moisture levels. This should not be confused with induction type growth, which is a result of low overall formulation deformability. In fact, the moisture level of the nuclei themselves will be found to be high and nearly saturated. Moisture, however, is locked up within these nuclei, surrounded by large amounts of

fine powder. Therefore, it is important not to confuse granule moisture, local moisture, and the overall average peak bed moisture of the process; they are very much not the same and are influenced by proper vessel design and operation. As moisture levels increase, and the concentration of the ungranulated powder phase decreases, the portion of the granule phase increases. As granules begin to interact more fully due to decreased surrounding powder and greater chances of achieved wet granule interaction, granule coalescence begins to occur. This in turn results in a decrease in granule number, and a rapid often exponential increase in granule size, as previously demonstrated. Coalescence generally leads to an initial widening of the granule size distribution until the granule growth limit is reached. As larger granules begin to exceed this growth limit, they can no longer coalesce with granules of similar size. Their growth rate drops substantially as they can only continue to grow by coalescence with fine granules, or by layering with any remaining fine powder. At this point, the granule size distribution generally narrows with time. Note that this provides a local description of growth, whereas the overall growth rate of the process depends greatly on mixing described next, as controlled by process design.

#### 5.4. Scale: Granulator Vessel

The local variables of moisture and shear level vary with volume element, or position in the granulator, which leads to the kinetics of nucleation, growth, consolidation, and breakage being dependent on position in the vessel, leading to a scale of scrutiny of the vessel size. As shown in [Figure 55](#), moisture levels, drop phase concentration, and nucleation will be high at position D. Significant growth will occur at position B due to increased shear forces and granule deformation, as well as increased contacting. Significant breakage can occur at position C in the vicinity of choppers. Each of these positions or volume elements will have their own specific granule size distribution.

Solids mixing (2,68) impacts overall granulation in several ways. First, it controls the local shear. Local shear rates and forces are functions of shear stress transfer through the powder bed, which is in turn a function of mixer design and bed bulk density, granule size distribution, and frictional properties. Local shear rates determine granule collisional velocities. This first area is possibly one of the least understood areas of powder processing, and requires additional research to establish the connection between operating variables and local shear rates and forces. It is also a very important scale-up consideration, as discussed in [Chapter 18](#).

Second, solids mixing controls the interchange of moisture, powder phase, and droplet phases among the local volume elements. Third, it controls the interchange of the granulated phase. Within the context of reaction kinetics (65), one generally considers extremes of mixing between well-mixed continuous and plug flow continuous, or well-mixed batch processes. The impact of mixing on reaction kinetics is well understood, and similar implications exist for the impact of mixing on granulation growth kinetics. In particular, well-mixed continuous processes would be expected to provide the widest granule size distribution (deep continuous fluidized beds are an example), whereas plug flow or well-mixed batch processes should result in narrower distributions.<sup>†</sup> In addition, it is possible to narrow the distribution further by

---

<sup>†</sup> *All else being equal*, plug flow continuous and batch well mixed processes should produce identical size distributions. It is very difficult to achieve uniform mixing in practice, with properly operating fluidized beds possibly coming the closest.

purposely segregating the bed by granule size,<sup>‡</sup> or staging the addition of ingredients, though this is a less explored area of granulator design. Last, it should be possible to predict the effects of dispersion, backmixing, and dead/stagnant zones on granule size distribution, based on previous work regarding chemical reaction kinetics.

Equation 5.1 reflects the evolution of granule size distribution for a particular volume element. When integrating this equation over the entire vessel, one is able to predict the granule size distribution vs. time and position within the granulator. Last, it is important to understand the complexities of scaling rate processes on a local level to overall growth rate of the granulator. If such considerations are not made, misleading conclusions with regard to granulation behavior may be drawn. Wide distributions in moisture and shear level, as well as granule size, and how this interacts with scale-up must be kept in mind when applying the detailed description of rate processes discussed in the previous sections. With this phenomenological description of granulation in place, we will now discuss controlling wetting, growth and consolidation, and breakage in practice, as well as the implications for two of the more common pharmaceutical granulation processes, namely fluid-bed and high-shear mixer granulation.

## 5.5. Controlling Processing in Practice

Table 6 summarizes operating variables and their impact on fluid-bed and high-shear mixer granulation. From a processing perspective, we begin with the uniformity of the process in terms of solids mixing. Approaching a uniform state of mixing as previously described will ensure equal moisture and shear levels and, therefore, uniform granulation kinetics throughout the bed; on the other hand, poor mixing will lead to differences in local kinetics. If not accounted for in design, these local differences will lead to a wider distribution in granule size distribution and properties than is necessary, and often in an unpredictable fashion—particularly with scale-up.

Increasing fluid-bed excess gas velocity ( $U - U_{mf}$ ) will increase solids flux and decrease circulation time. This can potentially narrow nuclei distribution for intermediate drop penetration times. Growth rates will be minimally affected due to increased contacting; however, the growth limit will decrease. There will be some increase in granule consolidation, and potentially a large increase in attrition. Lastly, initial drying kinetics will increase. Impeller speed in mixers will play a similar role in increasing solids flux. However, initial growth rates and granule consolidation are likely to increase substantially with an increase in impeller speed. The growth limit will decrease, partly controlled by chopper speed.

Fluidized beds can be one of the most uniform processes in terms of mixing and temperature. Powder frictional forces are overcome as drag forces of the fluidizing gas support bed weight, and gas bubbles promote rapid and intensive mixing. In the case of mixers, impeller speed in comparison to bed mass promotes mixing, with choppers eliminating any gross maldistribution of moisture and over growth.

With regard to bed weight, forces in fluid beds, and therefore consolidation and granule density, generally scale with bed height. As a gross rule of thumb, ideally, the power input per unit mass should be maintained with mixer scale-up, related in part

---

<sup>‡</sup> Pan granulation is a specific process promoting segregation by granule size. Since large granules interact less with smaller granule size classes, layering can be promoted at the expense of coalescence, thereby narrowing the granule size distribution.

**Table 6** Impact of Key Operating Variables in Pharmaceutical Granulation

Effect of changing key process variables	Fluidized beds (including coating and drying)	High-shear mixers
Increasing solids mixing, solids flux, and bed agitation	<p>Increasing excess gas velocity:            Improves bed uniformity            Increases solids flux            Decreases solids circulation time            Potentially improves nucleation            No effect on noninertial growth rate            Lowers growth limit            Some increase in granule consolidation            Increases granule attrition            Increases initial drying kinetics            Distributor design: Impacts attrition and defluidization</p>	<p>Increasing impeller/chopper speed:            Improves bed uniformity            Increases solids flux            Decreases solids circulation time            Potentially improves nucleation            Increases growth rate            Lowers growth limit            Increase granule consolidation            Impeller/chopper design:            Improvements needed to improve shear transmission for cohesive powders</p>
Increasing bed weight	<p>Increasing bed height:            Increases granule consolidation, density and strength</p>	<p>Increasing bed weight:            Generally lowers power per unit mass in most mixers, lowering growth rate            Also increases nonuniformity of cohesive powders, and lowers solids flux and increases circulation time</p>
Increasing bed moisture (Note: Increasing bed temperature normally acts to lower bed moisture due to drying)	<p>Increases rates of nucleation, growth, and consolidation giving larger, denser granules with generally a wider distribution</p>	<p>Increases rates of nucleation, growth, and consolidation giving larger, denser granules with generally a wider distribution</p>
Increasing residence time	<p>Granule size and distribution generally increase until limit            Distribution can narrow if growth limit is reached            Increases chances of defluidization</p>	<p>Granule size and distribution generally increase until limit            Distribution can narrow if growth limit is reached            Increases chances of overmassing and bowl buildup</p>

*(Continued)*

**Table 6** Impact of Key Operating Variables in Pharmaceutical Granulation (*Continued*)

Effect of changing key process variables	Fluidized beds (including coating and drying)	High-shear mixers
Increasing spray distribution:	Largely affected	Less affected
Lower liquid feed or spray rate	Wettable powders and short penetration times generally required	Poorly wetting powders and longer penetration time possible
Lower drop size	For fast penetration:	For fast penetration:
Increase number of nozzles	Decreases growth rate	Decreases growth rate
Increase air pressure (two-fluid nozzles)	Decreases spread of size distribution	Decreases spread of size distribution
Increase solids mixing (above)	Decreases granule density and strength	Decreases granule density and strength
	For slow penetration: Poor process choice Defluidization likely	For slow penetration: Mechanical dispersion of fluid
		Little effect of distribution; however, slowing rate of addition minimizes lag in growth rate
Increasing feed particle size (Can be controlled by milling)	Requires increase in excess gas velocity Minimal effect of growth rate Increase in granule consolidation and density	Increase in growth rate Increase in granule consolidation and density

to swept volume per unit time, as studied by Kristensen and coworkers. However, cohesive powders can be ineffective in transmitting stress, meaning that only a portion of the bed may be activated with shear at large scale, whereas the entire bowl may be in motion at a laboratory scale. Therefore, mixing may not be as uniform in mixers as it is in fluidized beds. Equipment design also plays a large role, including air distributor and impeller/chopper design for fluid bed and mixers, respectively.

Increasing bed moisture and residence time increase overall growth and consolidation. However, it also increases the chances of bed defluidization or overmassing/bowl buildup in fluid beds and mixers, respectively. Increasing bed temperature normally acts to lower bed moisture due to drying. This acts to raise effective binder viscosity and lower granule consolidation and density, as well as initial growth rates for the case of high-shear mixers. This effect of temperature and drying generally offsets the inverse relationship between viscosity and temperature.

Spray distribution generally has a large effect in fluid beds, but in many cases, a small effect in mixers. In fact, fluid-bed granulation is only practical for wettable powders with short drop penetration time, since otherwise defluidization of the bed would be promoted to local pooling of fluid. Mechanical dispersion counteracts this in mixers. There may be benefit, however, to slowing spray rates in mixers for formulation with inductive growth behavior, as this will minimize the lag between spray and growth, as discussed previously.

In summary, for the case of fluid-bed granulation, growth rate is largely controlled by spray rate and distribution and consolidation rate by bed height and peak bed moisture. For the case of mixers, growth and consolidation are controlled by impeller and chopper speed. From a formulation perspective, we now turn to each rate process.

## 5.6. Controlling Wetting in Practice

Table 7 summarizes typical changes in material and operating variables which improve wetting uniformity. Also listed are appropriate routes to achieve these changes in a given variable through changes in either the formulation or the processing. Improved wetting uniformity generally implies a tighter granule size distribution and improved product quality. Eqs. 2.5, 2.9, and 2.13 provide basic trends of the impact of material variables on wetting dynamics and extent, as described by the dimensionless spray flux and drop penetration time.

Since drying occurs simultaneously with wetting, the effect of drying can substantially modify the expected impact of a given process variable and this should not be overlooked. In addition, simultaneous drying often implies that the dynamics of wetting are far more important than the extent.

Adhesion tension should be maximized to increase the rate and extent of both binder spreading and binder penetration. Maximizing adhesion tension is achieved by minimizing contact angle and maximizing surface tension of the binding solution. These two aspects work against one another as surfactant is added to a binding fluid, and in general, there is an optimum surfactant concentration for the formulation (27). Surfactant type influences adsorption and desorption kinetics at the three-phase contact line. Inappropriate surfactants can lead to Marangoni interfacial stresses which slow the dynamics of wetting (25). Additional variables which influence adhesion tension include (1) impurity profile and particle habit/morphology typically controlled in the particle formation stage such as crystallization, (2) temperature of granulation, and (3) technique of grinding, which is an additional source of impurity as well.

Decreases in binder viscosity enhance the rate of both binder spreading and binder penetration. The prime control over the viscosity of the binding solution is through binder concentration. Therefore, liquid loading and drying conditions strongly influence binder viscosity. For processes without simultaneous drying, binder viscosity generally decreases with increasing temperature. For processes with simultaneous drying, however, the dominant observed effect is that lowering temperature lowers binder viscosity and enhances wetting due to decreased rates of drying and increased liquid loading.

Changes in particle size distribution affect the pore distribution of the powder. Large pores between particles enhance the rate of binder penetration, whereas they decrease the final extent. In addition, the particle size distribution affects the ability of the particles to pack within the drop as well as the final degree of saturation (69).

The drop distribution and spray rate of binder fluid have a major influence on wetting. Generally, finer drops will enhance wetting as well as the distribution of binding fluid. The more important question, however, is how large may the drops be or how high a spray rate is possible. The answer depends on the wetting propensity of the feed. If the liquid loading for a given spray rate exceeds the ability of the fluid to penetrate and spread on the powder, maldistribution in binding fluid will develop in the bed. This maldistribution increases with increasing spray rate, increasing drop size, and decreasing spray area (due to, e.g., bringing the nozzle closer to the bed or switching to fewer nozzles). The maldistribution will lead to large granules on the one hand and fine ungranulated powder on the other. In general, the width of the granule size distribution will

**Table 7** Controlling Wetting in Granulation Processes

Typical changes in material or operating variables which improve wetting uniformity	Appropriate routes to alter variable through formulation changes	Appropriate routes to alter variable through process changes
Increase adhesion tension Maximize surface tension Minimize contact angle	Alter surfactant concentration or type to maximize adhesion tension and minimize Marangoni effects Precoat powder with wettable monolayers, e.g., coatings or steam	Control impurity levels in particle formation Alter crystal habit in particle formation Minimize surface roughness in milling
Decrease binder viscosity	Lower binder concentration Change binder Decrease any diluents and polymers which act as thickeners	Raise temperature for processes without simultaneous drying Lower temperature for processes with simultaneous drying since binder concentration will decrease due to increased liquid loading
Increase pore size to increase rate of fluid penetration Decrease pore size to increase extent of fluid penetration	Modify particle size distribution of feed ingredients	Alter milling, classification, or formation conditions of feed if appropriate to modify particle size distribution
Improve spray distribution (Related to dimensionless spray flux, given by ratio of spray to solid fluxes)	Improve atomization by lowering binder fluid viscosity	Increase wetted area of the bed per unit mass per unit time by increasing the number of spray nozzles, lowering spray rate, increasing air pressure or flow rate of two fluid nozzles
Increase solids mixing (Related to dimensionless spray flux)	Improve powder flowability of feed	Increase agitation intensity (e.g., impeller speed, fluidization gas velocity, or rotation speed)
Minimize moisture buildup and losses	Avoid formulations which exhibit adhesive characteristics with respect to process walls	Maintain spray nozzles to avoid caking and nozzle drip; avoid spray entrainment in process air streams, and spraying process walls

Source: Refs. 1,2,5.

**Table 8** Controlling Growth and Consolidation in Granulation Processes

Typical changes in material or operating variables which maximize growth and consolidation	Appropriate routes to alter variable through formulation changes	Appropriate routes to alter variable through process changes
Rate of growth (low deformability): Increase rate of nuclei formation Increase collision frequency  Increase residence time	Improve wetting properties (see Wetting subsection); Increase binder distribution	Increase spray rate and number of drops Increase mixer impeller or drum rotation speed or fluid-bed gas velocity Increase batch time or lower feed rate
Rate of growth (high deformability): Decrease binder viscosity  Increase agitation intensity  Increase particle density Increase rate of nuclei formation, collision frequency and residence time, as above for low-deformability systems	Decrease binder concentration or change binder; decrease any diluents and polymers which act as thickeners	Decrease operating temperature for systems with simultaneous drying; otherwise increase temperature  Increase mixer impeller or drum rotation speed or fluid-bed gas velocity



## Extent of growth:

Increase binder viscosity

Decrease agitation intensity

Decrease particle density

Increase liquid loading

Increase binder concentration, change binder, or add diluents and polymers as thickeners

Increase operating temperature for systems with simultaneous drying; otherwise decrease temperature

Decrease mixer impeller or drum rotation speed or fluid-bed gas velocity

Extent observed to increase linearly with moisture

## Rate of consolidation:

Decrease binder viscosity

Increase agitation intensity

Increase particle density

Increase particle size

As above for high deformability systems

Particle size and friction strongly interact with binder viscosity to control consolidation; feed particle size may be increased and fine tail of distribution removed

As above for high deformability systems; in addition, increase compaction forces by increasing bed weight, or altering mixer impeller or fluid-bed distributor plate design

Size is controlled in milling and particle formation

---

*Source:* From Refs. 1,2,5.

**Table 9** Controlling Breakage in Granulation Processes

Typical changes in material or operating variables which minimize breakage	Appropriate routes to alter variable through formulation changes	Appropriate routes to alter variable through process changes
Increase fracture toughness Maximize overall bond strength Minimize agglomerate voidage	Increase binder concentration or change binder; bond strength strongly influenced by formulation and compatibility of binder with primary particles	Decrease binder viscosity to increase agglomerate consolidation by altering process temperatures (usually decrease for systems with simultaneous drying) Increase bed agitation intensity (e.g., increase impeller speed, increase bed height) to increase agglomerate consolidation Increase granulation residence time to increase agglomerate consolidation, but minimize drying time
Increase hardness to reduce wear Minimize binder plasticity Minimize agglomerate voidage	Increase binder concentration or change binder; binder plasticity strongly influenced by binder type	See above effects which decrease agglomerate voidage
Decrease hardness to reduce fragmentation Maximize binder plasticity Maximize agglomerate voidage	Change binder; binder plasticity strongly influenced by binder type	Reverse the above effects to increase agglomerate voidage Apply coating to alter surface hardness

Decrease load to reduce wear

Lower formulation density

Decrease bed agitation and compaction forces (e.g., mixer impeller speed, fluid-bed height, bed weight, fluid-bed excess gas velocity)

Decrease contact displacement to reduce wear

Decrease contacting by lowering mixing and collision frequency (e.g., mixer impeller speed, fluid-bed excess gas velocity, drum rotation speed)

Decrease impact velocity to reduce fragmentation

Lower formulation density

Decrease bed agitation intensity (e.g., mixer impeller speed, fluid-bed excess gas velocity, drum rotation speed)  
Also strongly influenced by distributor plate design in fluid beds, or impeller and chopper design in mixers

---

*Source:* From Refs. 1,2,5.

increase and generally the average size will decrease. Improved spray distribution can be aided by increases in agitation intensity (e.g., mixer impeller or chopper speed, drum rotation rate, or fluidization gas velocity) and by minimizing moisture losses due to spray entrainment, dripping nozzles, or powder caking on process walls.

## 5.7. Controlling Growth and Consolidation in Practice

Table 8 summarizes typical changes in material and operating variables which maximize granule growth and consolidation. Also listed are appropriate routes to achieve these changes in a given variable through changes in either the formulation or the processing. Growth and consolidation of granules are strongly influenced by rigid (especially fluid beds) and deformability (especially mixers) Stokes numbers. Increasing  $St$  increases energy with respect to dissipation during deformation of granules. Therefore, the rate of growth for deformable systems (e.g., deformable formulation or high-shear mixing) and the rate of consolidation of granules generally increases with increasing  $St$ .  $St$  may be increased by decreasing binder viscosity or increasing agitation intensity. Changes in binder viscosity may be accomplished by formulation changes (e.g., the type or concentration of binder) or by operating temperature changes. In addition, simultaneous drying strongly influences the effective binder concentration and viscosity. The *maximum* extent of growth increases with decreasing  $St$  and increased liquid loading, as reflected by Eqs. 3.11. Increasing particle size also increases the rate of consolidation, and this can be modified by upstream milling or crystallization conditions.

## 5.8. Controlling Breakage in Practice

Table 9 summarizes typical changes in material and operating variables necessary to minimize breakage. Also listed are appropriate routes to achieve these changes in a given variable through changes in either the formulation or the processing. Both fracture toughness and hardness are strongly influenced by the compatibility of the binder with the primary particles, as well as the elastic/plastic properties of the binder. In addition, hardness and toughness increase with decreasing voidage and are influenced by previous consolidation of the granules. While the direct effect of increasing gas velocity and bed height is to increase breakage of dried granules, increases in these variables may also act to increase consolidation of wet granules, lower voidage, and therefore lower the final breakage rate. Granule structure also influences breakage rate, e.g., a layered structure is less prone to breakage than a raspberry-shaped agglomerate. However, it may be impossible to compensate for extremely low toughness by changes in structure. Measurements of fracture properties help define expected breakage rates for a product and aid product development of formulations.

## ACKNOWLEDGMENTS

This chapter is the result of many collaborative efforts. Support for initial granulation research was provided by the International Fine Particle Research Institute, G. Tardos and R. Pfeffer of The City College of the City University of New York, and E.I Du Pont de Nemours & Company. Based on earlier versions with A. Maraglou of Du Pont, the material was developed into a training course by E&G Associates, and later refined in collaboration with J. Litster of the Univer-

sity of Queensland. All of these collaborations, as well as discussions with P. Mort, A. Adetayo, J. Seville, S. Pratsinis, S. Iveson, K. Hapgood, J. Green, P. C. Kapur, T. Schaefer, and H. Kristensen are acknowledged with great appreciation. Last, to the countless course participants over the last decade goes a special thank you.

## REFERENCES

1. Ennis BJ, Litster J. Size enlargement and size reduction. In: Green D, Perry R, eds. Perry's Chemical Engineers' Handbook. 7th ed. New York: McGraw-Hill, 1994: Section 21.
2. Ennis BJ, ed. Solids-solids processing. In: Green D, Perry R, eds. Perry's Chemical Engineers' Handbook. 8th ed. New York: McGraw Hill, 2005:Section 19.
3. Ennis BJ. On the Mechanics of Granulation. Ph.D. thesis, The City College of the City University of New York, University Microfilms International, 1990.
4. Ennis BJ. Design & Optimization of Granulation Processes for Enhanced Product Performance. Nashville, TN: E&G Associates, 1990–2004.
5. Litster J, Ennis BJ. The Science & Engineering of Granulation Processes. Dordrecht, The Netherlands: Kluwer Academic, 2004.
6. Masters K. Spray Drying Handbook 3rd ed. New York: Wiley & Sons, 2002.
7. Masters K. Spray Drying in Practice. ApS, Denmark: SprayDryConsult International, 1979.
8. Ennis BJ, Mehos G, Wu S, Patel P. Characterizing the impact of flow aids on flowability of pharmaceutical excipients by automated shear cell. AAPS Annual Meeting, Baltimore: MD, 2004.
9. Brown RL, Richards. Principles of Powder Mechanics. Oxford: Pergamon Press, 1970.
10. Stanley-Wood N. Enlargement and Compaction of Particulate Solids. London: Butterworth & Co. Ltd, 1983.
11. Ennis BJ. Powder Technol 1996; 88:203.
12. Turton R, Tardos G, Ennis BJ. Fluidized Bed Coating and Granulation. In: Yang WC, Fluidization, Solids Handling & Processing, New Jersey: Noyes Publications, Westword, 1999.
13. Pietsch W. Size Enlargement by Agglomeration. Chichester: John Wiley & Sons Ltd., 1992.
14. Sastry K, Fuerstenau D. In: Sastry, ed. Agglomeration '77. New York: AIME, 1977:381.
15. Kapur PC. Adv Chem Eng 1978; 10:55.
16. Kapur PC. Chem Eng Sci 1971; 26:1093.
17. Kapur PC, Fuerstenau DW. Ind Eng Chem Eng (Proc Des Dec) 1966; 5:5.
18. Kapur PC. Chem Eng Sci 1971; 26:1863.
19. Kapur PC. Chem Eng Sci 1971; 26:1093.
20. Rumpf H. The strength of granules and agglomerates. In: Knepper WA, ed. Agglomeration. New York: Interscience, 1962: 379–414.
21. Rumpf H. Particle adhesion. In: Sastry KVS, ed. Agglomeration '77, New York: AIME, 1997: 97–129.
22. Augsburg L, Vuppala M. Chap. 2, In: Parikh D, Handbook of Pharmaceutical Granulation Technology. 1<sup>st</sup> ed., New York: Marcel-Dekker, 1999.
23. Parfitt G, ed. Dispersion of Powders in Liquids. Amsterdam: Elsevier Applied Science Publishers Ltd., 1986.
24. Hapgood K. Nucleation and Binder Dispersion in Wet Granulation, Ph.D. Thesis, University of Queensland, 2000.
25. Pan R, Green J, Ennis BJ, Maderelli C. Dynamic Properties of Interfaces & Association Structure. New York: American Oil Chemical Society Press, 1995.
26. Zisman WA. Contact angle, wettability, and adhesion. Adv Chem Ser 1964; 43:1.
27. Ayala R. Ph.D. Thesis, Chem. Eng., Carnegie Mellon University, 1985.

28. Shaw R. Introduction to Colloid and Surface Chemistry. London: Butterworths & Co. Ltd, 1983.
29. Fuerstaneau DW, Diao J, Williams MC. *Coll Surf* 1991; 60:127.
30. Vargha-Butler EI. In: Botsaris GD, Glazman YM, eds. *Interfacial Phenomena in Coal Technology*. Chap. 2. New York: Marcel-Dekker, 1989.
31. Aulton ME, Banks M. *Proceedings of Powder Technology in Pharmacy Conference: Powder Advisory Centre, Basel, Switzerland, 1979*.
32. Aulton ME et al. *J Pharm Pharmacol* 1977; 29:59.
33. Litster JD, Hapgood KP, Kamineni SK, Hsu T, Sims A, Roberts M, Michaels J. *Powder Technol* 2001; 124:272.
34. Ouchiya N, Tanaka T. I and EC. *Proc Des Dev* 1982; 21:29.
35. Johnson KL. *Contact Mechanics*. Cambridge University Press, 1985.
36. Ritala M, Holm P, Schaefer T, Kristensen HG. *Drug Dev Ind Pharm* 1988; 14(8):1041.
37. Holm P, Schaefer T, Kristensen HG. *Powder Technol* 1985; 43:213.
38. Adams M, Thornton C, Lian G. Agglomeration & size enlargement. In: Ennis BJ, ed. *Proceedings of the First International Particle Technology Forum*. Vol. 1. Denver, CO: AIChE, 1994:155–286.
39. Ennis BJ, Li J, Tardos G, Pfeffer R. *Chem Eng Sci* 1990; 45(10):3071.
40. Mazzone D, Tardos G, Pfeffer R. *J Coll Interface Sci* 1986; 113:544.
41. Iveson SM, Breathe JA, Page NW. *Powder Technol* 2002; 127:149.
42. Holm P, Schaefer T, Kristensen HG. Part V and VI. *Powder Technol* 1985; 43:213–233.
43. Ennis B, Tardos G, Pfeffer R. *Powder Technol* 1991; 65:257.
44. Liu LX, Litster JD, Iveson SM, Ennis BJ. *AIChE J* 2000; 46(3):529.
45. Bird RB, Armstrong R, Hassager O. *Dynamics of Polymeric Liquids*. Vol. 1. New York: John Wiley & Sons, Inc., 1977.
46. Adetayo AA, Lister JD, Pratsinis SE, Ennis BJ. *Powder Technol* 1995; 82:37.
47. Schaefer T, Holm P, Kristensen HG. *Drug Dev Ind Pharm* 1990; 16(8):1249.
48. Schaefer T, Holm P, Kristensen HG. *Pharm Ind* 1990; 52(9):1147.
49. Tardos G, Khan MI. *AIChE Annual Meeting, Miami, 1995*.
50. Tardos GI, Khan MI, Mort PR. *Powder Technol* 1997; 94:245.
51. Iveson SM, Wauters PAL, Forrest S, Litster JD, Meester GMH, Scarlett B, Ennis B. *Powder Technol* 2001; 117:83.
52. Adetayo AA, Ennis B. *AIChE J* 1997; 43(4):927.
53. Iveson SM, Litster JD, Ennis BJ. *Powder Technol* 1996; 88:15.
54. Lawn B. *Fracture of Brittle Solids*. 2nd ed. Cambridge University Press, 1975.
55. Benbow JJ, Bridgwater J. *Powder Technol* 1987; 49:97.
56. Ennis BJ, Sunshine G. *Tribology International* 1993; 26:319.
57. Irwin J *Appl Mech* 1957; 24:361.
58. Griffith AA. *Philos Trans T Soc* 1920; A221:163.
59. Johnsson L, Ennis BJ. In: Ennis BJ, ed. *Proceedings of the First International Particle Technology Forum*. Vol. 2. Denver, CO: AIChE, 1994:178.
60. Evans AG, Wilshaw TR. *Acta Metall* 1976; 24:939.
61. Yuregir KR, Ghadiri M, Clift R. *Chem Eng Sci* 1987; 42:843.
62. Rumpf H. *Translated FA Bulletin. Particle Technology*. New York: Chapman & Hall, 1990.
63. Ennis BJ, Green J, Davies R. *The US Legacy of Neglect*. *Chem Eng Prog* 1994; 90(4):32.
64. Ennis BJ, Green J. *Visualizing Pharmaceutical Manufacturing as an Integrated Series of Particle Processes*. New York: Interphex, 1995.
65. Levenspiel O. *Chemical Reaction Engineering*. 2nd ed. New York: Wiley, 1972.
66. Randolph AD, Larson MA. *Theory of Particulate Processes*. 2<sup>nd</sup> ed. San Diego: Academic Press Inc., 1991.
67. Prasher CL. *Crushing and Grinding Process Handbook*. New York: Wiley, 1987.
68. Weinekötter R, Gericke H. *Mixing of Solids*. Dordrecht, The Netherlands: Kluwer Academic, 2000.
69. Waldie B. *Chem Eng Sci* 1991; 46:2781.

# 3

## Drug Substance and Excipient Characterization

L. W. Chan and P. W. S. Heng

*National University of Singapore, Singapore*

### 1. INTRODUCTION

Characterization of drug substances and excipients is a very important step at the preformulation phase of product development. Although testing will involve additional time and cost, failure to carry out the appropriate characterization tests can be even more costly to manufacturers if the product made is not within specifications. Preformulation characterization of raw materials creates a body of information which is very useful in the development of products. The lack of such information leaves the formulator with little leeway for remediation action when a problem arises from the production process or from the quality of the finished product. It is important to eliminate the possible influences of the raw material characteristics before venturing into investigation of processing variables. The knowledge derived from the characterization of raw materials can also serve to enable better specifications to be drawn up for procuring materials with the aim of either reducing cost or improving product quality. In addition, a review of material characterization results can provide an excellent database for the assessment of suppliers who can provide materials of consistent quality.

Materials from reputable companies may be supplied with detailed specifications and their methods of determination may be obtained, if requested. The information on specifications such as purity or content is very often available. Nevertheless, it is prudent to confirm such information. The information provided by different suppliers may vary. The type of tests carried out or the techniques used for the characterization of a particular physical property, for example, the particle size distribution, may be different. Comparison of materials from different suppliers can therefore be difficult. Sometimes, the analytical result supplied by the manufacturer is given as falling within a certain range and this gives virtually no information about batch to batch variation of the material.

It is therefore important to have a system of in-house characterization of raw materials alongside the stability and functional tests for the finished product. Whenever possible, tests carried out should yield quantitative results rather than a pass/fail or present/absent assessment. Retrospective studies of the finished product test

results together with well-documented production process validation and characterization tests of raw materials can provide directions for refinement of the production process and improve the specifications for raw materials.

The method of material characterization varies considerably as it depends on the nature and form of material used as well as the process involved in the conversion of the raw materials to the finished products. The desirable characterization test for each material depends on the material itself and the likely use or influence of a particular material property on the process or product. For instance, detailed information of the particle size distribution of a drug material may be less important when the end product is a solution, more important when the material is to be granulated and very critical when preparing an inhalant. As unnecessary testing can be translated into additional cost, careful consideration of the type and number of tests to be carried out on the raw materials should be weighed against the usefulness of tests to give information on the identity and quality of raw materials, their effects during processing and manufacturing and the functionality and esthetics of the finished products.

The task of building up a body of information on materials is indeed difficult given the wide spectrum of drugs and excipients used in pharmaceutical granulation. Many compendial tests are concerned with the chemical aspects of testing and rarely address the physical characterization of excipient materials. The physical aspects of raw materials are more likely than their chemical properties to exert a greater influence on the granulation process as well as the quality and functionality of the finished products. The ability to define excipients using the correct functionality tests would undoubtedly benefit the formulator greatly as better-defined excipients could help to eliminate many processing problems. It is obvious that some material characterization tests such as determination of identity and purity are important but discussion on them is not included as they are better dealt separately.

## **2. PARTICLE SHAPE, SIZE, AND SURFACE AREA**

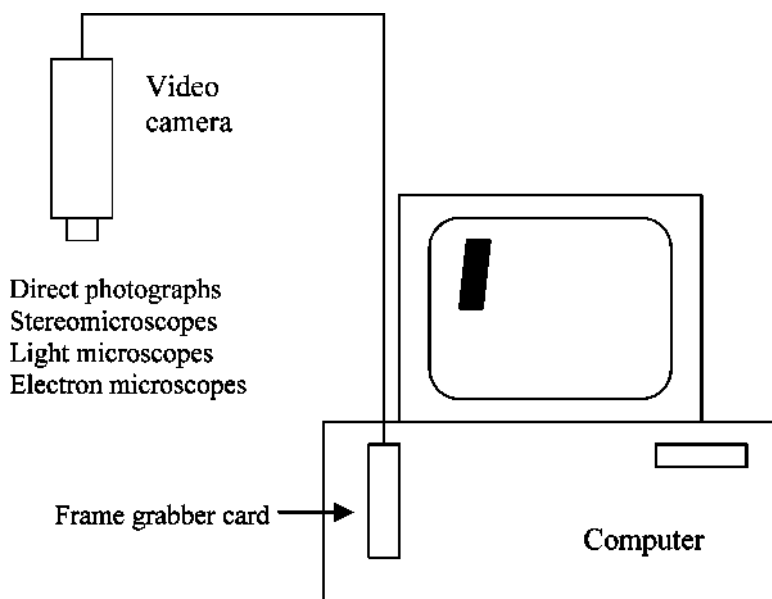
### **2.1. Particle Shape**

Particle shape is an important parameter which can have a significant effect on the bulk properties of a powder. It is well known that spherical particles flow better, pack better, and have a lower surface to volume ratio. Despite the well-recognized importance of particle shape, the method of shape determination has not been clearly defined owing to the complexity and variability of the three-dimensional particles. In general, shape measurement methods are only able to define accurately the shape if the shape of constituent particles can be correctly predicted based on a two-dimensional model.

Shape of particles may be assessed descriptively by terms such as spherical, elongated, acicular, angular, or a host of other terms. Although these are descriptive terms, if accurately used, they can convey a general idea of the particle shape. However, they reveal little about the degree to which the particles take upon a particular shape. Without a comparable quantitative measure, it may be difficult to assess the effects of particle shape on a process or product.

From the linear dimensional description of breadth, length, and height, some shape data can be derived. Breadth is usually defined as the minimum distance between two parallel lines bracketing the particle while length is the maximum distance between two parallel lines enclosing the particle and is perpendicular to





**Figure 1** Image analysis system.

the breadth. The height is the thickness of the particle resting in its most stable orientation. The measurement of height is generally difficult for small particles as they are usually viewed through a microscope.

Direct microscopic measurement of particle dimensions is very tedious. The particle dimension is obtained using a linear eyepiece graticule. A camera lucida attachment may be used to trace out the outline of particles onto a paper. The perimeter of particle tracing may be obtained by using either a string or a planimeter. Projected area can be obtained by using paper with grids or by cutting out tracing of particle and weighing. By determining the area per unit weight of the paper, weight of tracing may be converted into an area measurement. The popularity of this laborious manual mode of dimensional measurement has declined significantly with the introduction of image analyzers. When a video camera is attached to a microscope, the image obtained on a high-resolution monitor may be digitized and analyzed using a computer as shown in Figure 1. Information on the breadth, length, perimeter, and area of particles can be determined very rapidly. The degree of accuracy of such measurements depends on the clarity of image available and the separation of particles from one another.

There are a large number of transformation models which can be used to analyze the image dimensional parameters in the determination of particle shape. Some methods require additional information of particle surface area, volume or thickness to give better estimates of shape but for most purposes, a simple approach is often preferred. The common treatment of data, namely, breadth, length, perimeter, and area to reflect the particle shape (1,2) is given as follows:

$$\text{Aspect or elongation ratio} = \frac{\text{Length}}{\text{Breadth}} \quad (2.1)$$

$$\text{Bulkiness factor} = \frac{\text{Area}}{(\text{Length} + \text{Breadth})} \quad (2.2)$$

$$\text{Formfactor} = \frac{4\pi(\text{Area})}{(\text{Perimeter})^2} \quad (2.3)$$

The elongation ratio is very useful for assessing deviation from a spherical shape to an elongated form. The formfactor, on the hand, gives a measure of sphericity and a perfect sphere has a formfactor value of unity. The bulkiness factor gives an indication of solidity and large indentations on the particles give rise to low values (3).

For many users of image analyzers, a wider array of mathematical models is usually available on the software. The problem that confronts many users is not the mathematical treatment of image analysis data but rather the selection of an appropriate transformation model. Procedures for Fourier shape analysis and fractal measurement (4–7) are also available to allow further treatment of image analysis data. Indirect methods using two or more measurement techniques like sedimentation and sieving have also been used for particle shape determination (8). Vendors for image analysis systems include Data Translations, Malboro, MA; Edax, Mahwah, NJ; and Synoptics, Cambridge, U.K.

## 2.2. Particle Size

There is much literature on the measurement of particle size and size distribution. With the abundance of information on particle sizing and sizing methods, a less experienced operator can find it daunting as to which method is the best. Upon completion of a measurement, the task of data interpretation and validation of the accuracy and reliability of measurement can be difficult. Often, standards are used for comparison and the information obtained from these standards are used for calibration of the size measuring system. Standards used are very often ideal particles with a high degree of sphericity and a narrow size distribution. The real samples for size analysis are often not spherical and can have a considerably wide size distribution. It is therefore important to regard all results with some suspicion and in a comparative perspective, which depends on the standard calibrator used and the method of measurement. Proper and stringent development of the method for size measurement should be carried out to ensure reliability, reproducibility, and sensitivity of measurement method.

The present discussion on the particle sizing methods does not attempt to establish yet another theory and practice guide on particle sizing but to review the popular methods of particle sizing, their problems and usefulness in providing information valuable to a formulator. Little attempt will be made to explain the theories of various sizing methods as they are dealt with in many other comprehensive publications on this subject (8–10).

### 2.2.1. Microscopy

Microscopy is a very old technique capable of sizing fine powders accurately. It is nowadays regarded as an unpopular method to use due mainly to the tedium in measurement and the availability of more sophisticated and easy-to-use particle sizers.

Nevertheless, microscopy still presents as the most direct method of particle size analysis. However, as a particle sizer, a minimum of at least 625 particles must be measured for computation of reasonable size statistics (11). In a particle sizing laboratory, the value of the microscope is usually not as a primary equipment for particle sizing but rather for the preliminary examination of the size distribution of a powder sample prior to the use of a less direct particle size analyzer. The estimation of particle size characteristics obtainable from the microscope would certainly provide a rough guide for the setting of an automated particle sizer to the correct sizing range or checking if the size analysis data obtained are within an expected range.

Unlike other particle sizers, the microscope gives the operator a clear visual outline of each individual particle being measured. In addition, the material may be presented in its normal form, dry or in a liquid medium. Particles that are aggregated can be identified and will not be measured as a single entity. Problems associated with microscopic sizing lie not only in the tedious nature of the technique but also in the slide sample preparation, optical resolution, and operator bias.

Sample preparation for microscopy must ensure a representative distribution of particles on the slide to be used for sizing. When powder material is to be made as a suspension, there should be neither loss of smaller particles through dissolution nor loss of large particles due to sedimentation prior to transferring onto a slide. It is best to wet a sample on the slide itself. Presentation of the area of slide specimen for sizing must be carried out in a systematic and orderly manner by moving the slide to view different areas of the sample. There is an intrinsic orientation problem as particles when presented always find their most stable orientation. Microscopy involves measuring a particle from only the top view and measurement is two dimensional. Thus, flakes or discoids will tend to be oversized. Decision on the dimension(s) to measure needs to be made should a linear eyepiece graticule be used. An area graticule may also be employed for projected area determination. Orientation problems may be overcome by dispersing powders onto adhesive before viewing or setting particles in plastic or wax, which is then sectioned for viewing. These techniques will definitely make an already tedious technique even more so.

Clarity is always a problem as sizes of particles approach the lower limits of light microscope optics, which is about 1  $\mu\text{m}$ . The quality of lenses may also play a part. There is often a tendency to oversize slightly due to fringe effects around particles. Various microscope accessories and lighting techniques can improve the viewed image resolution to a varying extent. In some cases, the use of dyes can help improve the contrast between particle and background.

An operator with good technique is necessary in order to obtain reliable results with minimal systematic errors. Operator technique can influence accuracy of microscopic determination of particle size. There is a natural tendency for an operator to pay greater attention to large particles as he is less likely to miss them. Not only do small particles tend to be missed, they also pose problems by being hidden by the larger particles or appearing as clumps. However, in volumetric terms, small particles have a lesser influence.

Automation of the microscopy technique began with an image shearing technique (12) and progressed to image projection and measurement and, finally, computer image digitization and image analysis (13). The preceding discussion on particle shape has covered the use of image analysis. Information for particle size and size distribution is easily obtained from the set of data for deriving shape factor of the particles. An extension of light microscopy is scanning electron microscopy.

Measurements may be made directly from the video image or via photomicrographs. Attached image analysis systems may also be utilized for sizing. There have also been improved methods to incorporate image processing systems to microscopic methods. By taking images at varying focal distances, a composite image with highly sharpened edges can be digitally produced.

### 2.2.2. Sedimentation

Sedimentation technique for particle sizing and classification has been in use for a long time. In recent years, however, the success of light scattering particle sizers has effectively eroded away the market for sedimentation-based particle sizers. Sedimentation technique for sizing is based on the settling of particles under gravity described by Stokes' law. For a particle of diameter,  $d$ , and density,  $\rho_1$ , under the force of gravity,  $g$ , in a fluid of viscosity,  $\eta$ , and density,  $\rho_2$ , at its terminal velocity,  $\nu$ , the accelerating force due to gravity is balanced by the viscous drag and

$$\nu = \frac{d^2 g (\rho_1 - \rho_2)}{18\eta} \quad (2.4)$$

The Andreasen pipette introduced in the 1920s is perhaps the most popular manual apparatus for sampling from a sedimenting suspension. Determination of the change in density of the sampled particle suspension with time enables the calculation of size distribution of the particles. As Stokes' law applies only to spherical particles, the nonspherical particles give a mean diameter referred to as Stokes' equivalent diameter. The size range measurable by this method is from 2 to 60  $\mu\text{m}$  (8). The upper limit depends on the viscosity of liquid used while the lower limit is due to the failure of very small particles to settle as these particles are kept suspended by Brownian motion.

An improvement of the Andreasen pipette method is to use a pan attached to a sensitive balance which records the changes in weight of the pan as an increasing amount of suspending particles settle on it. Later, sedimentation techniques using light extinction by changes in turbidity of the suspension and x-ray were introduced for more sensitive and rapid measurements.

The introduction of centrifugal sedimentation makes the technique capable of determining the distribution of particles below 5  $\mu\text{m}$ . The lower limit depends on the centrifugal velocity. The time of analysis is reduced drastically and multiple samples in cells can be analyzed simultaneously.

### 2.2.3. Sieving

Sieving is probably the oldest method of sizing, used initially for particle classification rather than size analysis. The introduction of high-quality standardized woven-wire sieves in a  $\sqrt{2}$  progression, starting from 75  $\mu\text{m}$  has helped to establish sieving as a widely used particle sizing method, especially for the larger particles. Conceptually, particle sizing by sieving is easily understood as the different meshes classify the particles to different weight-based size fractions giving rise to the frequency distribution.

The process of sieving involves a nest of sieves, usually five to eight, arranged from the largest apertures to the finest followed by a receiving pan. The sieves with a lid and receiving pan are then placed on a sieve shaker, which may gyrate, oscillate, or vibrate the sieves. Most commonly used shakers are vibrators. It is important to determine the time required for completion of sieving. This is commonly taken as the time when there is no further change in the weight of material retained on each sieve

after additional sieving time is given. The load for sieve analysis should be sufficient in order that the amount present after sieving on each mesh can be accurately weighed.

In size analysis using sieves, it must be borne in mind that the aperture size of a given sieve is not an absolute cutoff value for the size of particles permitted to pass through. The permitted aperture tolerance is much wider and following the maximum tolerance allowed by the British Standard 410 (1976), particles from 55 to 95  $\mu\text{m}$  may go through or be arrested by a 75  $\mu\text{m}$  aperture size sieve. Particles tend to pass through based on their narrower cross-sectional area. An elongated particle, such as a rod-shaped particle, will pass through an aperture just larger than its minimum cross-sectional profile. Woven sieves can be made down to about 30  $\mu\text{m}$ . Finer sieves of much higher precision from 100  $\mu\text{m}$  down to a few micrometers can be made using etching methods and these sieves are often referred to as electroformed micro-mesh sieves. Sieves with bases that have accurately drilled or punched circular holes instead of woven mesh are available for sizing larger particles, generally about 500  $\mu\text{m}$  and larger.

Size analysis by sieving is a relatively slow process and there may be problems with dust pollution. For many drugs, the safety of the operator needs to be considered. In addition, wire mesh stretches with repeated use. Apertures may be blanked by improper or inadequate washing. For fine powders, aggregation of powders due to cohesive or electrostatic charges can give inaccurate results. Inadequate sieving time will also produce unreliable data. It is also important to ensure that the sieving process itself does not bring about size reduction.

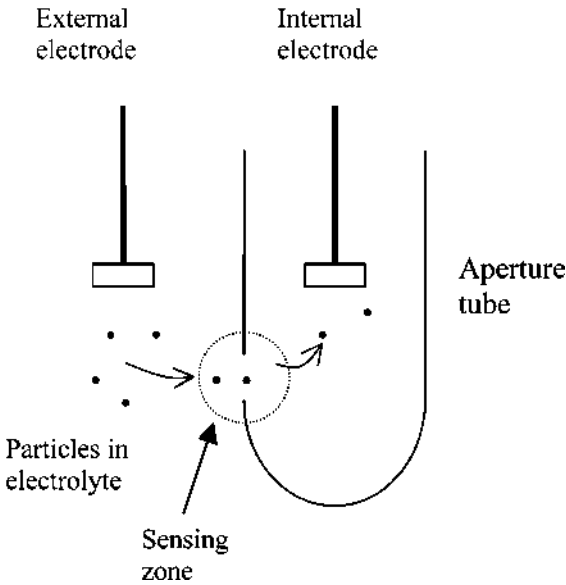
As sieving fine powder in a dry state may be a problem due to the cohesive nature of such a powder and a long sieving time is required, wet sieving by suspending the powder in a suitable liquid can improve sieving efficiency. However, the procedure becomes more tedious. It now requires the additional drying of size fractions. It is recommended that sieving starts with the finest mesh to remove the fines with a volume of liquid, followed by classifying the powder retained with the largest to the smallest mesh.

Air-jet sieving is a much more popular method for sizing fine powders below 75  $\mu\text{m}$  than wet sieving. It involves the use of a vacuum pump to remove air from the underside of a sieve. Air current is also supplied from the underside of the sieve through a rotating arm of jets, which helps to unclog the mesh. A collecting cyclone may be attached in the vacuum line to collect the fines. In-line filters may also be used to collect the fines. Air-jet sieving is usually used as a one-mesh sieving. For information of size distribution, composite size distribution may be obtained from separate air-jet sieving operations using different meshes for samples of the same powder.

A common point of discontent with size analysis using sieves is that the process requires quite a bit of preparatory work, weighing, and subsequent washing. Yet, a typical analysis would yield only seven to eight points on the size distribution and this may not be sufficiently discriminating. Nevertheless, sieving is a straightforward and robust technique suitable for a wide variety of fine to very coarse powders. Material properties such as density, optical property, water solubility, or conductivity are not required for computation of the particle size.

#### 2.2.4. *Electrical Sensing*

The electrical sensing zone principle, which is more commonly known as the Coulter principle, is based on a simple electrical property that the electrical resistance



**Figure 2** The Coulter principle.

between two compartments containing an electrolyte and connected by an aperture is proportional to the electrical conducting area of the aperture. Figure 2 illustrates the basic Coulter principle. By drawing electrolyte from one compartment to the other, particles streaming through will decrease the conducting area of the aperture. By fast time-based tracing of the resistance, resistance pulses coinciding with the passage of particles through the aperture will be obtained. The amplitude of the pulse is proportional to the volume of the particle. With a pulse analyzer, the Coulter counter can analyze a large number of particles within a short time.

Particle size range detectable depends on the aperture tube used. Each aperture tube is effective over a size range of about 2–40% of its nominal diameter. Apertures of sizes from 15 to 4000  $\mu\text{m}$  are available. Before use, it is necessary to calibrate the equipment with a standard latex containing monosize spherical particles of mean size within 5–20% of the aperture diameter.

When working with small apertures, aperture blockage may be a problem. With large apertures for sizing large particles, settling of the large particles may give rise to sizing errors. It is important that the material for sizing is nonconductive and nonporous. For porous particles, sizing values obtained may be much smaller than those derived by visual inspection. Prior to addition of the powder for sizing, it is necessary to ensure a low background count. When dispersed in the electrolyte, the powder particles must not be flocculated and do not dissolve in the electrolyte solution. Care must be taken to ensure proper dispersion of powder. The concentration of particles must be within the range acceptable. Higher concentration will result in higher errors due to coincidence while low concentration will necessitate a longer counting time.

### 2.2.5. Light Scattering

There has been a tremendous growth in the application of light scattering technique for particle sizing in recent years and light scattering particle sizers have taken a

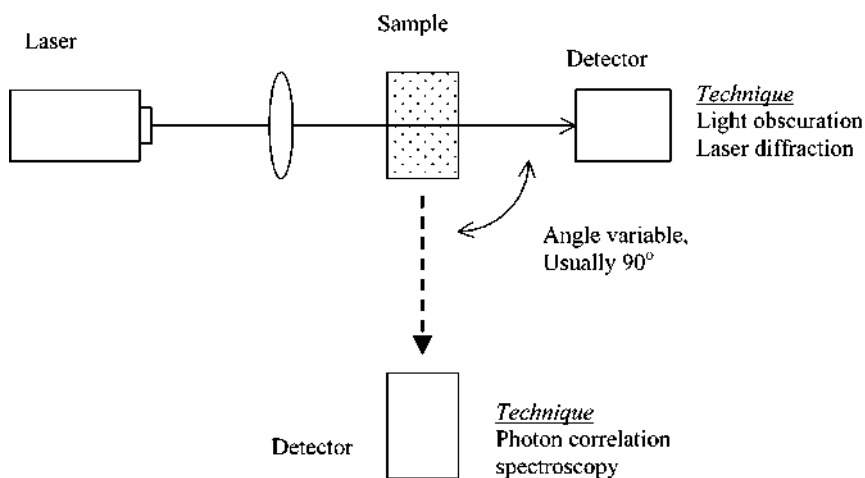
lion share of the market for particle sizers. The large number of manufacturers of instruments using light scattering technique has also a hand in convincing many laboratories of their need for such a sizer. It is however unfair to ascribe the recent popularity of light scattering sizing to just its marketing. Light scattering particle sizers for both wet and dry samples are indeed much easier to use and are highly efficient. The measurement time is short and the method is able to produce detailed and reproducible particle size information.

Without dwelling on the theories of light scattering, particle sizers using this principle can be roughly divided into three groups, two for determining particle size down to about 1  $\mu\text{m}$  using light obscuration and laser diffraction and the third, for submicron particle size using photon correlation spectroscopy. A schematic diagram of the various techniques of light scattering is shown in Figure 3.

Light obscuration or blockage technique involves measuring particles singly. The passage of a particle across the light beam produces a reduction in the amount of transmitted light which is detected by a sensor directly opposite the incident light. The pulses are then classified, giving the frequency distribution. The degree of light diffraction, opacity, and orientation of the particle as it passes the light beam can affect the extent of light blockage and may affect measurement accuracy.

As a small particle passes through a beam of light in a laser diffraction sizer, it will scatter light, which will be directed onto a diode array detector directly opposite the incident light. The detector has a series of photodiodes arranged outward from a central photodiode detector. Since the intensity of the light scattered decreases as the scatter angle increases, photodiode elements are generally larger as they are further from the center. Calculations for particle size and size distribution involve rather complex mathematics. Simply put, sizing of a particle is based on the angle of diffracted light, with small particles diffracting at wider angles than larger particles. Thus, from the light scattering pattern, information on the size distribution of the particles can be obtained through a series of complex calculations.

Sample presentation for light obscuration sizer involves the dispersion of the particles in a liquid medium like in the case of the electrical sensing sizer. The main difference is that light obscuration sizer may operate in the absence of an electrolyte.



**Figure 3** Schematic diagram for light-scattering particle sizing.

For laser diffraction, sizing may be carried out on both particles dispersed in liquid as well as dry powders using dry powder feeders. Laser diffraction is also very useful for sizing aerosol particles and sprays. Increasingly, there has been an attempt to use information from diffraction to elucidate shape parameters.

The possibility of measuring the particle size and size distribution of powders in their dry state with an acceptable level of accuracy and in a very short timespan has attracted many laboratories. For many users, the laser diffraction sizer is an efficient equipment for producing detailed and accurate size distribution information of the powder particles. However, the sizing of some powders using a dry powder feeder with the laser diffraction sizer can be fraught with problems. Possible causes of non-reproducible results are the poor control of ambient humidity, cohesive nature of the powder, powder particles that fragmentate easily, large size span of the particles, variable rate of introduction of particles during measurement period, possible segregation of powders during introduction, and stray powder particles depositing on the lens. The sizing of a powder composed of very large and very small particles can be problematic as a portion of the small particles will adhere onto their larger counterparts. The complete dislodging of the smaller particles can be an extremely difficult task and with different feed rates of particles for sizing, different results may be obtained. In addition, humidity of the atomizing air can also affect sizing results.

#### 2.2.6. *Photon Correlation Spectroscopy*

The measurement of submicrometer particles had been difficult until the introduction of photon correlation spectroscopy for particle sizing. This technique enables particles from a few nanometers to a few micrometers to be measured. The measurement principle involves the determination of fluctuations in the scattered light intensity at an angle (Fig. 3). These fluctuations are the result of Brownian motion of suspended particles in the liquid. Large particles will diffuse more slowly than smaller ones and therefore, the rate of decay in intensity of scattered light at a particular measuring point will depend on the size of the particle. The particle size distribution is computed using complex calculations and approximations from the intensities of scattered light (normally at  $90^\circ$  to the incident beam) and their rate of decay. Multiple angle measurements are sometimes applied to improve the quality of the size parameters obtainable.

Although the photon correlation sizer represents a very interesting instrument for the sizing technologist, powders for granulation do not generally fall into the submicrometer range. The few possible uses of this instrument are in the evaluation of polymeric materials employed for binding and coating. Suppliers for both laser diffraction and scattering particle sizers include Beckman Coulter, Fullerton, CA, USA; Hach Ultra Analytics, Grant Pass, OR, USA; Malvern Instruments, Worcs, U.K.; and Horiba, Kyoto, Japan.

### 2.3. Particle Surface Area

Surface area measurement is usually carried out by either gas permeability or adsorption. The technique of gas permeability depends on measuring the resistance to gas flow through a packed bed of particles. It is important that packing of the bed is uniform and from the volumetric flow rate of the gas through and pressure drop across the bed, the specific surface area of the powder can be calculated. The measurement of specific surface area by gas permeability does not take into account



the very small pores or fissures since the flow of gas is not hindered as it passes over them. More accurate measurements can be made by measuring gas flow under reduced pressure but still, the accuracy cannot match that obtainable by gas adsorption if the total area to be determined includes those of the fine pores. Although gas permeability gives a lower specific area for a powder compared with gas adsorption, the value obtained is sometimes more useful in explaining factors like lubricity and flow, which would not involve the micropores present in the particles.

Gas adsorption is carried out by placing a powder sample in a chamber and evacuating the air within. The latter process is commonly referred to as degassing. Upon achieving a very high vacuum, known volumes of an adsorbing gas are introduced. From the knowledge of pressures and temperatures before and after introduction of the adsorbing gas, usually nitrogen, calculations of total sample surface area can be made. The surface area determination by gas adsorption is based on a simple principle. From Avogadro's number, a known volume of air at a certain temperature and pressure contains a determinable number of molecules. When varying volumes of gas are introduced to a degassed sample, the small pressure changes in the chamber are recorded and using a calculation technique known as the BET method, the initial amount of gas molecules which are adsorbed onto the surface forming a monolayer can be calculated. Thus, the surface area covered by the gas molecules can be determined by multiplying the number of molecules needed with the surface area occupied per molecule. Samples are usually cooled to a low temperature using liquid nitrogen. There are variations in the technique for gas adsorption by different instrument manufacturers (14).

In addition to determining the specific surface area, pores below 50 nm may also be characterized by gas adsorption. Distribution of larger pores, 0.003–0.004  $\mu\text{m}$ , can be determined by mercury intrusion porosimetry technique, where the volume of mercury intruded under pressure represents the volume of pores whose entrant diameter can be calculated from the applied pressure (15). The main suppliers of equipment for surface and porosimetry include Quantachrome, Boynton, FL, USA, and Micromeritics, Norcross, GA, USA.

### 3. SOLUBILITY

The solubilities of drugs and excipients are an important physicochemical property as they affect the bioavailability of the drug, the rate of drug release into the dissolution medium, and consequently, the therapeutic efficacy of the pharmaceutical product. It must be borne in mind that a drug must first be in solution in order to be absorbed into the blood circulation. If the solubility of the drug is less than desirable, steps must be taken to improve its solubility or to use another more soluble drug form. Excipients which are poorly soluble in water might retard the release of drug into the dissolution medium. Hence, the determination of drug and excipient solubilities constitutes an important aspect of formulation study.

The solubility of a material is usually determined by the equilibrium solubility method, which employs a saturated solution of the material. The saturated solution is obtained by stirring an excess of the material in the solvent for a prolonged period of time at a constant temperature until equilibrium is attained. As a guide, stirring the mixture overnight is usually adequate for achieving equilibrium. The saturated solution can also be obtained by warming the solvent with an excess of the material and allowing the mixture to cool to the required temperature. This, however, may

produce a supersaturated solution for some materials and therefore, heating should be applied with caution. A portion of the saturated solution obtained by either method is then removed with the aid of a syringe through a membrane filter at different time intervals. The determination is completed only if at least two successive samples have the same results, indicating that equilibrium is attained. The final value thus obtained is the solubility of the material. The material present in the sample of saturated solution may be assayed by a variety of methods such as UV spectrophotometry, electrical conductivity measurement, gravimetric or volumetric analysis, and chromatographic methods.

The following precautions should be observed in order to obtain accurate and reproducible solubility values:

- The material and solvent must be pure
- The temperature must be properly controlled
- It is essential that some undissolved material is present in the solution to ensure that the solution obtained is saturated
- The saturated solution used for assay must be free from undissolved material
- The method of assay must be reliable

A good understanding of the factors affecting solubilities of materials is pertinent in explaining the changes in solubility under different conditions. These factors can therefore be employed to improve the solubility and bioavailability of various drugs.

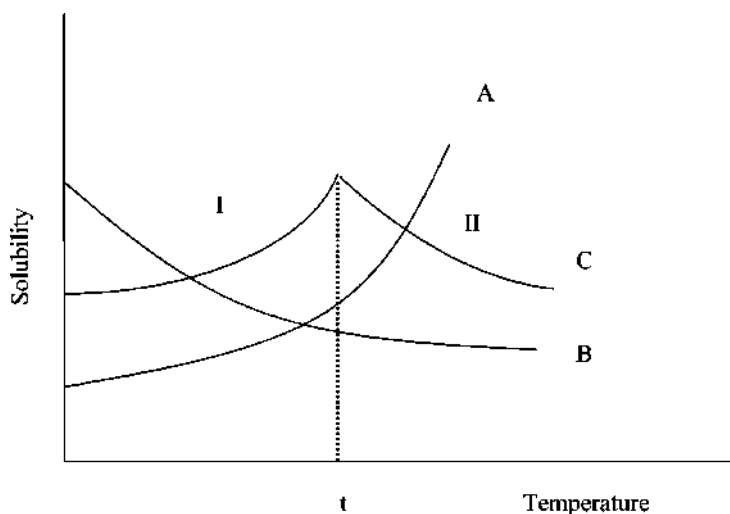
### 3.1. Nature of Solvent

Some materials dissolve very readily in a solvent while others dissolve sparingly. The solubility of the material in a given solvent depends on the ability of the solvent to overcome the forces that bind the atoms or molecules of the material. Studies have shown a definite correlation between the solubility and the molecular structures of the material and solvent. It is noted that the greater the similarity in molecular structure, the higher would be the solubility of the material in the solvent. As a rule, polar materials dissolve readily in polar solvents and nonpolar materials in nonpolar solvents. Materials with both polar and nonpolar groups in their molecules may dissolve in polar solvents but their solubilities tend to decrease as the proportion of nonpolar groups in the molecule increases.

A large number of materials have poor solubilities in water and often pose a problem in the formulation of pharmaceutical products. Addition of another solvent, in which these materials are more readily soluble, will increase the concentration of the materials in the solution. This additional solvent is known as a cosolvent and common examples include glycerin, sorbitol, propylene glycol, and polyethylene glycols. The proportion of cosolvent required varies from system to system.

### 3.2. Temperature

The solubilities of most materials increase with rising temperature due to their endothermic dissolution process. Similarly, the solubilities of materials which exhibit exothermic dissolution decrease with rising temperature. The relationship between



**Figure 4** Typical solubility curves.

solubility and temperature is expressed by solubility curves. Three typical solubility curves are shown in Figure 4.

A material whose solubility increases with rising temperature exhibits a continuous curve with a positive slope (Curve A) while that whose solubility decreases with rising temperature exhibits a negative slope (Curve B). Some solubility curves show an abrupt change in slope at certain temperatures (Curve C). This phenomenon is attributed to the change in nature of the material at the temperature where the slope changes direction. For example, the solubility curve C is derived from a material which can exist in two forms. The curve shows that Form I is converted to Form II at temperature  $t$ . The dissolution of Form I in water is endothermic, which explains the increasing solubility of the material with rising temperature until  $t$ . Above this temperature, Form I is converted to Form II, which exhibits exothermic dissolution. The slope of the solubility curve therefore changes from positive to negative as the temperature exceeds  $t$ .

### 3.3. Crystal Characteristics

Materials may exist as amorphous or crystalline substances. Some materials such as cortisone, tetracycline, sulfathiazole, and chloramphenicol palmitate can exist in more than one crystalline form and this property is described as polymorphism. The different crystalline forms which are known as polymorphs exhibit different degrees of stability. The lattice structure of the crystalline substances may be altered by the incorporation of molecules of the solvent from which crystallization occurs. The resultant crystals obtained are called solvates. If the solvent is water, the crystals are said to be hydrated.

The different forms of a material have varying solubilities. The amorphous substance is more soluble than the crystalline counterpart. Among the crystalline forms, the metastable polymorphs are generally more soluble than the stable polymorphs. Hydrated crystals tend to exhibit a lower solubility in water compared with their anhydrous form. On the contrary, the aqueous solubilities of the nonaqueous solvates are often greater than those of the unsolvated forms.

### 3.4. Particle Size

It is important to distinguish equilibrium solubility from intrinsic solubility of a material. Unlike intrinsic solubility, equilibrium solubility is not affected by the particle size of the material. The solubilities of materials reported in the literature generally refer to the equilibrium solubilities. The method of determining equilibrium solubility is given in an earlier section.

The intrinsic solubility of a material is dependent on the particle size of the material. Smaller particles have a higher intrinsic solubility compared with their larger counterparts. This is aptly explained by the existence of a higher interfacial free energy on smaller particles resulting in a thermodynamically unstable system which is corrected by greater dissolution of the particles and production of a supersaturated solution. The increase in intrinsic solubility with decrease in particle size, however, ceases when the particles have a very small radius and any further decrease in particle size causes a decrease in intrinsic solubility.

### 3.5. pH

The solubility of a material will be affected by the pH of the liquid medium if the material is acidic or basic. For example, a weakly acidic drug is more soluble in an alkaline solution while a weakly basic drug is more soluble in an acidic solution. This phenomenon is due to the formation of more soluble salts as a result of acid–base reaction. Conversely, the weakly acidic drug will precipitate from the solution if the pH is lowered by the addition of an acid while the weakly basic drug will precipitate from the solution if the pH is raised by the addition of an alkali. The precipitation is a result of the conversion of the drug in solution to the less soluble unionized form.

The relationship between pH and solubility of a material is given by Eqs. 3.1 and 3.2. These equations which are modified from the Henderson–Hasselbalch equation are useful in the estimation of the solubility of materials under different pH conditions.

For acidic materials,

$$\text{pH} = \text{pKa} + \log \frac{S - S_0}{S_0} \quad (3.1)$$

For basic materials,

$$\text{pH} = \text{pKa} + \log \frac{S_0}{S - S_0} \quad (3.2)$$

where  $S$  is the overall solubility of the drug and  $S_0$  is the solubility of its unionized form.

### 3.6. Additives

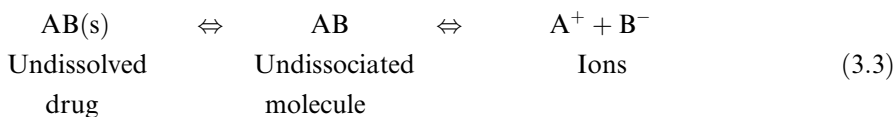
Additives refer to other substances incorporated into the solvent in which the drug is dissolved. The drug in the solution may exist as ionized or nonionized forms. Drugs that dissociate in the solvent to form ions are described as ionizable while those that do not dissociate are nonionizable. Like the drugs, some additives ionize readily in the solvent while others do not. Among the additives that ionize, some produce a similar ion to the drug. The effect of additives on the solubility of a

drug depends on the nature of the drug as well as the additives. For ease of understanding, the additives will be classified as common ions, indifferent electrolytes, and nonelectrolytes.

### 3.6.1. Effect of Common Ions on the Solubility of Ionizable Drugs

The solubility of a sparingly soluble drug is decreased by an additive that possesses a similar ion to the drug. This phenomenon which is a result of common ion effect can be explained by the Law of Mass Action.

The equilibrium of a saturated solution in the presence of undissolved drug is represented as follows:



If the material is sparingly soluble, the concentration of dissolved drug is sufficiently small to assume complete dissociation into ions. The overall equilibrium may therefore be expressed as:



From the Law of Mass Action, the equilibrium constant ( $K$ ) for this reversible reaction is given by the following equation:

$$K = \frac{[\text{A}^+][\text{B}^-]}{[\text{AB(s)}]} \quad (3.5)$$

where the square brackets indicate the concentrations of the respective components. Since the concentration of a solid may be regarded as being constant, Eq. 3.5 can be rewritten as:

$$K'_s = [\text{A}^+][\text{B}^-] \quad (3.6)$$

where  $K'_s$  is a constant which is known as the solubility product of the drug AB. Some drugs have molecules which contain more than one ion of each type. The equilibrium and solubility product of these drugs are similarly expressed as:



$$K'_s = [\text{A}^+]^x[\text{B}^-]^y \quad (3.8)$$

If the additive dissociates to produce either  $\text{A}^+$  or  $\text{B}^-$ , the concentrations of these ions in the solvent will increase. As a result, the product  $[\text{A}^+][\text{B}^-]$  or  $[\text{A}^+]^x[\text{B}^-]^y$  will also increase. It should be recalled that  $K'_s$  is a constant. Therefore, if  $K'_s$  is exceeded by the product of the concentrations of ions, the equilibrium will move toward the left in order to restore the equilibrium and the drug will be precipitated. This explains the decrease in the solubility of a drug by common ion effect.

### 3.6.2. Effect of Indifferent Electrolytes on the Solubility of Ionizable Drugs

Additives which dissociate to form ions different from those of the drug are known as indifferent electrolytes. Unlike common ions, indifferent electrolytes may increase the solubility of a sparingly soluble drug.

The solubility product defined by Eq. 3.6 is only an approximation from the more exact thermodynamic relationship expressed by the following equation:

$$K_s = \alpha_{A^+} \cdot \alpha_{B^-} \quad (3.9)$$

where  $K_s$  is the solubility product of drug AB and  $\alpha_{A^+}$  and  $\alpha_{B^-}$  are the activities of the respective ions. The activity of an ion is defined as the effective concentration of the ion in solution. It generally has a lower value than the actual concentration because some of the ions are “taken out of play” by strong association with oppositely charged ions.

At infinite dilution, the wide separation of ions prevents interionic association and the actual concentration and activity of the ion are equal. This situation is applicable to a sparingly soluble drug where the concentrations of ions produced are so small that the ions are completely unassociated. Therefore, the solubility product can be expressed by Eq. 3.6. However, if the concentration of ions increases, the effects of interionic association are no longer negligible and the activity becomes less than the actual concentration. The activity coefficient, which is the ratio of activity to actual concentration (Eq. 3.10), indicates the extent of interionic association. An activity coefficient of unity shows that the ions are completely unassociated while smaller values show greater interionic association:

$$\frac{\alpha_{A^+}}{[A^+]} = f_{A^+} \quad \text{or} \quad \alpha_{A^+} = f_{A^+} \cdot [A^+] \quad (3.10)$$

where  $f_{A^+}$  is the activity coefficient of ion A.

Eq. 3.9 can thus be expressed as:

$$K_s = f_{A^+} \cdot [A^+] \cdot f_{B^-} \cdot [B^-] = f_{A^+} \cdot f_{B^-} \cdot [A^+] \cdot [B^-] \quad (3.11)$$

According to Eq. 3.6, the product of the concentrations is the constant  $K'_s$ . The product of the activity coefficients of the respective ions may be equated to  $f_{A^+B^-}^2$ , where  $f_{A^+B^-}$  is the mean activity coefficient of the drug. Hence,

$$K_s = K'_s f_{A^+B^-}^2 \quad (3.12)$$

The value of the activity coefficient decreases from unity as the overall concentration of ions of the solution increases. Since  $K_s$  is a constant, it follows that  $K'_s$  will increase with the ionic strength and become larger than  $K_s$ . The increase in the solubility of a drug by the addition of indifferent electrolytes is attributed to the increase in the ionic strength of the solution due to the indifferent electrolytes.

### 3.6.3. *Effect of Nonelectrolytes on the Solubility of Ionizable Drugs*

The solubility of an ionizable drug depends on the dissociation of the drug into ions. The degree of dissociation is affected by the dielectric constant of the solvent. Solvents with a high dielectric constant, being polar in nature, are able to reduce the forces that attract the oppositely charged ions produced by dissociation of the drug. Addition of a nonelectrolyte such as alcohol will lower the dielectric constant of the solvent. This will decrease the dissociation and, subsequently, solubility of the drug.

### 3.6.4. *Effect of Electrolytes on the Solubility of Nonionizable Drugs*

Nonionizable drugs do not dissociate into ions in solution. They exist as single molecules and their solubility in the solvent depends on the formation of weak

intermolecular bonds with the molecules of the solvent. For example, the solubility of the drug in water is dependent on the formation of hydrogen bonds between the molecules of the drug and water. When an electrolyte is added, it will dissociate to form ions which have a high affinity for water. These ions will compete with the molecules of the drug for water and reduce the solubility of the drug in water.

### 3.6.5. *Effect of Surfactants*

Surfactants are solutes that cause a marked decrease in the surface tension of the solvent. These substances are commonly employed as solubilizing, wetting, and emulsifying agents. They are composed of a lipophilic group that has little affinity for water and a hydrophilic group that has strong affinity for water. At a specific concentration known as the critical micellar concentration, the surfactant molecules exist as large aggregates called micelles. In an aqueous system, the hydrophilic group is orientated on the exterior while the lipophilic groups are on the interior of the micelles. Drugs which are poorly soluble in water may be taken into the interior of these micelles, resulting in more of the drug being able to go into solution. The enhanced solubility obtained as a result of the solubilization phenomenon is known as the apparent solubility of the drug.

### 3.6.6. *Effect of Complex Formation*

The amount of drug that can go into solution may be altered by the addition of a substance which interacts with the drug to form a complex. The solubility of the complex will determine the apparent solubility of the drug. If the complex is more soluble than the drug, a larger amount of the drug will dissolve to form the complex. Thus, the drug will show a higher solubility in the solvent. Similarly, if the complex is less soluble, some of the drug will be precipitated in the form of the complex. The drug will therefore show a lower solubility in the solvent. It should be borne in mind that the modified solubility obtained is not the solubility but the apparent solubility of the drug.

## 4. CRYSTAL PROPERTIES AND POLYMORPHISM

Materials may occur as amorphous substances without any definite structure or as crystalline particles with a definite structure and shape. Some materials may exist in more than one crystalline form (polymorph) and are described as exhibiting polymorphism. The type of crystal formed depends on the conditions, such as temperature and type of solvent, under which crystallization is induced. At a specific temperature or pressure, more than one polymorph can exist but only one will be thermodynamically stable. The less stable or metastable forms will be converted to the stable form with time. Studies show that it may take from minutes to years to revert to the stable lattice structure.

The different crystalline forms of a material generally differ in many physical characteristics, such as solubility, melting point, optical and electrical properties, density, hardness, and stability. The use of metastable polymorphs frequently results in higher solubility and dissolution rates while the stable polymorphs are often more resistant to chemical degradation. It is obvious that any change in the crystalline form will affect the therapeutic efficacy of a pharmaceutical product. Therefore,

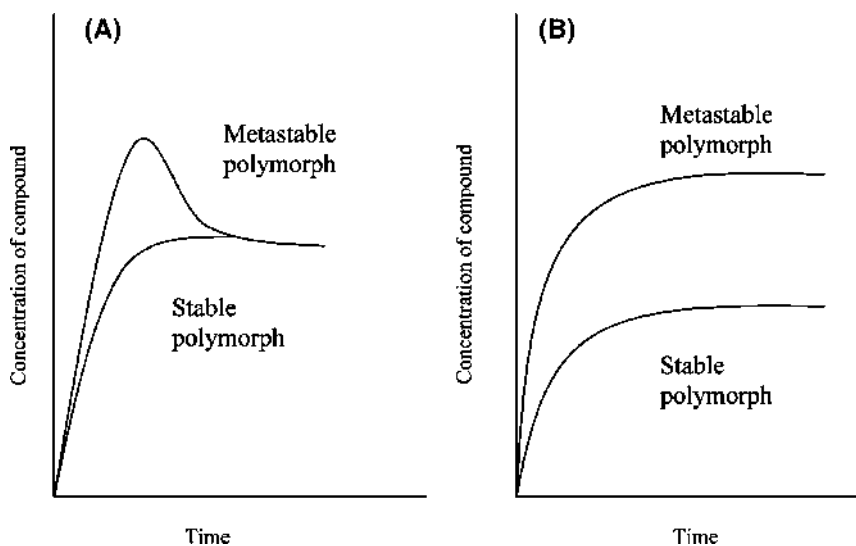
knowledge of the crystalline form of a drug in the formulation of pharmaceutical products is very important and steps should be taken to ensure that the crystals do not convert from one form to another during production and storage of the product. Some problems which may arise if the crystal properties of the drug are not properly characterized are precipitation, low stability, and poor bioavailability of drug. The significance of polymorphism in pharmacy is discussed in detail by Haleblan and McCrone (17).

A number of techniques may be used to identify the crystalline form of a material. It is advisable to employ more than one method in the analysis as the use of only one method has been found to be unreliable at times.

#### 4.1. Dissolution Study

An amount of the material in excess of its solubility is added to the dissolution medium and aliquot samples are removed and assayed at appropriate time intervals. The concentration of the material in solution as a function of time is then plotted. The crystalline form which constitutes the material is reflected by the shape of the dissolution curve. The typical dissolution profile of metastable polymorph which readily reverts to the stable form is shown in Figure 5A.

The concentration of the metastable polymorph is noted to increase much more rapidly at the initial period of the dissolution study and then drop to that of the stable polymorph. For the stable polymorph, the dissolution profile just increases gradually to a plateau. The solubility of the metastable form is indicated by the peak of its dissolution curve. In some cases, the metastable polymorph does not revert readily to the stable form. The dissolution curve of such a metastable form lies above that of the stable form, indicating that the former is more soluble (Fig. 5B). The plateau of each curve indicates the solubility of the respective polymorph.



**Figure 5** Typical dissolution profiles.



## 4.2. X-Ray Diffraction

Crystalline materials in powder form exhibit characteristic X-ray diffraction patterns with peaks of varying heights and in different positions. These diffraction patterns are also known as X-ray diffractograms. A typical X-ray diffractogram is illustrated in Figure 6.

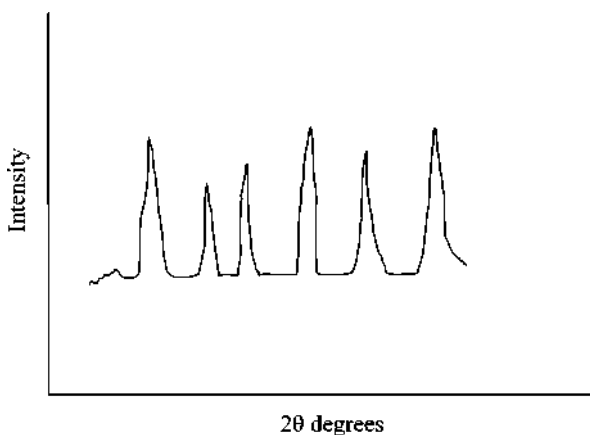
The polymorphs of a material have different crystal packing arrangements and thus produce differences in their diffractograms from which the crystalline form of the material is identified. This method of analysis is nondestructive and requires a very small sample of the material which can be examined without further processing. X-ray diffraction studies are especially useful for investigations on the changes of crystal form during processing. In some cases, the extent of the conversion of a crystalline drug to the amorphous form can be determined.

Conventional X-ray diffraction method cannot distinguish polymorphs which have relatively small crystallites because of the low resolution of diffractometers. Synchrotron sources have been employed to obtain high-resolution electron diffraction patterns which enable differentiation of such polymorphs (18). The development of very sensitive charge-coupled detectors (CCD) has allowed electron diffraction patterns to be recorded in a few seconds using very low electron currents.

## 4.3. Infrared Analysis

As mentioned earlier, the polymorphs of a material show varying crystal packing arrangements and produce different X-ray diffractograms. The crystal packing arrangement also affects the energy of molecular bonds and results in different IR spectra for the polymorphs of a material. Identification of the crystalline form of a material is based on the spectrum derived. Infrared (IR) analysis can be used for both qualitative and quantitative identification. It is important to use only materials in the solid form as the polymorphs of a material in solution have identical IR spectra.

In the area of substance identification, near IR is increasingly being used for confirming the identity of a chemical substance. Chemometric methods using



**Figure 6** Typical X-ray diffractogram.

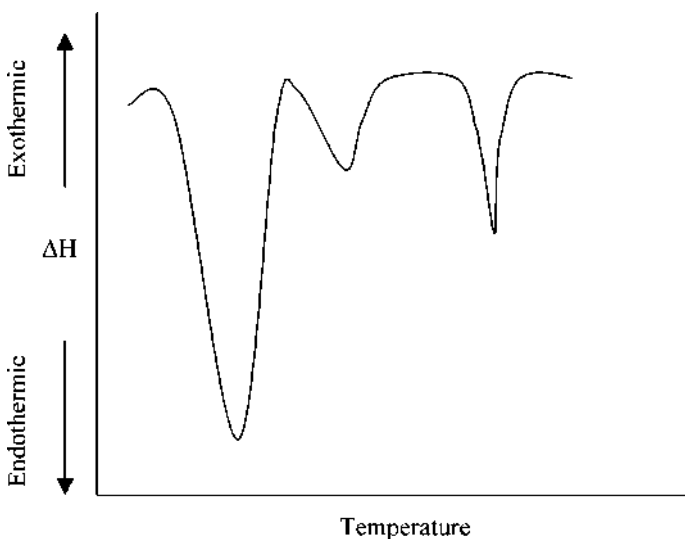
near IR have also been developed for source identification of pharmaceutical products.

#### 4.4. Thermal Analysis

In this method, the polymorphs are identified by their thermal behaviors. The change in energy of the polymorph as it undergoes transformation when it is heated is recorded as a thermogram. An example of a thermogram is given in Figure 7. The thermogram consists of characteristic peaks, including melting point ( $T_m$ ) and glass transition temperature ( $T_g$ ). The peaks pointing downward indicate endothermic changes such as melting, sublimation, and desolvation. The different polymorphs of a material will exhibit different thermograms which allow them to be identified.

Differential scanning calorimetry (DSC) and differential thermal analysis (DTA) are two methods of thermal analysis commonly used for these studies. In DSC, the energy resulting from the crystalline transformation is recorded as a function of temperature. In DTA, the energy is expressed by differential temperature (sample vs. inert substance).

Conventional DSC has a major limitation: if a  $T_g$  occurs in the same temperature range as another transition, for example, water or solvent loss, the two events cannot be separated. This limitation may be overcome by employing modulated temperature DSC (MTDSC), where the measurements are conducted using sine wave temperature programs defined by underlying heating rate, amplitude, and period. The heat capacity change associated with the  $T_g$  can be separated from the heat flow changes caused by melting, drying, and solvent loss. By use of the phase angle curve produced from the MTDSC data analysis, very small changes in specific heat can be detected, thereby increasing the sensitivity of the method. Based on thermal behavior, MTDSC is able to differentiate the amorphous and polymorphic forms of a material with much greater clarity (19). One of the disadvantages of this



**Figure 7** Example of a thermogram.

method is that the data analysis and interpretation are more difficult than for DSC. In addition, the experiment process can be long as much lower heating rates are used.

#### 4.5. Hot Stage Microscopy

The polarizing microscope fitted with a hot stage is very useful for identifying the crystalline forms of a material. In this method, the polymorph is heated to a temperature at which it undergoes a change in birefringence and/or appearance which is characteristic of the polymorph.

#### 4.6. Raman Spectroscopy

Raman spectroscopy provides molecular information about the crystalline, as well as the amorphous forms of a material. In this method, the material is subjected to a laser beam and a spectrum of the scattered light obtained. The spectrum shows vibrational bands of the material at their characteristic frequencies. The amorphous and polymorphic forms of a material can be distinguished by their characteristic spectra.

Raman spectroscopy and IR spectroscopy complement each other. The former measures a change in polarization whereas the latter measures a change in dipole moment. IR-inactive vibrations can be strong in Raman spectra and vice versa. For example, vibrations in the region of  $10\text{--}400\text{ cm}^{-1}$  are more easily studied by Raman than by IR spectroscopy.

One advantage of the Raman spectroscopy method is that no sample preparation is required, thus the likelihood of inducing phase changes through processing is reduced. However, representative sampling is critical for quantitative analysis (20). The results are affected by the particle size of the material. The use of Fourier transform Raman spectrometers with a longer wavelength laser of  $1064\text{ nm}$  eliminates the problem of any fluorescent background. With the utilization of fiber optics, real-time crystallization can be monitored (21). Thus, this method is useful for on-line analysis of pharmaceutical processes.

#### 4.7. Solid-State Nuclear Magnetic Resonance Spectroscopy

Solid-state nuclear magnetic resonance (SSNMR) spectroscopy is a more advanced method for differentiating the polymorphs of a material. The substance is placed in a strong magnetic field and subjected to radiofrequency radiation. The individual nuclei experience different magnetic environments and thus show different changes in resonant frequency characterized by chemical shift. SSNMR spectra show sharp resonance at chemical shifts characteristic of the molecular and crystal structure. The polymorphs are differentiated by their characteristic spectra.

This method is suitable for the study of molecular motions in a wide range of time scales ( $\approx 10^2\text{--}10^{-10}$  sec) and thus complements the X-ray diffraction method, which is limited to motions that are relatively fast ( $\approx 10^{-18}$  sec). It has a few advantages. It can be used for characterization of solid-state forms that cannot be crystallized and studied by the X-ray diffraction method. It is also useful for quantifying components of heterogeneous mixtures. In contrast to IR and Raman spectroscopy, the results are less affected by the particle size of the test material.

## 5. OTHER PHYSICAL PROPERTIES

It is undoubted that the type of physical characterization tests for a drug or excipient depends very much on the material concerned as well as the processing involved. Material testing can be broadly divided into two types, namely physical testing and functionality testing. Physical testing, which is used to determine properties such as size, solubility, and crystal form is generally more direct and the procedures are better established. Functionality testing which evaluates, for example, lubricity, flow, creep, and tack is less well established but, if carried out, may yield useful information about the raw materials and their potential effects on the processing.

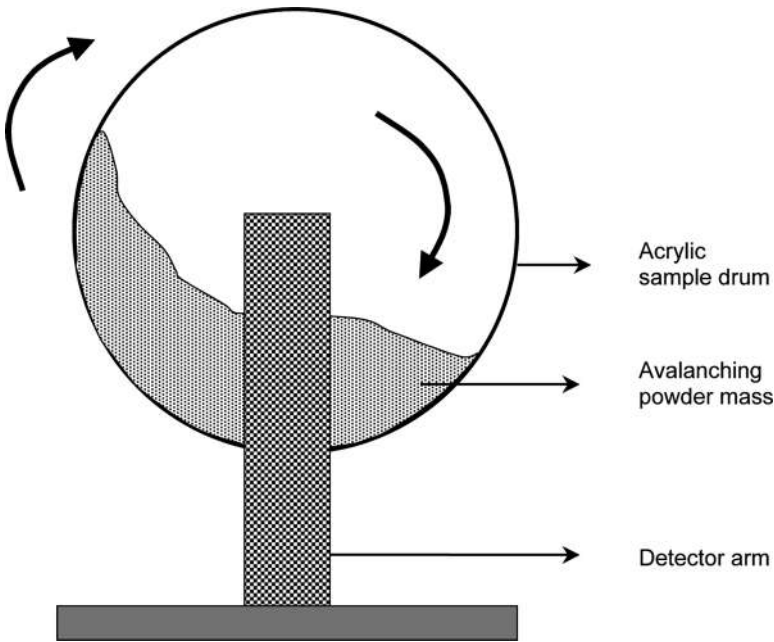
With the introduction of automated helium pycnometer, true densities of raw materials can be determined with ease and at a high degree of accuracy. The true density can serve to assure the formulator the identity of the material and sometimes reveal the state of raw materials, like partial changes of a powder from anhydrous to hydrated form.

Packing studies of the powder can reveal its rheological properties. These studies are carried out by filling a volumetrically calibrated cylinder with powder and tapping it. From the weight of powder filled and the changes in volume of the powder on tapping, changes in apparent densities can give information about the powder flowability (22). A small change in apparent density before and after tapping indicates good flow properties. The Hausner ratio, the ratio of tapped density to poured density has been found to be extremely sensitive to particle shape (23). The poured density is the undisturbed packing density of a powder in a calibrated cylinder after filling, usually done by passing powder through a sieve. The tapped density is the packing density after tapping a bed of powder until no change in the packing density is seen. An alternative expression used to predict powder flowability is the compressibility index or Carr index, which is the ratio of the difference between the tapped and poured densities to the tapped density, expressed as a percentage.

Flowability of a powder may be determined directly using a flow cup, which is often vibrated, or indirectly by the angle of repose. The angle of repose measurement usually involves forming a conical powder heap and measuring the maximum inclination of heap. The powders that can flow well give small angles of repose. A variation of the heap forming measurement is to use a loosely packed powder bed or transparent cylinder partially filled with powder and slowly rotating the powder bed away from the initial horizontal plane of the powder surface. The angle of inclination when sliding of powder just occurs is used to characterize the powder flowability. Determination of powder avalanches is a simple and efficient way to evaluate the flow properties of pharmaceutical powders. Powder flow properties are assessed by comparing their flow indices using a powder flowability analyzer (TSI Incorporated, USA). The flow analyzer consisted of a transparent acrylic drum fitted on a vertical bayonet-type mount (Fig. 8).

The drum could be programmed to rotate at user-defined rates. A metal mesh collar was fitted onto the inner circumference of the drum to prevent the sliding of powder particles down the circumferential wall instead of avalanching. Test powders should be sieved before being poured into the sample drum.

Analysis should be performed at a range of drum speeds in order to determine the flow index, as calculated by the equation described as follows:



**Figure 8** Avalanche powder flowability tester.

$$\text{Flow index} = \frac{1}{n} \sum_{i=1}^n S_i \quad (5.1)$$

where  $n$  is the total number of speeds tested and  $S_i$  is the standard deviation of the tested speed.

Strange attractor diagrams are generated by plotting the time difference between each avalanche and the next formed throughout the test duration. These plots provide a visual comparison of the flow properties of powders. Free-flowing powders will generate strange attractor diagrams that are dense and closer to the origin. In addition, their calculated flow indices will be correspondingly small.

Shear studies of powder bed can also be carried out to evaluate the cohesiveness of powders. There are many variations of shear cells for evaluation of powder cohesiveness.

The change in the packing properties of powders under pressure is used to study the compactability of powders. This study can be made using compression punches attached to pressure transducers (24). The force exerted and the displacement can be utilized to calculate useful parameters for assessing the compactability of a powder or powder mix.

For polymers, mechanical testing such as creep testing of films formed can provide information on the suitability of the polymer or the additives added for their film forming function (25). When polymers are used as a binder, adhesive properties in addition to polymer viscosity may be determined. The adhesive property can be evaluated by the measurement of tack or stickiness. This measurement involves determining the force required to detach two platens held together by the polymer solution. Other tests that may be carried out include measurements for surface

activity, glass transition temperature, cloud point, and adhesion strength of dried polymer.

## 6. COMMONLY USED EXCIPIENTS IN GRANULATION

Excipients for granulation can be largely divided into two categories, as bulking agents and as functional additives. It is true that bulking agents or fillers also serve a function in that they form the core or structure of a dosage form. Nevertheless, bulking agents generally differ from the functional additives in that they are usually inert materials that are relatively inexpensive. Functional additives include binders, disintegrants, lubricants, colorants, and stabilizing agents. Besides the pharmacopoeia, several recently published handbooks can provide a compilation of commonly used pharmaceutical excipients (26,27).

The choice of excipients depends on a number of factors, namely, the drug used, the process involved, the formulator, and the cost of excipient. Differences will be seen in the choice of excipients by innovator companies and generic companies as they have different cost considerations. Some granulation processes like fluid bed granulation would require tighter control of drug and excipient specifications compared with wet granulation using a paddle mixer. In fluid bed, besides the control of particle size distribution, particle density of excipient should not be too greatly different from that of the drug. Extrusion–spheronization would generally require microcrystalline cellulose.

A very common filler is lactose, although other sugars, dicalcium phosphate, starch, pregelatinized starch, and microcrystalline cellulose are also used. The starches and microcrystalline cellulose are also disintegrants in tablets. For tablets, other commonly used disintegrants include sodium starch glycolate, croscarmellose, crospovidone, and low-substituted hydroxypropylcellulose. Lubricants are usually not added till prior to filling or tableting of the granules. The most commonly used lubricant is magnesium stearate. Other lubricants used include calcium stearate, stearic acid, wax, hydrogenated vegetable oil, talc, and starch. Much work has been done on lubricants and it is well established that the physical characterization of the lubricant is very important to ensure consistency in functionality, especially when a change is made in the supplier (28).

Binders used in granulation consist of a wide variety of sugars and polymers—natural, semisynthetic, and synthetic. Sugars used include sucrose, glucose, and sorbitol. Examples of natural polymers are acacia, alginic acid, sodium alginate, gelatin, and starch. There is an inherent variability in the natural polymers of different batches and this sometimes gives rise to problems in production. It is essential to characterize binders for their viscous properties, at the least, to minimize potential processing problems. The semisynthetic binders include ethylcellulose, sodium carboxymethylcellulose, methylcellulose, hydroxypropylcellulose, and hydroxypropylmethylcellulose. By comparison with the natural binders, variability between batches of the semisynthetic binders from the same supplier can be expected to be much less. For each polymer type, a number of viscosity grades are available. The two types of synthetic binders in use are polyvinylpyrrolidone and polyethylene glycol. Polyvinylpyrrolidone is widely used in both wet massing and fluid bed granulation. The main application of polyethylene glycol as a binder is in melt granulation.

Other excipients employed in pharmaceutical products include colorants, coating aids, stabilizers, pH modifiers, and release rate modifiers. They play very

important roles and would require specific characterization tests. In the making of a product, the functional excipients to be added must be carefully selected to ensure that the final product is bioavailable and esthetically pleasing. As all raw materials have to undergo a processing schedule for conversion of the materials to the finished product, it is likely that the processing can be very unpredictable if standardizing of raw materials has not been carried out.

## 7. COMPATIBILITY OF DRUG AND EXCIPIENT

In the formulation of any pharmaceutical product, it is imperative to ensure that the ingredients used are compatible with one another. Incompatibilities can occur between drug and excipient as well as between the excipients themselves. Incompatibilities may be manifested through many modes, such as acid–base interaction and complex formation, resulting in lower potency and/or stability and eventually poor therapeutic efficacy of the product. It is therefore essential to avoid incompatibilities and this is achieved by carrying out studies to detect potential interactions between the components used in the formulation.

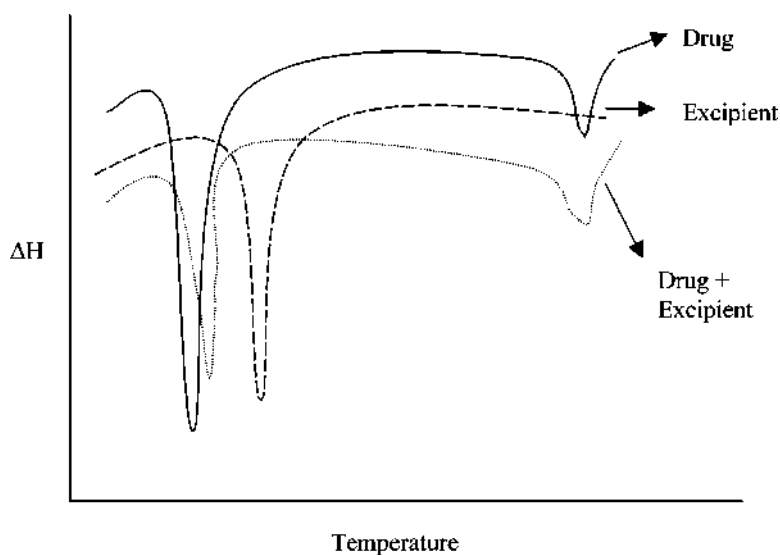
### 7.1. Stability Study

This is the traditional method of detecting incompatibilities. Mixtures of the drug and excipient are prepared and stored under exaggerated conditions of heat, light, and humidity. A detailed discussion on the “realistic” proportions of drug and excipient to be used in the investigation was reported by Akers (29). The mixtures are examined for any physical change and aliquot samples are withdrawn for assay of the intact drug at varying time intervals. Incompatibility is reflected by various signs such as appearance of precipitate and decrease in the concentration of intact drug.

### 7.2. Thermal Analysis

A relatively simple approach for the investigation of potential interaction between a drug and an excipient can be carried out using differential scanning calorimetry. The drug, individual excipients, and binary mixtures of the drug and excipient are separately scanned at a standard rate over a temperature range that encompasses all the thermal features of the drug and excipients. Each mixture consists of 50% drug and excipient in order to maximize the likelihood of an interaction. The thermograms of the mixtures and the appropriate individual components are compared. Interaction is deduced by changes in the thermal features such as elimination or appearance of a peak in the thermogram of the mixture. This is illustrated in [Figure 9](#). Changes in shape, onset, maximum temperature, and relative height of the peaks may also indicate interaction. However, it should be cautioned that these changes could also arise from physical mixing of the components.

A big advantage of differential scanning calorimetry over the traditional stability test is the speed of determination. However, like all methods, differential scanning calorimetry has its own limitations. It is not applicable if the test materials exhibit properties that make data interpretation difficult, such as eutectic formation, coincident melting, and dissolution of one component in the melt of the other. It is not advisable to rely on differential scanning calorimetry alone to determine incompatibility. Chrzanowski et al. (30) reported that differential scanning calorimetry



**Figure 9** Thermograms indicating drug–excipient interaction.

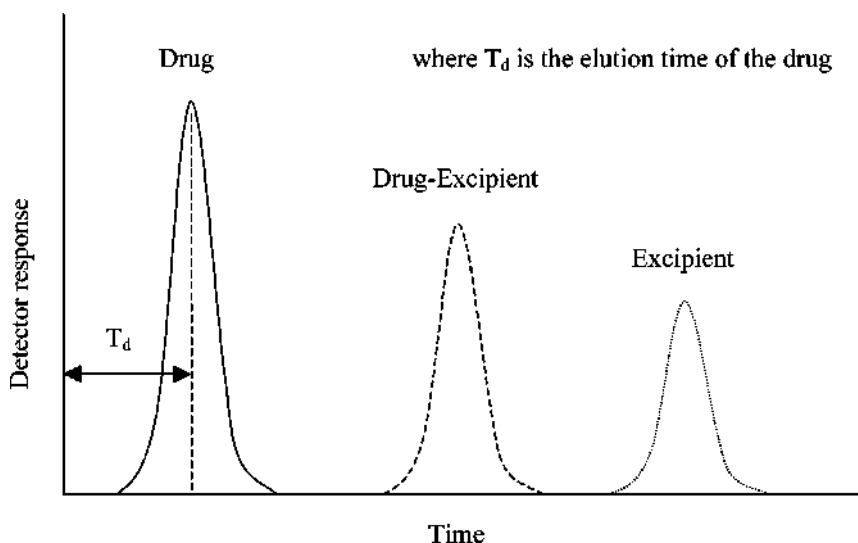
indicated no incompatibilities in mixtures of fenretinide–excipient and mefenidil–excipient, whereas the traditional stability study showed some incompatibilities. Hence, differential scanning calorimetry should only be used to supplement the stability test by eliminating the incompatible excipients and reducing the number of test samples.

### 7.3. Chromatographic Methods

Chromatography was first used for the separation of colored leaf pigments. The operation of chromatography is based on the distribution of a material between a stationary phase and a mobile phase. The stationary phase can be a solid or a liquid supported on a solid while the mobile phase can be a gas or a liquid which flows continuously around the stationary phase. The different components in a mixture can be separated and identified as a result of differences in their affinity for the stationary phase.

In addition to its application in the separation and identification of materials, chromatography is also employed to detect potential interactions between materials. Both thin-layer chromatography and liquid chromatography are commonly employed in this area of study. In thin-layer chromatography, the stationary phase consists of a powder adhered onto a glass, plastic, or metal plate. The powders commonly used are silica, alumina, polyamides, cellulose, and ion-exchange resins. Solutions of the drug, excipient, and drug–excipient mixture are prepared and spotted on the same baseline at one end of the plate. The plate is then placed upright in a closed chamber containing the solvent, which constitutes the mobile phase. As the solvent moves up the plate, it carries with it the materials. Those materials which have a stronger affinity for the stationary phase will move at a slower rate. The material is identified by its  $R_f$  value, which is defined as the ratio of the distance which the material has moved to the distance the solvent front has moved. The position of the material on the plate is indicated by spraying the plate with certain reagents or





**Figure 10** Chromatograms illustrating drug–excipient interaction.

exposing the plate to ultraviolet radiation. If there is no interaction between the drug and excipient, the mixture will produce two spots whose  $R_f$  values are identical with those of the individual drug and excipient. If there is interaction, the complex formed will produce a spot whose  $R_f$  value is different from those of the individual components.

In liquid chromatography, the distribution of the material between the solid stationary phase in a column and the liquid mobile phase is determined. The material is identified by the time taken for it to elute from the column. Solutions of the drug, excipient, and drug–excipient mixture are prepared and injected into the column. The materials will elute from the column at different speeds, depending on their affinity for the column. The concentration of the material that elutes from the column is detected and plotted against time to give to a chromatogram. If there is interaction between the drug and excipient, the complex formed will exhibit an elution time different from those of the individual components. This is illustrated in Figure 10, which shows the chromatograms of the drug, excipient, and drug–excipient mixture plotted together. Similarly, gas chromatography may be used.

## 8. CONCLUSION

The greatest difficulty for any process technologist is to decide on the type and extent of material characterization to be undertaken such that it is cost-effective in the long run. Often, it is the problem from the production run that necessitates further material characterization to be carried out either for the purpose of resolving the problem or to prevent future occurrences. This chapter serves to identify the more common material characterization methods that can be carried out and the potentially useful information that can be inferred from the tests. It is hoped that the discussion of the many methods of material characterization could help in the choice of characterization methods for material testing.

## REFERENCES

1. Heywood H. The evaluation of powders. *J Pharm Pharmac* 1963 (suppl 15):56T.
2. Wadell H. Volume, shape and roundness of rock particles. *J Geol* 1932; 40:443.
3. Stanley-Wood NG. Particle characterisation by size, shape and surface for individual particles. Stanley-Wood NG, ed. *Enlargement and Compaction of Particulate Solids*. London: Butterworths, 1983:18.
4. Kaye BH. Multifractal description of ragged fine particle profile. *Particle Char* 1984; 1:14.
5. Kaye BH. Specification on the ruggedness and/or texture of a fine powder profile by its fractal dimension. *Powder Technol* 1978; 21:1.
6. Flook AG. The use of dilation logic on the Quantimet to achieve dimension characterisation of textured and structured profiles. *Powder Technol* 1978; 21:295.
7. Meakin P. Simulations of aggregation processes. Avnir D, ed. *The Fractal Approach to Heterogeneous Chemistry*. Chichester: Wiley, 1990:131–160.
8. Allen T. *Particle Size Measurement*. 4th ed. London: Chapman and Hall, 1990.
9. Svarosky L. Characterization of powders. Rhodes MJ, ed. *Principles of Powder Technology*. Chichester: John Wiley, 1990:35.
10. Washington C. *Particle Size Analysis in Pharmaceuticals and Other Industries*. U.K: Ellis Horwood, 1992.
11. British Standard 3406, Part 4, 1963.
12. Timbrell V. A method of measuring and grading microscopic spherical particles. *Nature* 1952; 170:318.
13. Russ JC. *Computer-Assisted Microscopy*. New York: Plenum Press, 1990.
14. Sing KSW. Adsorption methods for surface area determinations. Stanley-Wood NG, Lines RW, eds. *Particle Size Analysis*. Cambridge, U.K: The Royal Society of Chemistry, 1992:13.
15. Lowell S, Shields JE. *Particle Surface Area and Porosity*. 2nd ed. London: Chapman and Hall, 1983:205.
16. Buckley HE. *Crystal Growth*. New York: Wiley, 1951:29.
17. Haleblan J, McCrone W. Pharmaceutical applications of polymorphism. *J Pharm Sci* 1969; 58:911.
18. Li ZG, Harlow RL, Foris CM, Li H, Ma P, Vickery RD, Maurin MB, Toby BH. Polymorph determination for the GP IIb/IIIa antagonist, roxifiban, using a combination of electron diffraction and synchrotron x-ray powder diffraction techniques. *J Pharm Sci* 1999; 88(3):297.
19. Bottom R. The role of modulated temperature differential scanning calorimetry in the characterization of a drug molecule exhibiting polymorphic and glass forming tendencies. *Int J Pharm* 1999; 192:47.
20. Taylor LS, Zografi G. The quantitative analysis of crystallinity using FT-Raman spectroscopy. *Pharm Res* 1988; 15(5):755.
21. Findlay WP, Bugay DE. Utilization of Fourier transform-Raman spectroscopy for the study of pharmaceutical crystal forms. *J Pharm Biomed Anal* 1998; 16:921.
22. Yamashiro M, Yuasa Y, Kawakita K. An experimental study on the relationships between compressibility, fluidity and cohesion of powder solids at small tapping numbers. *Powder Technol* 1983; 34:225.
23. Kostelnik MC, Beddow JK. New techniques for tap density. In: Hausner HH, ed. *Modern Developments in Powder Metallurgy IV, Processes*. Proceedings of the 1970 International Powder Metallurgy Conference. New York: Plenum Press, 1970.
24. Watt PR. *Tablet Machine Instrumentation in Pharmaceuticals: Principles and Practice*. Chichester: Ellis Horwood, 1988.
25. Okhamafe AO, York P. Interaction phenomena in pharmaceutical film coatings and testing methods. *Int J Pharm* 1987; 39:1.

26. Handbook of Pharmaceutical Excipients. Washington, DC: American Pharmaceutical Association, London: Pharmaceutical Society of Great Britain, 1986.
27. Brittain HG, ed. Analytical Profiles of Drug Substances and Excipients. San Diego: Academic Press, 1993.
28. Chowhan ZT. Excipients and their functionality in drug product development. Pharm Tech 1993; 17:72.
29. Akers MJ. Preformulation testing of solid oral dosage form drugs. Can J Pharm 1976; 11:1.
30. Chrzanowski FA, Ulissi LA, Fegely BJ, Newman AC. Preformulation excipient compatibility testing. Application of differential scanning calorimetric method versus a wet granulation simulating isothermal stress method. Drug Dev Ind Pharm 1986; 12:703.

# 4

## Binders and Solvents

**Ehab Hamed, Derek Moe, and Raj Khankari**

*CIMA Labs Inc., Eden Prairie, Minnesota, U.S.A.*

**John Hontz**

*Biovail, Chantilly, Virginia, U.S.A.*

### 1. INTRODUCTION

Binders are adhesives that are added to solid dosage formulations. The primary role of binders is to provide the cohesiveness essential for the bonding of the solid particles under compaction to form a tablet. In a wet-granulation process, binders promote size enlargement to produce granules and thus improve flowability of the blend during the manufacturing process. Binders may also improve the hardness of the tablets by enhancing intragranular as well as intergranular forces. In a direct compression process, binders often act as fillers and impart compressibility to the powder blend. The cohesive properties of binders may reduce friability of the tablets and thus aid in their durability and elegance. Although the purpose of using binders in a tablet formulation is not to influence its disintegration and dissolution rate, these properties may be modified due to the altered wettability of the formulation.

### 2. TYPES OF BINDERS

Binders are usually natural polymers, synthetic polymers, or sugars. The selection of the type of binder for a particular system is quite often empirical and dependent on the previous experience of the formulator, in conjunction with examination of excipient compatibility studies. Selection of the quantity of binder required in a particular system can be determined by optimization studies, using parameters such as granule friability, tablet friability, hardness, disintegration time, and the drug dissolution rate. Some commonly used binders in wet granulation with their usual concentration range, along with the granulating system are listed in [Table 1](#). Basic properties of some widely used binders with their method of incorporation will be discussed in this section (1–4).

**Table 1** Commonly Used Granulating Systems

Binder	Method of incorporation	Percentage used in formula	Solvent	Percentage used in granulating system
Natural polymers				
Starch	Wet mixing	2–5	Water	5–25
Pregelatinized starch	Wet mixing	2–5	Water	10–15
	Dry mixing	5–10	Water	
Gelatin	Wet mixing	1–3	Water	5–10
Acacia	Wet mixing	3–5	Water	10–15
Alginic acid	Dry mixing	1–5	Water	
Sodium alginate	Wet mixing	1–3	Water	3–5
Synthetic polymers				
PVP	Wet mixing	0.5–5	Water or hydroalcoholic solution	5–10
	Dry mixing	5–10		
Methyl cellulose	Wet mixing	1–5	Water	2–15
	Dry mixing	5–10		
HPMC	Wet mixing	2–5	Water or hydroalcoholic solution	5–10
	Dry mixing	5–10		
Na-CMC	Wet mixing	1–5	Water	5–15
	Dry mixing	5–10		
Ethyl cellulose	Wet mixing	1–5	Ethanol	2–10
	Dry mixing	5–10		
Sugars				
Glucose	Wet mixing	2–25	Water	25–50
Sucrose	Wet mixing	2–25	Water	50–67
Sorbitol	Wet mixing	2–10	Water	2–25

Source: Modified from Ref. 3.

## 2.1. Natural Polymers

### 2.1.1. Starch

Starch is a polymeric carbohydrate obtained from various plant sources, such as potato, wheat, maize, rice, and tapioca. It is a GRAS-listed material and traditionally was one of the most widely used tablet binders. It is insoluble in cold water and in alcohol but it gelatinizes in hot water to form a paste. Starch paste can be prepared by dispersing starch in 1–1.5 parts of cold water for initial wetting followed by addition of two to four times as much boiling water with continuous stirring until a translucent paste is obtained. This paste is further diluted by cold water to the desired concentration. Alternatively, starch paste can also be prepared by heating the cold water suspension of starch to boiling in a steam-jacketed kettle with constant stirring.

Freshly prepared starch paste is used at a concentration of 5–25% (w/w) in a tablet granulation. Relatively soft and friable granules are produced when starch paste is used as a binder. Consequently, it yields tablets that disintegrate readily. During the wet-massing process, high viscosity of the starch paste can sometime make it difficult to evenly distribute the binder in the powder blend.

### 2.1.2. *Pregelatinized Starch*

Pregelatinized starch is a modified starch used in tablet formulations as a binder, diluent, and disintegrant. It is obtained by chemically and mechanically processing the starch to rupture all or part of the starch granules. This process renders starch flowable, directly compressible, and soluble in warm water without boiling. As a binder in a wet-granulation process, pregelatinized starch can be used either as a solution reconstituted in water or as a dry blending followed by wetting with water. The latter process requires two to four times more binder to achieve the same binding effect.

Pregelatinized starch is available in fully or partially pregelatinized forms. The degree of pregelatinization determines its solubility in cold water. Cold-water soluble fraction for a partially pregelatinized starch is 10–20%. Starch 1500 is partially pregelatinized starch containing 20% maximum cold-water soluble fraction, which makes it useful for wet granulation. The water-soluble fraction acts as a binder, while the remaining fraction facilitates the tablet disintegration process.

### 2.1.3. *Gelatin*

Gelatin is a mixture of purified protein fractions obtained by partial acid hydrolysis (Type A gelatin) or alkali hydrolysis (Type B gelatin) of animal collagens. It is insoluble in cold water and in alcohol, but is soluble in hot water. In hot water, gelatin forms a gel on cooling to 35–40°C. At temperatures >40°C, the system exists as a solution. Therefore, the gelatin solutions must be used when warm to avoid gel formation.

During the preparation of gelatin solution, gelatin must be wetted in cold water and then heated with gentle agitation to ensure dissolution. The agitation intensity must be kept low to prevent air entrapment in the viscous solution. Use of gelatin as a binder is limited in general-purpose tablets because it produces tablets characterized by high hardness and slow disintegration. However, these properties of gelatin along with its smooth mouth feel can prove to be advantageous in a lozenge formulation.

Gelatin reacts with aldehydes, aldehydic sugars, anionic and cationic polymers, electrolytes, metal ions, plasticizers, preservatives, and surfactants. In a wet-granulation process of a formulation containing color, the migration of dyes toward the upper surface of the static bed during the drying operation is often amplified by the presence of gelatin due to its high affinity for dyes. The gelatin solutions are susceptible to microbial contamination upon storage, therefore freshly prepared solutions should be used.

### 2.1.4. *Acacia*

Acacia is a natural gum obtained from the acacia trees. It is a complex, loose aggregate of sugars and hemicelluloses. It is commercially available in a powdered form, a granular form, or as a spray-dried product. As a tablet binder, it is used in an aqueous solution or added in dried form prior to moistening with water. Acacia forms very hard tablets, which disintegrate slowly. Aqueous solutions are susceptible to bacterial and enzymatic degradation. It is incompatible with amidopyrine, cresol, phenol, ethanol, ferric salts, and a number of other substances. Acacia, which was widely used in the past as a tablet binder, is rarely used today, in favor of one of the many synthetic polymers.

### 2.1.5. *Tragacanth*

Tragacanth is a naturally occurring dried gum. It poses similar problems as those of acacia. Dry addition to the blend followed by addition of water works better than addition of the solution, because it is difficult to prepare and use the mucilage.

### 2.1.6. *Alginic Acid*

Alginic acid is a polymannuronic acid extracted from seaweed. It is used as a binder and disintegrating agent at concentrations between 1% and 5%. It slowly hydrolyzes at room temperature and is insoluble in water. Therefore, it is best incorporated in a dry state. It is incompatible with strong oxidizing agents. It forms insoluble alginates with the alkaline earth metals and group III metals, with the exception of magnesium. These alginates may delay disintegration of the tablets due to their gelling properties.

### 2.1.7. *Sodium Alginate*

Sodium alginate slowly dissolves in water to form a viscous solution. A 3–5% solution typically is used in wet-granulation processes. It has also been used in sustained release formulations because it delays the dissolution of a drug from tablets. It is hygroscopic and its aqueous solution is susceptible to microbial contamination.

## 2.2. Synthetic Polymers

### 2.2.1. *Polyvinylpyrrolidone (Povidone)*

Polyvinylpyrrolidone (PVP) is versatile and one of the most commonly used binders. It is readily soluble in water and freely soluble in alcohol and many other organic solvents. It is available in a variety of grades of different molecular weights. PVP is generally used in the form of a solution; however, it can be added to the blends in the dry form and then granulated in situ. It is frequently used as a binder in effervescent and chewable tablets because the tablets manufactured using PVP as a binder generally harden with age. Aqueous or hydroalcoholic solutions of PVP are used to granulate insoluble materials and alcoholic solutions are used for granulating soluble materials. It is used as a binder at concentrations between 0.5% and 5%. Low- to medium-viscosity grades are preferred since the high-viscosity grades of PVP have been known to cause dissolution problems. It is highly hygroscopic and picks up significant amounts of moisture at low relative humidities and can deliquesce at high relative humidities.

### 2.2.2. *Methyl Cellulose*

Methyl cellulose (MC) is a long-chain substituted cellulose in which  $\approx 27$ –32% of the hydroxyl groups are in the form of methyl ether. It is available in a variety of grades of different degrees of substitution and average molecular weight. Therefore, it offers considerable latitude in binding strength. Efficiency of MC as a binder improves with increasing molecular weight. Low- or medium-viscosity grades are preferred when used as a binder. It may be added as a dry powder or as a solution. Although an aqueous solution of 1–5% can be used to granulate soluble or insoluble excipients, it is a better binder for soluble excipients such as lactose and mannitol. MC produces granulations that compress easily. Granulation produced using 5% MC solution is equivalent in hardness to 10% starch paste. It produces robust tablets with moderate hardness, which does not increase with age.

MC is practically insoluble in hot water, ethanol, chloroform, ether, and saturated salt solutions. In cold water, it swells and disperses slowly to form a clear to opalescent, viscous dispersion. To produce an aqueous solution, the appropriate quantity of MC powder is suspended in 25% of the required amount of water at

80°C. The remaining amount of water is added cold, or ice water is added to the hot slurry with vigorous stirring in order to cool it down to 20°C. A clear aqueous solution of MC is obtained. MC can also be mixed as a dry powder with another powder prior to mixing with cold water or may be moistened with an organic solvent such as 95% ethanol prior to the addition of water.

### 2.2.3. *Hydroxypropyl Methyl Cellulose (Hypromellose)*

Hydroxypropyl methyl cellulose (HPMC) is a propyleneglycol ether of MC. HPMC is available in a variety of viscosity grades. Its binding properties are comparable to those of MC. Concentrations of 2–5% (w/w) may be used as a binder in either wet- or dry-granulation processes. HPMC is soluble in cold water and forms a viscous colloidal solution. To prepare an aqueous solution, HPMC is first hydrated in 20–30% of required water at 80–90°C with vigorous stirring. Cold water is added to produce the required volume. Hydroalcoholic solutions or mixtures of water and other water-miscible solvents such as glycol can also be used to dissolve HPMC. HPMC is first dispersed in the organic solvent, at a ratio of five to eight parts of solvent to one part of HPMC. Cold water is then added to produce the required volume. HPMC is incompatible with some oxidizing agents.

### 2.2.4. *Sodium Carboxymethyl Cellulose*

Sodium carboxymethyl cellulose (Na-CMC) is a sodium salt of carboxymethyl ethers of cellulose. It is available in a variety of molecular weights which influence the viscosity of the solution and its swelling properties. It easily disperses in water at all temperatures to form a clear colloidal solution. Its aqueous solubility varies with its degree of substitution, which is the average number of hydroxyl groups substituted per anhydroglucose unit. A 5–15% solution may be used for the granulation of soluble as well as insoluble powders. The granulations produced using Na-CMC as a binder are softer, but have good compressibility. It forms tough tablets of moderate hardness. Na-CMC is a highly hygroscopic material. It can adsorb a large quantity (>50%) of water at high relative humidities. Therefore, the tablets using Na-CMC as a binder have a tendency to harden with age. Na-CMC is incompatible with strongly acidic solutions and with metal salts of iron, aluminum, zinc, etc.

### 2.2.5. *Ethyl Cellulose*

Ethyl cellulose, an ethyl ether of cellulose, is available in a variety of grades, which differ in their viscosity. Low-viscosity grades are used as binders in concentrations of 2–10% in ethanol. Ethyl cellulose produces softer granules, which compress into tablets that easily disintegrate. However, the dissolution of the active ingredient from these tablets may be slower because ethyl cellulose is insoluble in water. Ethyl cellulose may be used in a dry form or in an ethanolic solution for wet granulation. Ethyl cellulose is a good nonaqueous binder for water sensitive formulations.

### 2.2.6. *Polyethylene Glycol*

Polyethylene glycols (PEGs), by themselves, have limited binding action; however, they can enhance the effectiveness of tablet binders and impart plasticity to granules. They can also be used in thermoplastic granulations. In this process, a powder blend containing 10–15% (w/w) of PEG-6000 is heated to 70–75°C to obtain a paste-like



mass, which forms granules if stirred while cooling. This technique is used in lozenge formulations.

### 2.2.7. *Polymethacrylates (Eudragit)*

Polymethacrylates (Eudragit NE 30D and Eudragit RS 30D) can be used as binders in aqueous or nonaqueous wet-granulation processes. They are supplied as 30% aqueous dispersions. Dilution with water prior to use is recommended. Eudragit RS 30D is incompatible with magnesium stearate.

### 2.2.8. *Polyvinyl Alcohol*

Polyvinyl alcohols (PVAs) are available in a variety of viscosity grades. Viscosity ranges from 10 to 100 cps lend themselves for tablet granulations. PVAs are water-soluble polymers. They form softer granulations, which yield tablets that do not harden with age.

## 2.3. Sugars

### 2.3.1. *Glucose (Dextrose)*

Glucose, when applied as a syrup in concentrations  $>50\%$  in wet-granulation processes, exhibits good bonding properties. It produces moderately strong granules and tablets, which are hard and brittle. Glucose is also used as a direct compression tablet diluent and binder, primarily in chewable tablets. Anhydrous dextrose adsorbs significant amounts of moisture at  $25^{\circ}\text{C}$  and 85% relative humidity to form a monohydrate. The monohydrate also absorbs moisture at 85% relative humidity. Dextrose is a reducing sugar and in its aldehyde form, can react with amines, amides, amino acids, etc. Brown coloration may occur in tablets containing dextrose and strong alkali or amines.

### 2.3.2. *Sucrose*

Sucrose is commercially available in several forms such as granular, fine granular, fine, superfine, and confectioners sugar. The confectioners sugar is most commonly used in wet-granulation formulations. Sucrose syrup, containing 50–67% (w/w) sucrose, is used as a binder in wet-granulation processes. It can also be used as a dry binder where it is granulated with water or hydroalcoholic solutions. Like glucose, sucrose produces strong, but hard and brittle tablets. The amount of binder determines the tablet hardness. Softer granules can be obtained by using hydroalcoholic mixtures as granulating solutions. Finely divided sugar is hygroscopic. Tablets containing large amounts of sucrose may harden with age, which may result in slower disintegration. In systems where quick overwetting occurs, the amount and the rate of addition of the sucrose syrup must be carefully monitored. Use of sucrose with starch paste may improve the tablet quality. Sucrose is incompatible with aluminum. It hydrolyses in the presence of acids. Contamination of powdered sucrose with heavy metals may lead to incompatibility with substances such as ascorbic acid.

### 2.3.3. *Sorbitol*

Sorbitol is an optical isomer of mannitol. It is highly hygroscopic at relative humidities of 65% and above. Therefore, it used as a humectant in pharmaceutical formulations.

Whenever this property of sorbitol as a moisture control agent is desirable, it can be used as a binder. Up to 2–20% of sorbitol can be added as 10–25% aqueous solution in wet-granulation formulations.

## 2.4. New Binders

Recently, several new natural and synthetic binders have been investigated for potential applications in pharmaceutical formulations. Nearly all the natural binders investigated were gums obtained from different plant origins, including Khaya gum (5), *Leucaena leucocephala* seed gum (6), *Anacardium occidentale* gum (7), Gellan gum (8), and a combination of detarium gum and veegum (9). While some of these materials have been approved by the U.S. FDA for use as food additives, the issues of compendial requirements, lack of literature support, and potential reproducibility problems associated with materials obtained from plant origin can limit their applicability in the pharmaceutical industry. New synthetic binders that have been investigated include maltrodextrins (10) and chitosan derivatives (11).

## 3. FACTORS INFLUENCING BINDER EFFICIENCY

The function of binders in a tablet formulation is to impart strength and to reduce the friability of granules and tablets. Several factors influence the effectiveness of a binder in a formulation. Some of these factors are related to the drug and other excipients in the formulation and others are related to the binder and solvent system used. Storage conditions as well as granulation process parameters can also significantly affect the binder efficiency.

### 3.1. Properties of the Drug and Other Excipients in the Formulation

#### 3.1.1. Particle Size

The primary particle size of the drug or excipients can affect granule strength, porosity, and consolidation rate during high-shear granulation. Smaller particles with higher surface areas have more contact points to allow the formation of stronger granules than larger particles when granulated with enough binder (12,13). However, because of the greater surface area, the solvent and binder requirements increase as the primary particle size decreases (14–16). Therefore, to better anticipate the effect of reducing the excipients' primary particle size on granule properties, the degree of liquid saturation and binder level must be considered. At the same binder and solvent level, excipients with larger particle sizes consolidate easier and produce less porous granules as compared to finer particles (17,18).

Another factor that can be related to the excipients' primary particle size is the distribution of drug through different size granules. When the drug particles were smaller than the filler, larger granule size fractions exhibited the highest drug content and when the drug particles were larger, the highest drug concentration was found in the smallest granule size fraction (12). The results can be explained in terms of the ability of small drug particles to form stronger granules that resist breakdown during high-shear granulation and grow to a further extent than those formed primarily by larger filler particles.

### 3.1.2. Solubility

The solubility of drugs and other excipients in the granulating solvent can significantly affect the granules' properties. Increasing the excipients' solubilities in the granulating solvent decreased the solvent requirement and led to the formation of granules of tighter particle size distribution and reduced friability (19,20). Accordingly, lactose-based granules are formed at a lower degree of water saturation compared to insoluble fillers such as dicalcium phosphate (21,22) and calcium hydrogen phosphate (23). The findings can be attributed to the increased plasticity of the moist lactose agglomerates owing to its solubility in water, which increased the propensity for particle coalescence and growth during high-shear granulation processes. Holm et al. (24) described lactose granulation as less sensitive to moisture content and kneading intensity than calcium hydrogen phosphate.

Changing the formulation proportions of water-soluble excipients can dramatically alter the granules' properties. The addition of microcrystalline cellulose to a lactose-based formulation increased the solvent requirement and produced larger granules for both PVP and gelatin-based granulations (25). Increasing the starch content in a lactose:starch-based formulation leads to the formation of smaller granules with a wider particle size distribution (26). The results were explained in terms of water absorption by starch particles and the formation of weaker granules that could not grow in size to the same extent as when starch was absent (27).

Drug solubility in the granulating solvent can affect its distribution in different granule size fractions. Drugs with high solubility in the granulating solvent have a higher tendency to migrate during drying creating a drug-rich crust. Abrasion during subsequent milling leads to the formation of highly concentrated fines relative to larger granules (13).

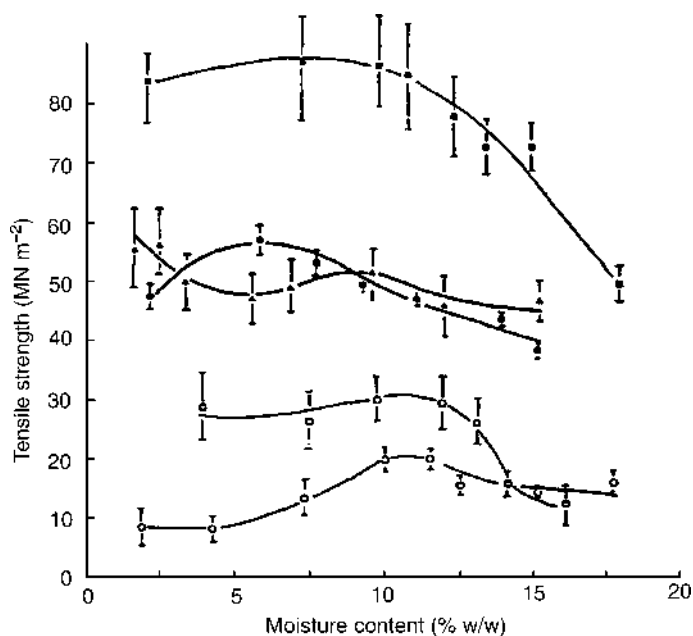
## 3.2. Properties Related to the Binder and Solvent System

### 3.2.1. Mechanical Properties of the Binder

The mechanical and film-forming properties of a binder determine the strength and deformation behavior of a binder matrix. These properties of the binder matrix primarily determine the effectiveness of the binder. The tensile strengths of the films of acacia, gelatin, methylhydroxyethyl cellulose, PVP, and starch prepared with varying moisture levels by equilibration at different relative humidities were reported (28). [Figure 1](#) shows the effect of moisture content on the tensile strength of the binders mentioned earlier. The results show that acacia and PVP form weak films while gelatin films possess the highest tensile strength. PVP was also reported to exhibit low values of Young's modulus showing that it is the most deformable binder (28). This high deformability of PVP aids in consolidation during compaction. Consequently, PVP is considered the most preferred wet binder by many (29).

### 3.2.2. Binder–Substrate Interactions

As mentioned earlier, significant determinants of the granule and tablet strength are wettability of the substrate by the binder solution, binder cohesion, and binder–substrate adhesion (30). Rowe (31–33), in a series of publications, presented theoretical approaches to predict the binder–substrate interactions. According to Rowe, dense nonfriable granules are expected when the spreading coefficient of binder over substrate is positive while negative spreading coefficient leads to the formation of porous granules (31). For a low-polarity substrate, such as griseofulvin, either



**Figure 1** The effect of moisture content on the tensile strength of binder films. ■, gelatin; ▲, methylhydroxyethylcellulose; ●, starch; □, acacia; ○, PVP. The vertical bars show the limits of error of the means at  $P = 0.95$ . (From Ref. 28.)

PVP or starch would be the optimal binder while for high-polarity substrates, such as theophylline, acacia or HPMC would be the optimal binder (31). PVP and HPMC were reported to have positive spreading coefficient over lactose, acyclovir, and pentoxifylline with the latter having the highest spreading coefficient and acyclovir having the lowest spreading coefficient (34). When granulated in fluid bed with both binders, pentoxifylline produced the least friable granules followed by lactose and then Acyclovir. The results also showed that PVP is more efficient than HPMC due to the lower work of cohesion and adhesion of the latter (34). This approach is based solely on the hypothesis that optimum spreading of the binder is the main criterion for successful formulation. It does not take into account other equally important factors, such as disintegration, dissolution, and flow properties. However, the studies show the potential of using the theoretical approach in binder selection and formulation optimization.

PVP-based granulation of detergent-cleaned hydrophilic glass beads produced larger granules with more crushing resistance and lower friability than those of dimethylsilane surface treated hydrophobic glass beads (35). The results can be attributed to the better adhesion of PVP to hydrophilic surfaces.

### 3.2.3. Binder Solution Viscosity and Surface Tension

To better understand the importance of binder solution viscosity and surface tension, the mechanism of granule formation must be considered. When two particles collide during granulation, they either coalesce or spring back from each other. It is the balance of the kinetic energy of the colliding particles against the other forces acting to bring the particles together that decides the outcome of the collision process

(36,37). The forces that help dissipate the collision energy and keep the colliding particles together include the static pendular bridge (surface tension effect), viscous and interparticle friction forces (17).

Increasing binder solution viscosity increased the granule size and decreased the amount of binder required to initiate granule growth in both high-shear (37) and fluid-bed (36) granulation processes. However, when the binder solution viscosity is very high, problems with binder spreading and distribution arise. The highest binder solution viscosity that can be used depends on the excipients and drug properties and the processing parameters, such as the ability of existing pump and/or spray systems to handle viscous liquids. Experiments in high-shear granulators with initial binder solution viscosities exceeding 100 mPa.s have been reported (38).

When different molecular weights of PVP and HPMC were dissolved in water, reductions in surface tension were observed (39). The decrease in surface tension was higher for HPMC but independent of the concentrations of both binders and inversely dependent on the molecular weight of PVP (39). Decreasing binder solution surface tension decreased the capillary suction pressure and decreased the friction resistance to consolidation and, therefore, increased the granule consolidation rate, but also increased the minimal attainable granule porosity, i.e., granules consolidated fast but not as far (18). Decreasing the binder solution surface tension was also reported to decrease the liquid requirement to attain overwetting (40).

#### 3.2.4. Solvent Properties

Granule properties can be significantly affected by changing the granulating solvent. The effect stems from the change in excipient solubility and wettability, as well as the mechanism of granule consolidation. In the pharmaceutical industry, only aqueous, hydroethanolic, and ethanolic solvent systems are widely used. Lactose granulations prepared using ethanolic PVP solution had higher porosity and friability compared to those prepared using water as a granulating solvent (41). For hydroethanolic solvent systems, increasing the ethanol content has been shown to increase tablet strength (41). The results were attributed to the increased fragmentation tendency of granules when ethanol contents were increased (42). Changing the solvent system can affect the formulation excipients' wettability and influence binder distribution. For example, PVP distribution in low-shear granulation process improved when water was replaced with a hydroalcoholic solution (43).

### 3.3. Storage Conditions

Storage conditions can severely alter the tablet properties through their effect on the binder's physical characteristics. For example, the hardness and disintegration time of Ranitidine tablets prepared using the PVP wet granulation method decreased when the tablets were stored under elevated moisture levels (44). PVP can absorb a significant quantity of water when exposed to elevated humidity, which decreases the polymer glass transition temperature (45,46). PVP is proposed to stay in a glassy state at room temperature at a relative humidity  $\leq 55\%$  and completely convert to the rubbery state at room temperature at a relative humidity  $>75\%$  (45). Such changes in the physical state of a binder can dramatically change a tablet's hardness, friability, disintegration, and drug release. Moreover, the presence of other additives in the formulation can augment the plasticizing effect of moisture and cause the granule and tablet properties to change at a lower moisture level than those used in accelerated stability protocols.

HPC was reported not to have a glass transition temperature, but rather melt at a temperature of 190–195°C (46). When compared to PVP, tablets prepared using HPC maintained its dissolution profile after storage for 24 weeks under different moisture/temperature conditions while those prepared using PVP showed a reduction in pyridazine release when stored at 40°C/75% relative humidity (46).

## 4. PROCESSING PARAMETERS FOR COMMONLY USED BINDERS

### 4.1. Polyvinylpyrrolidone

#### 4.1.1. High-Shear Granulation

The granulation process in high-shear equipment is influenced by a score of variables including impeller speed, amount of binder and granulating solvent, liquid addition rate, wet massing time, method of binder incorporation (wet vs. dry), method of solution addition (dripping vs. atomization), equipment design, and chopper speed. These parameters influence the binder performance through their combined effects on the binder distribution/dissolution, the degree of saturation, and the extent to which granules are allowed to grow and densify before they are broken down by the high-speed chopper.

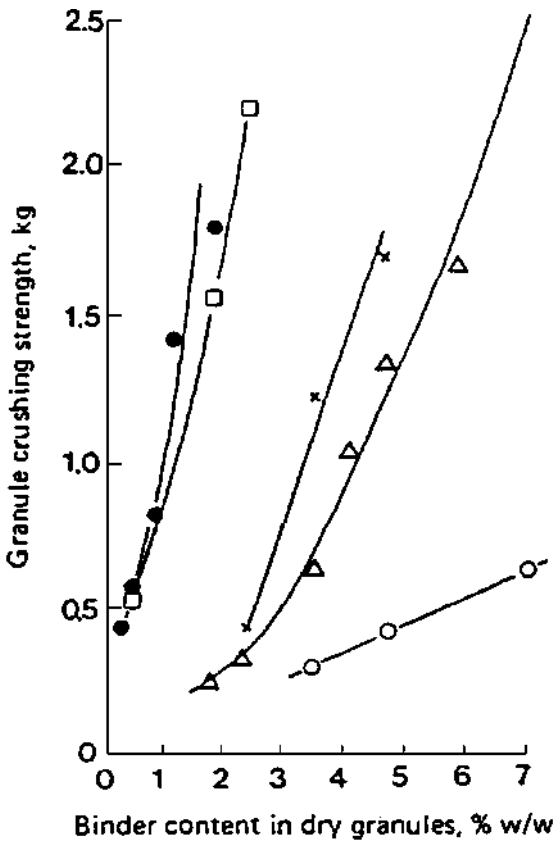
**4.1.1.1. Impeller Speed.** Impeller speed is the most significant parameter affecting the binder performance in high-shear granulation. Increasing the impeller speed in PVP and PVP–PVA copolymer-based formulations increases the granule size (21,22,47–49) and the bulk and tapped density (21,49), but decreases the percent fines (47,49) and the granule porosity (21,49). However, the effect of impeller speed on binder performance is dependent on the degree of solvent saturation, the binder amount, the stage at which the impeller speed is varied (liquid addition vs. wet massing), and the properties of the formulation materials. At a low degree of solvent saturation or with an insufficient amount of binder, the effect of increasing impeller speed is in favor of breaking up the weak nuclei/agglomerates and hindering any further granule growth (26,50).

**4.1.1.2. PVP Concentration.** Figure 2 shows a plot of crushing strength of dicalcium phosphate granules vs. binder concentration for PVP in comparison to other binders (51).

As the binder concentration increases, the crushing strength of the granules increases. The plot also shows that starch and gelatin can produce much stronger granules with lower concentrations compared to acacia, PVP, or PEG 4000 (51). As expected, the particle size of granules also increases as the binder concentration increases. Figure 3 shows a plot of mean particle size of lactose granules vs. binder concentration (25).

The intragranular bonds formed during granule drying that contribute to the tablet strength include cohesion of binder film and binder substrate adhesion. Jarosz and Parrott (52) showed that the radial and axial tensile strengths of dicalcium phosphate tablets increased with increasing concentrations of PVP in the formulation (Fig. 4).

High molecular weight PVP produces larger calcium hydrogen phosphate granules than hydrolyzed gelatin and low-viscosity HPMC (38). When compared to PVP, gelatin-based granules start growing at a lower degree of liquid saturation and the dependence of granule size on binder concentration was more prominent (38). Cutt et al.(53) compared glass ballotini granules prepared using PVP, hydrolyzed gelatin, and HPMC. PVP produced the least friable granules at lower concentrations and

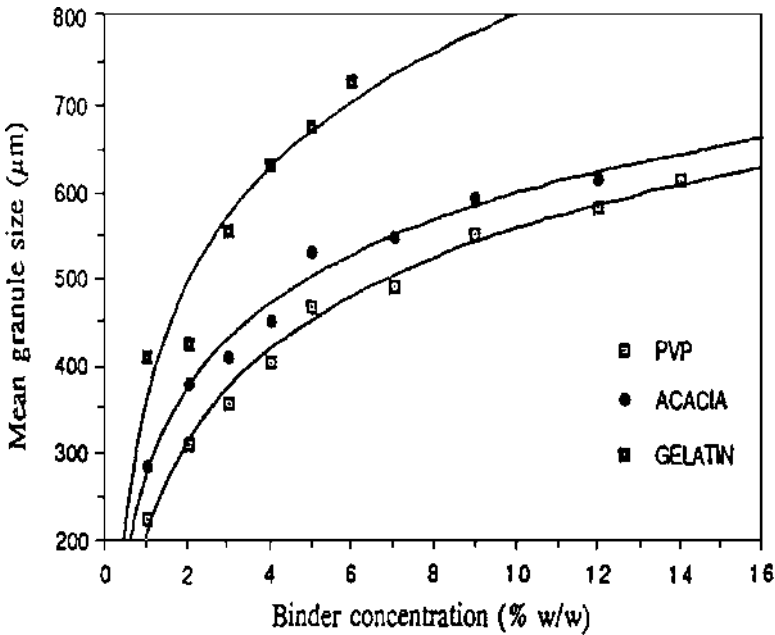


**Figure 2** Crushing strength of wet granulated dicalcium phosphate. Binders: ●, gelatin; □, potato starch mucilage; ×, acacia; Δ, povidone; and ○, PEG 4000. (From Ref. 51.)

HPMC produced the most friable and smallest granules owing to its lower work of adhesion and cohesion (53). Gelatin produced the strongest granules that needed more work to compress due to their higher resistance to deformation (53).

**4.1.1.3. Liquid Addition Rate and Wet Massing.** Liquid addition rate can significantly influence binder distribution and granular uniformity. Lower water addition rate improves PVP–PVA copolymer distribution and reduces the liquid requirement to obtain an acceptable granulation (26,54). Hydroalcoholic and alcoholic solutions can behave differently due to heat generation and faster evaporation in high-shear mixers. The effect of liquid addition rate is dependent on the solubility of the formulation excipients in the solvent used. Slower PVP solution addition rate enhances granule growth and decreases porosity of the insoluble dicalcium phosphate granulations (21); lactose-based formulations, on the other hand, are less sensitive to liquid addition rate (22,49). Increasing the wet massing time of PVP-based formulations increases granules size and density, while decreasing the percentage of fines and granule porosity (16,21,49,54).

**4.1.1.4. Method of Binder Incorporation.** PVP can be incorporated in the granulation either by dry or by wet addition methods. The method of binder incorporation affects the granule's properties through its effect on binder dissolution and



**Figure 3** Plot of the mean granule size as a function of binder concentration for the granulation of lactose. (From Ref. 25.)

distribution. However, given the good hydration and high solubility in combination with the use of high impeller and chopper speed, PVP is usually uniformly distributed when incorporated by either method using water, hydroalcoholic, or alcoholic solvents. Nevertheless, a higher PVP level may be needed with the dry addition method to obtain similar granulation results.

#### 4.1.2. Fluid-Bed Granulation

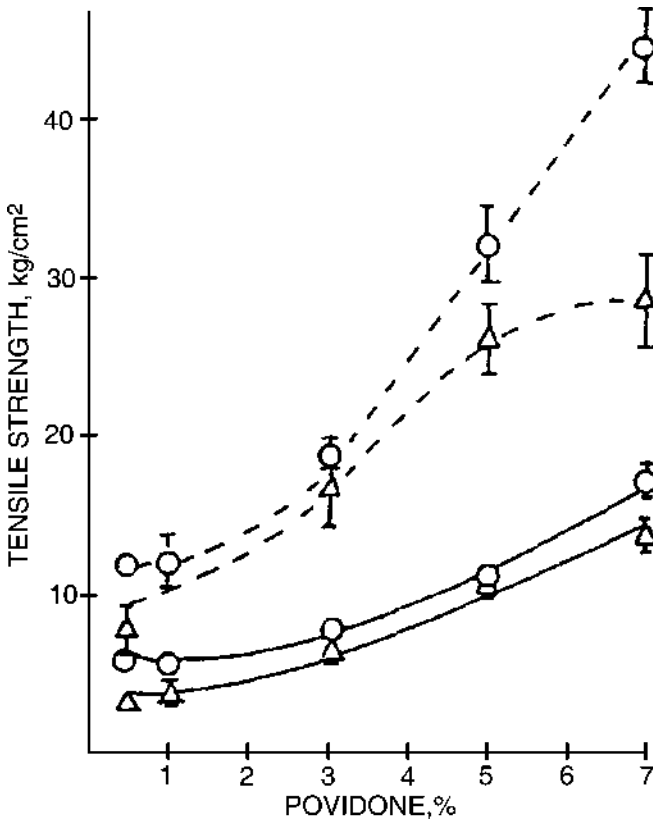
**4.1.2.1. PVP Concentration and Molecular Weight.** Binder solution concentration is one of the most crucial parameters controlling granule properties in fluid-bed granulations. Increasing PVP concentration increases the granule size, narrows the granule size distribution, and improves granule flowability and strength (55,56). The increase in granule size can be related to the increase in binder solution viscosity with a subsequent increase in droplet size together with an increase in the force binding the particles at the higher binder concentration.

However, granule size enlargement with increasing PVP level reaches a plateau at a critical PVP concentration (25,34). Increasing the PVP level beyond this critical concentration does not lead to further growth of granules but rather widens the size distribution and decreases the friability of the granules (25).

#### 4.1.3. Roller Compaction

**4.1.3.1. PVP Concentration.** The effect of binder concentration on the properties of granules and tablets prepared by roller compaction is dependent on other processing parameters including feed rate, roll pressure, and speed. Increasing the binder level increases tablet hardness and decreases their friability due to the





**Figure 4** The influence of povidone on the tensile strength of tablets of dibasic calcium phosphate dihydrate compressed at 2268 kg (—) and at 4536 kg (- - - -). Δ, axial; ○, radial. (From Ref. 52.)

imparted plasticity of the formed granules (57). However, at high binder level, increasing the roll pressure increases the tablet friability and decreases the tablet's hardness due to the formation of less friable granules with higher fragmentation resistance during compression (25). When the PVP level was reduced to 1%, the granules properties were dependent on the drug properties (58). Increasing the roll pressure in this case had no effect on tablet hardness or friability. However, increasing the roll and feed rate can lead to a slight decrease in tablet friability (58).

#### 4.1.4. Extrusion/Spheronization

Several processing factors can affect the binder performance during extrusion and spheronization processes including hydration level, extruder speed, shape, hole size, spheronizer speed, and residence time. While the use of microcrystalline cellulose alone or in combination with lactose is widely adopted, the addition of binders can aid in the formation of a plastic mass than can be easily extruded and spheronized. Increasing the PVP or starch/gelatin level increases the pellet size and decreases their friability (59).

When microcrystalline cellulose was spray dried with PVP, HPC, HPMC, Na-CMC, and pregelatinized starch, the properties of the produced pellets were improved in terms of yield, sphericity, and surface smoothness (60). PVP and HPC were described as superior to other binders in terms of water requirements, process sensitivity, and yield (60).

## 4.2. Cellulosic Polymers

### 4.2.1. High-Shear Granulation

**4.2.1.1. Polymer Concentration.** The effect of cellulosic polymer concentration on granule properties is dependent on their method of addition. In the wet addition method, increasing the concentration of HPC, different viscosity grades of HPMC and MC in lactose–cornstarch–microcrystalline cellulose systems increases the percentage of binder-rich oversize granules (61). The effect can be attributed to the increase in binder solution viscosity and heterogenous binder distribution.

In the dry addition method, the effect of increasing polymer concentration on a granule's properties depends on the nature of the polymer and its molecular weight/viscosity. Increasing the concentration of HPC and low-viscosity HPMC (3 cP) increases the median granule size (61). Increasing the concentration of medium- and relatively high-viscosity HPMC (6 and 15 cP) and MC is accompanied by a slight decrease in granule median size and increase in the percentage of oversized granules (61). The different behavior can be related to the extent and rate of binder dissolution as well as binder adhesiveness at different degrees of hydration.

### 4.2.2. Fluid-Bed Granulation

**4.2.2.1. Polymer Concentration.** Similar to a high-shear granulation process, the effect of increasing HPMC and HPC concentrations on granule properties is dependent on their method of addition in fluid-bed granulation. The polymers are more uniformly distributed when added by the wet addition method and the granule size and strength increase with increasing the polymer concentrations (62,63). In the dry addition method, HPMC is more concentrated in the larger granules and the granule size is independent of the concentration of HPMC (62,64). Agitating the fluid bed, however, showed no difference in HPMC and HPC distributions between the wet and dry addition methods (65). In general, HPC produced stronger granules than HPMC when added in the dry state since it maintains its flexibility and adhesiveness at low moisture content, which allows more binding during drying (65). Increasing the level of MC, on the other hand, is not accompanied by an increase in granule size or strength when it is included by both dry and wet addition methods (65). MC has the lowest thermal gelation temperature and thus it loses its adhesiveness at the low moisture level applied in fluid-bed granulation.

## 4.3. Gelatin

Gelatin was one of the most commonly used binders during the 1960s and 1970s. Recently, the use of gelatin in pharmaceutical formulations has significantly reduced. Many factors contributed to the lower popularity of gelatin including its high

binding ability and the resultant slow tablet disintegration, and perhaps most importantly, the introduction of new semisynthetic binders whose methods of preparation are easier and exhibited better reproducibility and reliability than gelatin.

In gelatin-based formulations, granule properties are highly sensitive to the level of gelatin used (54,66). Gelatin produces stronger granules than CMC, PEG (67,68), MC (69), acacia, and PVP (25) due to the high tensile strength of the gelatin film compared to other binders. In fluid-bed granulation processes, increasing the gelatin concentration increases the granular size up to a certain critical concentration beyond which the granule size becomes independent of gelatin concentration (25).

The granulation method can affect the properties of granules and tablets prepared using gelatin through their effect on gelatin distribution within the granules. Acetaminophen granules and tablets prepared by wet massing, roller compaction, and spray drying of the substrate-binder slurry were compared (70–72). Wet massing produced a sponge-like binder matrix embedding substrate particles while the roller compaction produced a distribution of discrete binder particles in the substrate particles. Spray drying coated the granules with an outer shell of the binder and produced superior tablets when compared to wet massing and roller compaction (70–72).

#### 4.4. Starch

Despite the reproducibility problems associated with a variety of starch sources and the method of paste formation, starch paste is still a relatively popular binding agent in the pharmaceutical industry owing to its superior compatibility with many drugs. The granule properties are greatly affected by the method of starch paste preparation, in particular the gelatinization temperature. Starches obtained from different sources start gelatinization at different temperatures (corn starch starts at 75°C and potato starch starts at 60°C) and yield pastes with different concentration gradient viscosities (73). Increasing the temperature at which starch is gelatinized increases the degree of gelatinization with a subsequent increase in tablet hardness (73). Variability in ascorbic acid tablet properties decreases when starch paste was prepared and pumped under precise temperature control (74).

Starch paste concentration can also affect granule properties. When compared with diluted paste (5%, w/w) with good fluidity, a concentrated paste (15%, w/w) with high viscosity produced lactose granules with a sharper particle size distribution when using a high-shear mixer (75). Nevertheless, high impeller speed and longer processing time was needed for deaggregation and a better distribution of the concentrated starch paste. However, diluted starch paste produced stronger granules, better compressibility, and longer disintegration time (76).

Starch can also be used as a disintegrant owing to its wicking and swelling properties. Starch paste by itself is not sufficient to introduce effective disintegration and a disintegrant, starch or other, is usually recommended to enhance the effect of the starch introduced as a paste. When the quantity of disintegrant starch exceeds that of paste starch, the disintegration time decreases as the compression force increases. When paste starch is used in higher quantity than dry, the disintegration time increases with compression force. The effect can be related to different disintegration mechanisms introduced by disintegrant and starch pastes (77).

When starch is dextrinized by the addition of  $\alpha$ -amylase, the resultant paste produces stronger granules with better flowability that produce tablets with shorter disintegration time, lower friability, and less variability in weight and hardness.

However, excessive dextrinization leads to the formation of paste with lower adhesive and tackiness properties and poor binding capabilities (78). Starch can be also modified through pregelatinization or cross-linking. Cross-linking does not improve the granulation ability of conventional starch. When compared to conventional and cross-linked starches, pregelatinized starch yields coarser granules with lower friability (79).

## REFERENCES

1. Wade A, Walker PJ, eds. *Handbook of Pharmaceutical Excipients*. 2nd ed. London: The Pharmaceutical Press, 1994.
2. Lieberman HA, Lachman L, Schwartz JB, eds. *Pharmaceutical Dosage Forms: Tablets*. Vol. 1. 2nd ed. New York: Marcel Dekker, Inc., 1989.
3. Kristensen HG. Binders. *Encycl Pharm Technol* 1993; 451–465.
4. Mendes RW, Roy SB. Tableting excipients, part II. *Pharm Tech* 1978; 3:61–74.
5. Odeku OA, Itiola OA. Evaluation of Khaya gum as a binder in a paracetamol tablet formulation. *Pharm Pharmacol Commun* 1998; 4:183–188.
6. Deodhar UP, Paradkar AR, Purohit, AP. Preliminary evaluation of leucaena leucocephala seed gum as a tablet binder. *Drug Dev Ind Pharm* 1998; 24(6):577–582.
7. Chukwunweike Onukwo G, Okoye J. Evaluation of anacardium occidentale gum as a binder in lactose based tablet formulations. *Bole Chim Farm* 1997; 136:569–574.
8. Antony PJ, Sanghavi NM. A new binder for pharmaceutical dosage forms. *Drug Dev Ind Pharm* 1997; 23(4):417–418.
9. Attama AA, Adikwu MU, Esimone CO. Binary combination of detarium gum and vee-gum as a binder in sodium salicylate tablets. *Bole Chim Farm* 1999; 138:199–202.
10. Soyeux P, Delacourte A, Delie B, Lefevre P, Boniface B. Influence of optimization of operating parameters with a new binder in wet granulation. I: use in powder form. *Eur J Pharm Biopharm* 1998; 46:95–103.
11. Aiedeh KM, Taha MO. Synthesis of chitosan triethylene glycol phthalate and its evaluation as a binder in wet granulation procedures. *Die Pharmazie* 1999; 54:614–619.
12. Vromans H, Poels-Janssen HGM, Egermann H. Effect of high shear granulation on granulate homogeneity. *Pharm Dev Technol* 1999; 4:297–303.
13. Van den Dries K, Vromans H. Relationship between inhomogeneity phenomenon and granule growth mechanisms in a high-shear mixer. *Int J Pharm* 2002; 247:167–177.
14. Paris L, Stamm A. Optimal massing liquid volume determination by energy consumption measurement: study of the influence of some physical properties of solvent and products used. *Drug Dev Ind Pharm* 1985; 11(2,3):361–386.
15. Tapper GI, Lindberg NO. Granulation of some lactose qualities with different particle size distributions in a domestic type mixer. *Acta Pharm Suec* 1986; 23:47–56.
16. Schaefer T, Holm P, Kristensen HG. Wet granulation in laboratory scale high shear mixer. *Pharm Ind* 1990; 52(9):1147–1153.
17. Iveson SM, Lister JD, Ennis BJ. Fundamental studies of granule consolidation part 2: effects of binder content and binder viscosity. *Powder Technol* 1996; 88:15–20.
18. Iveson SM, Lister JD. Fundamental studies of granule consolidation part 2: quantifying the effects of particles and binder properties. *Powder Technol* 1998; 99:243–250.
19. Wells JI, Walker CV. The influence of granulating fluids upon granule and tablet properties: the role of secondary binding. *Int J Pharm* 1983; 15:97.
20. Dias VH, Pinto JF. Identification of the most relevant factors that affect and reflect the quality of granules by application of canonical analysis. *J Pharm Sci* 2002; 91(1):273–281.
21. Schaefer T, Holm P, Kristensen HG. Comparison between granule growth in a horizontal and a vertical high speed mixer. I. Granulation of dicalcium phosphate. *Arch Pharm Chem Sci Ed* 1984; 14:1–16.

22. Schaefer T, Holm P, Kristensen HG. Comparison between granule growth in a horizontal and a vertical high speed mixer. II. Granulation of lactose. *Arch Pharm Chem Sci Ed* 1986; 14:17–29.
23. Kristensen HG, Holm P, Jaegerskou A, Schaefer T. Granulation in high speed mixers. Part 4: effect of liquid saturation on the agglomeration. *Pharm Ind* 1984; 46(7):763–767.
24. Holm P, Jaegerskou A, Schaefer T, Kristensen HG. Granulation in high speed mixers. Part 1: effect of process variables during kneading. *Pharm Ind* 1983; 45(8):806–811.
25. Rohera BD, Zahir A. Granulations in a fluidized-bed: effect of binders and their concentrations on granule growth and modeling the relationship between granules size and binder concentration. *Drug Dev Ind Pharm* 1993; 19(7):773–792.
26. Holm P, Schaefer T, Larsen C. End point detection in a wet granulation process. *Pharm Dev Technol* 2001; 6(2):181–192.
27. Holm P. Effect of impeller and chopper design on granulation in a high speed mixer. *Drug Dev Ind Pharm* 1987; 13(9–11):1675–1701.
28. Healey JNC, Rubinstein MH, Walter V. The mechanical properties of some binders used in tableting. *J Pharm Pharmac* 1974; (suppl 26):41.
29. Shangraw RF, Demarest DA Jr. A survey of current industrial practices in the formulation and manufacture of tablets and capsules. *Pharm Tech* 1993; 17:32.
30. Readind SJ, Spring MS. The effects of binder film characteristics on granule and tablet properties. *J Pharm Pharmac* 1984; 36:421–424.
31. Rowe RC. Binder–substrate interactions in granulation: a theoretical approach based on surface free energy and polarity. *Int J Pharm* 1989; 52:149–154.
32. Rowe RC. Surface free energy and polarity effects in the granulation of a model system. *Int J Pharm* 1989; 53:75–81.
33. Rowe RC. Polar/non-polar interactions in the granulation of organic substrates with polymer binding agents. *Int J Pharm* 1989; 56:117–122.
34. Planinsek O, Pisek R, Trojak A, Srcic S. The utilization of surface free-energy parameters for the selection of a suitable binder in fluidized bed granulation. *Int J Pharm* 2000; 207:77–88.
35. Cutt T, Fell JT, Rue PJ, Spring MS. Granulation and compaction of a model system. I. Granule properties. *Int J Pharm* 1986; 33:81–87.
36. Ennis BJ, Tardos G, Pfeffer R. A microlevel-based characterization of granulation phenomena. *Powder Technol* 1991; 65:257–272.
37. Hoornaert F, Wauters PAL, Meesters GMH, Pratsinis SE, Scarlett B. Agglomeration behavior of powders in a lodige mixer granulator. *Powder Technol* 1998; 96:116–128.
38. Ritala M, Jungersen O, Holm P, Schaefer T, Kristensen HG. A comparison between binder in the wet phase of granulation in a high shear mixer. *Drug Dev Ind Pharm* 1986; 12(11–13):1685–1700.
39. Parker MD, York P, Row RC. Binder–substrate interaction in wet granulation. 2: the effect of binder molecular weight. *Int J Pharm* 1991; 72:243–249.
40. Pepin X, Blanchon S, Couarraze G. Power consumption profiles in high-shear granulation. I: liquid distribution in relation to powder and binder properties. *J Pharm Sci* 2001; 90(3):322–331.
41. Wikberg M, Alderborn G. Compression characteristics of granule materials. VII. The effect of intragranular binder distribution on the compactibility of some lactose granulations. *Pharm Res* 1993; 10(1):88–94.
42. Alderborn G. Granule properties of importance to tableting. *Acta Pharm Suec* 1988; 25:229–238.
43. Shah NH, Railkar AS, Phuapradit W, Zeng FW, Chen A, Infeld MH, Malick W. Effect of processing techniques in controlling the release rate and mechanical strength of hydroxypropyl methylcellulose based hydrogel matrices. *Eur J Pharm Biopharm* 1996; 42(3): 183–187.

44. Uzunarslan K, Akbuga J. The effect of moisture on the physical characteristics of ranitidine hydrochloride tablets prepared by different binders and techniques. *Drug Dev Ind Pharm* 1991; 17(8):1067–1081.
45. Kiekens F, Zelko R, Remon JP. Effect of the storage conditions on the tensile strength of tablets in relation to the enthalpy relaxation of the binder. *Pharm Res* 2000; 17(4): 490–493.
46. Fitzpatrick S, McCabe JF, Petts CR, Booth SW. Effect of moisture on polyvinylpyrrolidone in accelerated stability testing. *Int J Pharm* 2002; 246:143–151.
47. Lindberg NO, Jönsson C. The granulation of lactose and starch in a recording high-speed mixer, Diosna P25. *Drug Dev Ind Pharm* 1985; 11(2,3):387–403.
48. Vojnovic D, Chicco D, El Zenary H. Doehlert experimental design applied to optimization and quality control of a granulation process in a high shear mixer. *Int J Pharm* 1996; 145:203–213.
49. Badawy SIF, Menning MM, Gorko MA, Gilbert DL. Effect of process parameters on compressibility of granulation manufactured in high-shear mixer. *Int J Pharm* 2000; 198:51–61.
50. Vojnovic D, Selenati P, Rubessa F, Moneghini M. Wet granulation in a small scale high shear mixer. *Drug Dev Ind Pharm* 1992; 18(9):961–972.
51. Armstrong NA, March GA. *J Pharm Sci* 1976; 65:200.
52. Jarosz PJ, Parrott EL. Factors influencing axial and radial strength of tablets. *J Pharm Sci* 1982; 71:607–610.
53. Cutt T, Fell JT, Rue PJ, Spring MS. Granulation and compaction of a model system. III. Compaction properties of the granules. *Int J Pharm* 1989; 49:157–161.
54. Lindberg NO, Jonsson C. Granulation of lactose in a recording high-speed mixer, Diosna P25. *Drug Dev Ind Pharm* 1983; 9(6):959–970.
55. Aulton M, Banks M. The factors affecting fluidized bed granulation. *Manuf Chem Aeros News* December 1978.
56. Wan LSC, Heng PWS, Ling BL. Fluidized bed granulation with PVP K90 and PVP K120. *Drug Dev Ind Pharm* 1995; 21(7):857–862.
57. Sheskey PJ, Dasbach TP. Evaluation of various polymers as dry binders in the preparation of an immediate-release tablet formulation by roller compaction. *Pharm Tech* 1995:98–112.
58. Murray M, Laohavichien A, Habib W, Sakr A. Effect of process variables on roller-compacted ibuprofen tablets. *Pharm Ind* 1998; 60(3):257–262.
59. Varshosaz J, Kennedy RA, Gipps EM. Effect of binder level and granulating liquid on phenylbutazone pellets prepared by extrusion–spheronization. *Drug Dev Ind Pharm* 1997; 23(6):611–618.
60. Law MFL, Deasy PB. Use of hydrophilic polymers with microcrystalline cellulose to improve extrusion–spheronization. *Eur J Pharm Biopharm* 1998; 45:57–65.
61. Kokubo H, Nakamura S, Sunada H. Effect of several cellulosic binders on particle size distribution of granules prepared by a high-speed mixer. *Chem Pharm Bull* 1993; 41(12):2151–2155.
62. Kokubo H, Nakamura S, Sunada H. Effect of several cellulosic binders on particle size distribution in fluidized bed granulation. *Chem Pharm Bull* 1995; 43(8): 1402–1406.
63. Xu, G, Sunada H, Zhang R. Indomethacin controlled release matrix tablet prepared by wet granulation procedure. *Chem Pharm Bull* 1997; 45(1):214–216.
64. Dasbach T, Sheskey P, Caswell O. Evaluation of the Use of Methocel in Fluid Bed Granulation as a Dry Binder. *Dow Product Information Publications*, 2002.
65. Kokubo H, Nakamura S, Sunada H. Effect of several cellulosic binders and method of their addition on the properties and binder distribution of granules prepared in an agitating fluidized bed. *Chem Pharm Bull* 1998; 46(3):488–493.
66. Nagykaldi VA, Gyarmati L. Untersuchungen zur feuchtgranulation im diosna-mscher V 25. *Pharm Ind* 1980; 42(5):526–531.

67. Solvang S, Finholt P. Effect of tablet processing and formulation factors on dissolution rate of the active ingredient in human gastric juice. *J Pharm Sci* 1970; 59(1):49–52.
68. El-Gindy NA, Smaha MW, El-Marandy HA. Evaluation of binder activities on the physical properties and compression characteristics of granules prepared by two different modes. *Drug Dev Ind Pharm* 1988; 14(7):977–1005.
69. Schaefer T, Worts O. Control of fluidized bed granulation. IV. Effect of binder solution and atomization on granule size and size distribution. *Arch Pharm Chem Sci Ed* 1978; 6:14–25.
70. Seager H, Burt I, Ryder J, Rue PJ, Murray S, Beal N, Warrack JK. *Int J Pharm Tech Prod Manuf* 1998; 1:36.
71. Seager H, Rue PJ, Burt I, Ryder J, Warrack JK. *Int J Pharm Tech Prod Manuf* 1981; 2:41.
72. Rue PJ, Seager H, Ryder J, Burt I. *Int J Pharm Tech Prod Manuf* 1980; 1:2.
73. Makino T, Kitamori N. Importance of gelatinization degree of starch paste binder in hardness and disintegration of tablets. *Chem Pharm Bull* 1995; 43(3):514–516.
74. Makino T, Wada N, Kitamori N. Preparation temperature in fluidized-bed granulation on resultant tablet properties. *Chem Pharm Bull* 1995; 43(3):473–475.
75. Makino T, Kitamori N. Effect of starch paste concentration on particle size distribution of fine granules produced by agitation granulation. *Chem Pharm Bull* 1995; 43(7):1231–1233.
76. Hill PM. Effect of compression force and corn starch on tablet disintegration time. *J Pharm Sci* 1975; 65(11):1694–1696.
77. Hill PM. Starch paste granulation: binder dilution effects on granulations and tablets. *J Pharm Sci* 1976; 65(2):313–314.
78. Bandyopadhyay AK, Chaudhuri B, Bhattacharjee PK. Starch paste granulation I: effect of dextrinized corn starch mucilage as binding agent on granulation and tablet quality. *Aust J Pharm Sci* 1980; 9(3):85–89.
79. Visavarungroj N, Herman J, Remon JP. Crosslinked starch as binding agent. I. Conventional wet granulations. *Int J Pharm* 1990; 59:73–78.

# 5

## Spray Drying and Pharmaceutical Applications

**Metin Çelik**

*Pharmaceutical Technologies International, Inc., Belle Mead, New Jersey, U.S.A.*

**Susan C. Wendel**

*Elan NanoSystems, King of Prussia, Pennsylvania, U.S.A.*

### 1. INTRODUCTION

Spray drying is one of the oldest forms of drying and one of the few technologies available for the conversion of a liquid, slurry, or low-viscosity paste to a dry solid (free-flowing powder) in one unit operation (1). [Figure 1](#) shows a general spray-drying process schematically. The simplicity and flexibility of the spray-drying process make it ideal for handling a wide variety of pharmaceutical products.

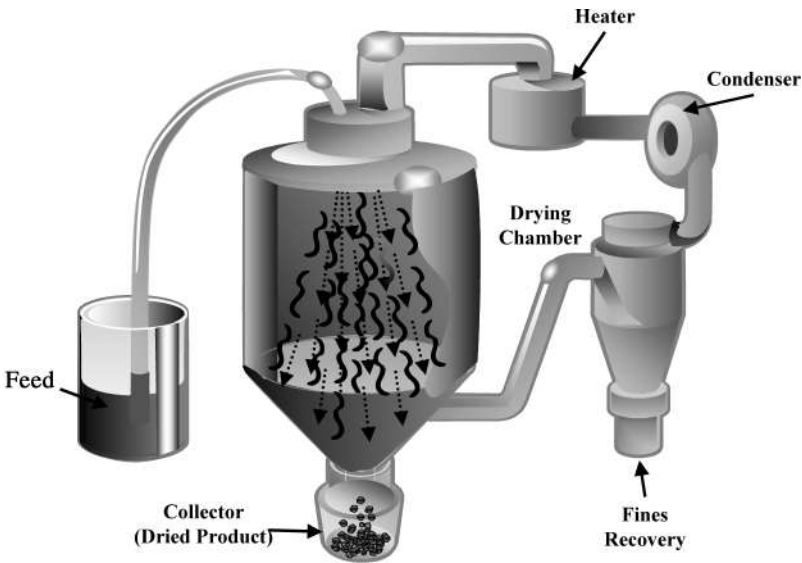
#### 1.1. Background

The first detailed description of the drying of products in spray form was mentioned in a patent of 1872 entitled “Improvement of Drying and Concentration of Liquid Substances by Atomizing” (2). However, this process found its first significant applications in the milk and detergent industries in the 1920’s (3). In current times, spray drying is utilized extensively in many aspects of our daily life from food products, cosmetics, and pharmaceuticals to chemicals, fabrics, and electronics. Typical pharmaceutical examples include spray-dried enzymes (such as amylase, protease, lipase, and trypsin), antibiotics (such as sulfathiazole, streptomycin, penicillin, and tetracycline) and many other active pharmaceutical ingredients, vitamins (such as ascorbic acid and vitamin B12), and excipients for direct compression (such as lactose, mannitol, and microcrystalline cellulose).

#### 1.2. Advantages and Limitations

There are several reasons why the technology of spray drying has found many applications in numerous industries. It is a continuous process. As long as liquid feed can continue to be supplied to the drying system the spray-dried product will continue to be produced. In some instances, this process has been operated for months without interruption. The physical properties of the resulting product (such as particle size





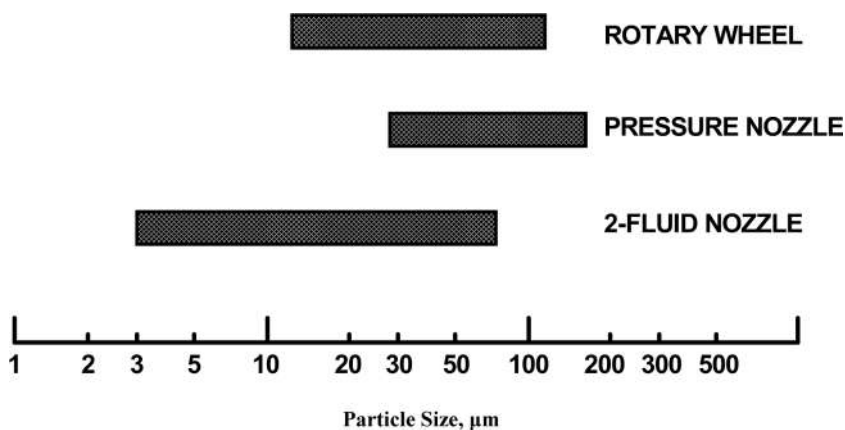
**Figure 1** A schematic representation of a general spray-drying process with primary and secondary product separation.

and shape, moisture content, and flow properties) can be controlled through the selection of equipment choices and the manipulation of process variables. The actual spray-drying process is almost instantaneous as the major portion of the evaporation takes place in as short a time as milliseconds or a few seconds at most, depending on the design of the equipment and process conditions. This makes spray drying well suited for heat-sensitive products. In addition, corrosive and abrasive materials can be readily accommodated because the contact between the mechanical parts and materials is minimal as compared to other granulation processes. Also, spray dryers have few moving parts. In fact, careful selection of various components can result in a system having no moving parts in direct contact with the product. Operation requirements of small and large dryers are the same. This makes spray drying a labor cost-effective process, especially for high-volume products. Last, the spray-drying process can be fully automated. Commercial-scale spray dryers are controlled by programmable logic controllers or solid-state controllers. These control systems monitor exhaust air temperature or humidity and provide an input signal that, by way of a setpoint, modulates the energy supplied to the process (4).

Like all other granulation processes, spray drying also has some limitations. For example, it is not typically well suited for producing granules with mean particle size  $>200\ \mu\text{m}$  as shown in Figure 2. It also has poor thermal efficiency at lower inlet temperatures and the exhaust air stream contains heat, which often requires sophisticated heat exchange equipment for removal.

## 2. SPRAY DRYING PROCESS STAGES

The spray-drying process is carried out in three fundamental stages as shown schematically in Figure 3. The first stage is atomization of a liquid feed into fine



**Figure 2** Range of mean particle sizes achievable by control of atomizer operation at low to medium feed rates.

droplets. In the second stage, spray droplets mix with a heated gas stream and the dried particles are produced by the evaporation of the liquid from the droplets. The final stage involves the separation of the dried powder from the gas stream and collection of these powders in a chamber. The second stage (i.e., the mixing and drying step) has also been considered as separate steps (5). The following sections detail each of these stages, their process parameters, and related equipment details.

## 2.1. Atomization

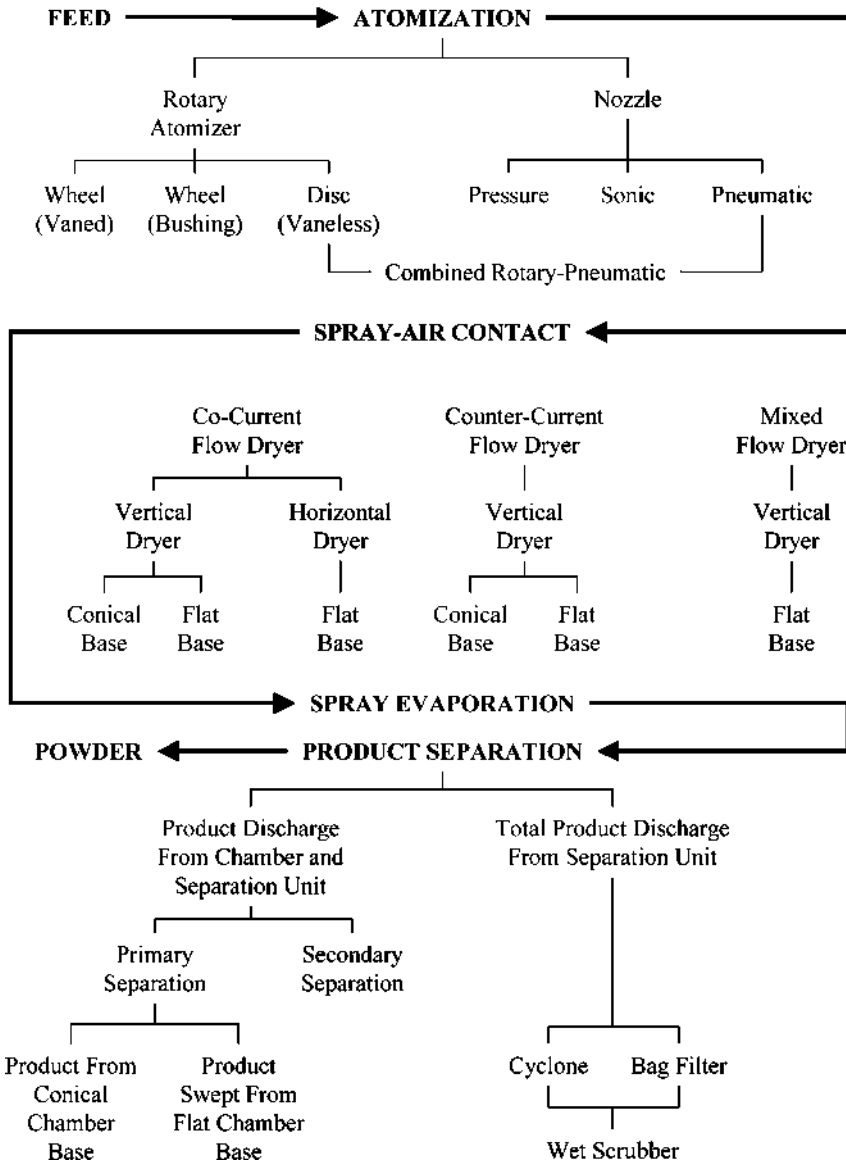
Atomization is the process by which a liquid is disintegrated into many fine droplets. The formation of a spray with high surface/mass ratio is highly critical for optimum liquid evaporation conditions and, consequently, the desired properties of the resulting product. Although ideally the sizes of all droplets should be the same, in practical terms formation of droplets with a narrow size distribution would be satisfactory.

### 2.1.1. Atomizer Types and Designs

Formation of the atomized spray requires application of a force. The commercially available systems employ one of the following in order to create an atomized spray: centrifugal energy, pressure energy, kinetic energy or sonic energy, and vibrations.

**2.1.1.1. Centrifugal Atomizers.** Centrifugal atomizers utilize either a rotating disk or a wheel to disintegrate the liquid stream into droplets (6). Examples of rotary atomizers are shown in [Figure 4](#). These devices form a low-pressure system and a wide variety of spray characteristics can be obtained for a given product through combinations of feed rate, atomizer speed, and atomizer design. The droplet size distribution is fairly narrow for a given method and process conditions but the mean droplet size can be varied from as small as 15  $\mu\text{m}$  to as large as 250  $\mu\text{m}$ , depending on the amount of energy transmitted to the liquid. Larger mean sizes require larger drying chamber diameters. Wheels are well suited for producing sprays in the fine to medium-coarse size range while disks are used to produce coarse sprays.

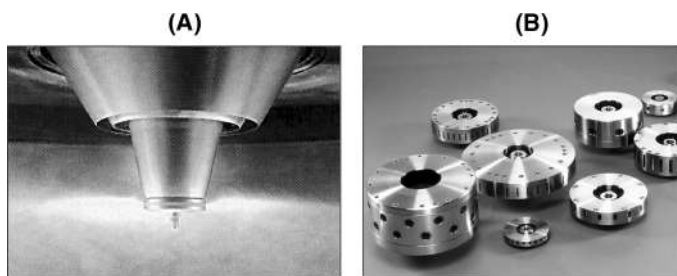
Rotary atomizers normally operate in the range of 5000–25,000 rpm with wheel diameter of 5–50 cm. The mean size of the droplet produced is inversely proportional



**Figure 3** Schematic of spray-drying process shown in stages: stage I: atomization; stage II: spray-air contact and evaporation; stage III: product separation. (From Ref. 5.)

to the wheel speed and directly proportional to the feed rate and its viscosity. Solid content and surface tension are the other factors having minor effects on the droplet size. For example, an increase in feed rate may slightly increase the particle size, but the use of a variable-speed drive on the centrifugal atomizer facilitates correction to the specified size.

Centrifugal atomizer designs include wheels with vanes or bushings and vaneless disks. Vaned atomizer wheels produce sprays of high homogeneity and are the most commonly used as compared to other designs. In this type of atomizer, liquid fed onto a wheel moves across the surface until contained by the rotating vane.



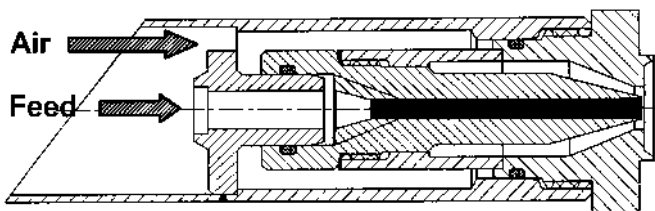
**Figure 4** Common rotary atomizers. (Courtesy of Niro Pharma Systems.)

The liquid flows outward under the influence of centrifugal force and spreads over the vane, wetting the vane surface as a thin film. At very low liquid vane loadings, the thin film can split into streams. No liquid slippage occurs on a wheel once liquid has contacted the vanes. Whether radial or curved, the vanes prevent transverse flow of liquid over the surface. Abrasive materials are best handled using atomizer wheels with bushings. Since the feed material is in direct contact with rotating parts, the bushings feature wear-resistant surfaces and require additional maintenance. Vaneless (disk) designs are often applied when coarse powders are required at high production rates.

Bulk pharmaceutical excipients and fine chemicals, such as antacids, are often produced using centrifugal atomizers. The particles produced by this technique are generally free flowing and, unless intentionally produced with very fine atomization, dust free. The porous structure of the particles provides increased solubility and the relatively low density and friability of these particles result in generally good compaction properties. Also, the batch-to-batch reproducibility and dryer-to-dryer transferability of this technique are excellent. As mentioned earlier, if larger spray-dried particles are desired, larger production drying chambers must be employed.

**2.1.1.2. Kinetic Energy Nozzles.** Kinetic energy is applied in the form of two-fluid or pneumatic atomization. This is the most commonly used atomization technique within the pharmaceutical industry. Here, atomization is accomplished by the interaction of the liquid with a second fluid, usually compressed air. High air velocities are generated within the nozzle for effective feed contact, which breaks up the feed into a spray of fine droplets. Neither the liquid nor the air requires very high pressure, with 200–350 kPa being typical. A typical two-fluid nozzle is shown in Figure 5.

Particle size is controlled by varying the ratio of the compressed airflow to that of the liquid. The main advantage of this type of atomization is that the liquid has a relatively low velocity as it exits the nozzle; therefore, the droplets require a shorter



**Figure 5** Schematic presentation of a typical two-fluid nozzle. (Courtesy of Niro Pharma Systems.)

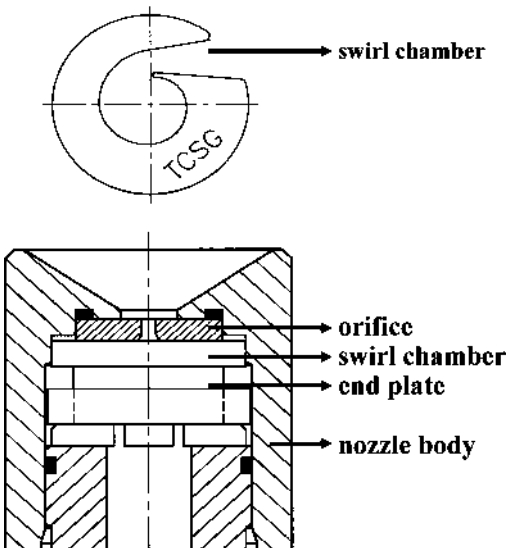
flight path for drying. Because many pharmaceutical applications use relatively small spray dryers, pneumatic nozzles are often used. Another advantage is the simple design that lends itself to easy cleaning, sterile operation, and minimal contamination. Pneumatic nozzles can be designed to meet the most stringent requirements for sterile or aseptic applications. Special consideration must be given to supplying a sterile source of compressed air for atomization.

Another type of kinetic energy nozzle is the three-fluid nozzle. The spray characteristics obtained by two- and three-fluid nozzles are similar when atomizing low-viscosity feeds at up to intermediate feed rates. Use of the second air stream with three-fluid nozzles causes a waste of energy, except for high feed rates of low-viscosity feeds.

**2.1.1.3. Pressure Nozzles.** The second most common form of atomization for pharmaceutical applications is hydraulic pressure nozzle atomization. Here, the feed liquid is pressurized by a pump and forced through a nozzle orifice as a high-speed film that readily disintegrates into fine droplets. The feed is made to rotate within the nozzle, resulting in a cone-shaped spray pattern emerging from the nozzle orifice. Rotary motion within the nozzle can be achieved by use of swirl inserts or spiral grooved inserts (Fig. 6). The swirl inserts have comparatively large flow passages and enable such nozzles to handle high solids feed without causing any wear or clogging.

Because the liquid spray exits the nozzle with a relatively high velocity, a spray-drying chamber at least 2.5 m in diameter and 3.0 m in cylinder height is usually required to operate with pressure nozzles.

The differential pressure across the orifice determines the mean droplet diameter. The distribution about the mean is similar to, but in most cases is narrower



**Pressure Nozzle  
with swirl chamber**

**Figure 6** Schematic presentation of pressure nozzles. (Courtesy of Niro Pharma Systems.)

than, two-fluid atomization. In contrast, sprays from pressure nozzles handling high feed rates are generally wider in distribution and coarser than sprays from vaned wheels. At low feed rates, spray characteristics from nozzles and wheels are comparable. Mean size of spray is directly proportional to the feed rate and inversely proportional to the pressure.

Pressure nozzles are generally used to form coarse spray-dried particles (120–300  $\mu\text{m}$  mean particle size) with good flow properties. Antibiotics are a typical application for such a dryer.

**2.1.1.4. Sonic Energy Atomizers.** The use of sonic energy and vibrations for atomization in spray drying has found growing interest in the last two decades. However, this type of atomizer has not yet found significant commercial applications. The advantages of sonic nozzles operating at low pressure and having wide flow channels suggest that they may be suitable for abrasive and corrosive materials, but it is most likely that sonic nozzles will continue to be developed as atomizers for special applications, such as very fine sprays of mean size 20  $\mu\text{m}$ , where the nature of the spray angle and cone minimizes droplet coalescence (7).

### 2.1.2. Atomizer Selection

The function of any atomizer is to produce as homogenous a spray as possible. The nature of the feed, the characteristics of the spray, and the desired properties of the resulting dried product play very important roles in the selection of the atomizer type. With proper design and operation, nozzles and rotary atomizers can produce sprays having similar droplet size distribution. In all atomizer types, the size of droplets can be altered by either increasing or decreasing the atomization energy (e.g., increased atomization energy results in smaller droplet size). For a given amount of energy, the viscosity and surface tension values of the feed influence the size of the droplet (e.g., higher values result in larger spray droplets).

In general, rotary atomizers are utilized to produce a fine to medium-coarse product with a mean size of 20–150  $\mu\text{m}$  though larger spray-dried particles can also be obtained if a very large drying chamber is used. Nozzle atomizers are used to produce spray-dried product with a coarse mean particle size of 150–300  $\mu\text{m}$  (8).

For a given spray-drying application, the selection between rotary and nozzle atomizers involves the following considerations (9):

1. The feed capacity range of the atomizer for which complete atomization is attained
2. Atomization efficiency
3. The droplet-size distribution at identical feed rates
4. Spray homogeneity
5. Operational flexibility
6. The suitability of dryer chamber design for atomizer operation
7. Feed properties
8. The atomizer experience available for the product in question.

## 2.2. Spray–Air Contact and Evaporation

Once the liquid is atomized, it must be brought into intimate contact with the heated gas for evaporation to take place equally from the surface of all droplets. This contact step takes place within a vessel called the drying chamber. The heated gas is

introduced into the chamber by an air dispenser, which ensures that the gas flows equally to all parts of the chamber.

### 2.2.1. *Spray–Air Contact*

The way in which spray contacts the drying air is a critical factor in spray-drying operations. Spray–air contact is determined by the position of the atomizer in relation to the air inlet.

Inlet air is introduced to the drying chamber via an air disperser, which uses perforated plates, or vaned channels through which the gas is equalized in all directions. It is critical that the air entering the disperser is well mixed and has no temperature gradient across the duct leading into it; otherwise, the drying will not be even within the chamber. The air disperser is normally built into the roof of the drying chamber and the atomization device is placed in or adjacent to the air disperser. Thus, instant and complete mixing of the heated drying gas with the atomized clouds of droplets can be achieved.

Spray droplet movement is classified according to the dryer chamber layout and can be designated as cocurrent, countercurrent, or mixed flow although these designations are not complete representations of the actual conditions.

1. Cocurrent flow is the configuration in which the spray and drying air pass through the dryer in the same direction. This arrangement is widely used and is ideal for heat-sensitive products. Spray evaporation is rapid, the drying air cools accordingly, and overall evaporation times are short. The particles are not subject to heat degradation. In fact, low-temperature conditions are achieved throughout the entire chamber in spite of very hot air entering the chamber.
2. Countercurrent flow is the configuration in which the spray and the air enter at the opposite ends of the dryer. This arrangement has excellent heat utilization. Countercurrent flow is used with nozzle atomization and is well suited for meeting the final spray-dried properties of non-heat-sensitive materials.
3. Mixed flow is the configuration in which both cocurrent and countercurrent flows are incorporated. The advantage of this type of arrangement is that coarse free-flowing products can be produced in relatively small drying chambers. In mixed flow systems the powder is subjected to higher particle temperature. A mixed flow system can be integrated with a fluid-bed drying chamber when lower particle temperatures are necessary.

The spray–air contact design can be selected according to the required particle size and the temperature to which the dried particle can be subjected. For example, if a low product temperature must be maintained at all times, a cocurrent rotary atomizer is selected for producing fine particles while a countercurrent pressure atomizer is preferred for obtaining coarser particles. If coarse particles with predetermined porosity and bulk density properties are desired, a countercurrent pressure nozzle atomizer is well suited as high product temperature can be maintained for obtaining the desired porosity and bulk density of the resulting product. For obtaining coarse spray-dried particles of heat-sensitive materials, a mixed flow nozzle system can be selected. Integration with a fluid bed is recommended for agglomerated or granulated powders.

### 2.2.2. *Drying*

The largest and most obvious part of a spray-drying system is the drying chamber. This vessel can be tall and slender or have a large diameter with a short cylinder height. Selecting these dimensions is based on two process criteria that must be met. First, the vessel must be of adequate volume to provide enough contact time between the atomized cloud and the heated gas. This volume is calculated by determining the mass of air required for evaporation and multiplying by the gas residence time, which testing or experience dictates.

The second criterion is that all droplets must be sufficiently dried before they contact a surface. This is where the vessel shape comes into play. Centrifugal atomizers require larger diameters and shorter cylinder heights. In contrast, nozzle atomizer systems must have narrower and taller drying chambers. Most spray dryer manufacturers can estimate, for a given powder's mean particle size, the dimensions that are needed to prevent wet deposits on the drying chamber walls.

### 2.2.3. *Drying Gas*

In pharmaceutical applications of spray drying, the feedstock can be prepared by suspending or dissolving the product to be spray dried in water. However, the utilization of a wide variety of organic solvents in feedstock preparations is also common. Alcohols, such as ethanol, methanol, and isopropanol are preferred organic solvents in spray drying of pharmaceuticals although other organic solvents such as ketones are also used in other industries; often the synthesis process upstream from the drying step determines the solvent selection. The drying characteristics of the solvents are also important. For example, a solvent with a low boiling point may be the only choice for heat-sensitive materials.

Although evaporating organic solvents by a spray drying process is very efficient due to the resulting shorter residence time, as compared to the evaporation of water, the risk of explosion makes the use of these solvents very hazardous. Therefore, an inert gas, usually nitrogen instead of air, must be used as drying gas for the evaporation of the solvents. Use of inert gas requires the use of a closed-cycle system for spray drying in order to recover the solvent and to limit the gas usage. However, for small drying tests and laboratory work, the nitrogen can be used without recirculation, using a carbon bed on the exhaust gas to collect the solvent.

## 2.3. **Dried Powder Separation**

Powder separation from the drying air follows the drying stage. In almost every case, spray-drying chambers have cone bottoms to facilitate the collection of the dried powder.

Two systems are utilized to collect the dried product. In the first type of system, when coarse powders are to be collected, they are usually discharged directly from the bottom of the cone through a suitable airlock, such as a rotary valve. The gas stream, now cool and containing all of the evaporated moisture, is drawn from the center of the cone above the cone bottom and discharged through a side outlet. In effect, the chamber bottom acts as a cyclone separator. Because of the relatively low efficiency of collection, some fines are always carried with the gas stream. These must be separated in a high-efficiency cyclone followed by a wet scrubber or in a fabric filter (bag collector). Fines collected in the dry state (bag collector) are often added to the larger powder stream or recycled. When very fine powders are being



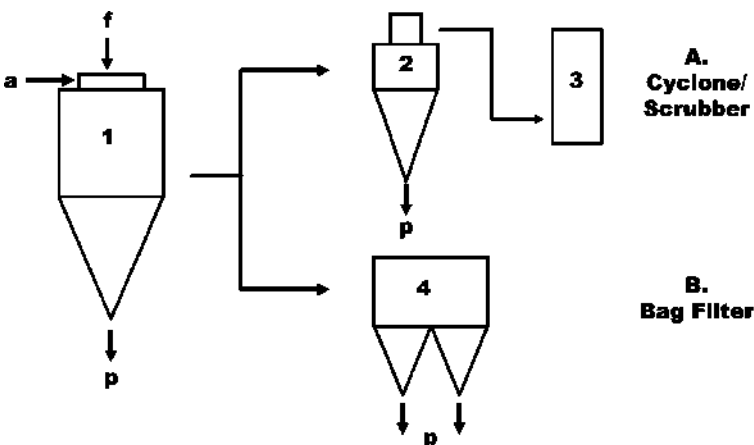
produced, the side outlet is often eliminated and the dried product together with the exhaust gas is transported from the chamber through a gooseneck at the bottom of the cone. The higher loading of entrained powder affects cyclone design but has little or no effect on the bag collector size.

In the second type of system, total recovery of dried products takes place in the separation equipment. This type of system does not need a product-conveying system; therefore, the separation efficiency of the equipment becomes very critical. Separation of dried product from the air influences powder properties by virtue of the mechanical handling involved during the separation stage. Excessive mechanical handling can produce powders with a high percentage of fines.

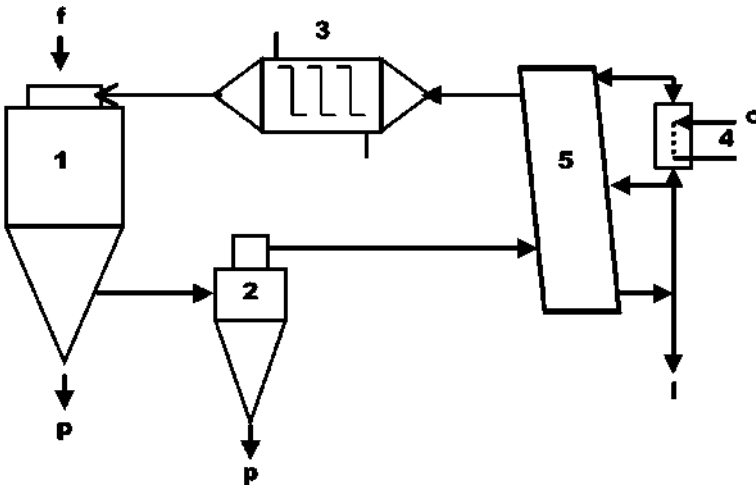
### 3. PROCESS LAYOUTS

The most widely used spray-drying process layout is the open-cycle layout in which the air is drawn from the atmosphere, passed through the drying chamber, and exhausted back to the atmosphere. This layout is used for aqueous feedstock and employs air as the drying gas. There are numerous variations of open-cycle layout systems, two of which are common in pharmaceutical applications (Fig. 7) (10). The most common and cost-effective layout utilizes a high-efficiency cyclone and scrubber (Fig. 7A). In this layout, the loss of very fine particles to the atmosphere cannot be prevented. If the desired particle size of the spray-dried product is too small to be recovered by cyclone and scrubber systems then the use of a layout employing a bag filter is recommended (Fig. 7B).

Closed-cycle layouts are mainly used for nonaqueous (i.e., organic solvents) feedstock and generally require the use of inert gas as the drying medium. They are also employed when flammable, explosive, or toxic products are used in the spray drying process or atmospheric pollution is not permitted. Figure 8 illustrates the flow diagram for a closed-cycle layout schematically (11). These systems require a good control of the scrubbing–condensing stage at precise temperatures.



**Figure 7** Typical layout of the open-cycle spray dryer system: (A) cyclone/scrubber and (B) bag filter. a, air; f, feed; p, spray-dried product. 1, spray dryer chamber; 2, cyclone; 3, wet scrubber; 4, bag filter/collector. (Adapted from Ref. 10.)



**Figure 8** Typical layout of the closed-cycle spray dryer system: c, coolant (diluent); f, feed; l, solvent recovery; p, spray-dried product. 1, dried powder; 2, cyclone; 3, liquid-phase indirect heater; 4, heat exchanger; 5, scrubber–condenser. (Adapted from Ref. 11.)

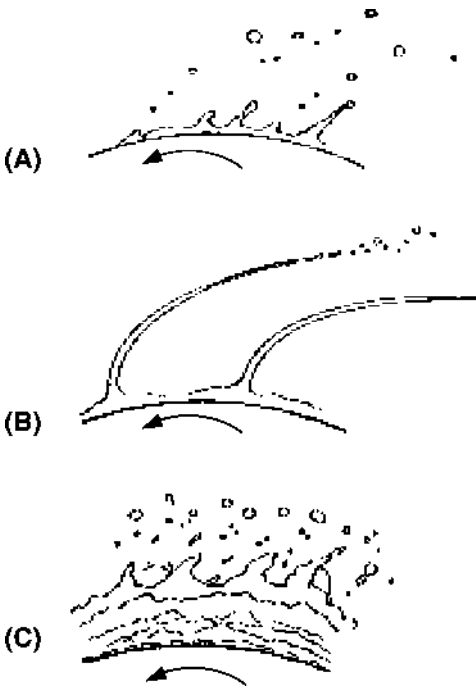
In addition to open-cycle and closed-cycle systems, there are semiclosed-cycle layouts which are not strict in terms of type of drying medium and are operated under slight vacuum conditions.

## 4. THEORY OF SPRAY DRYING FUNDAMENTALS

### 4.1. Droplet Formation

#### 4.1.1. Rotary Atomizer

During rotary atomization, bulk liquid feed is accelerated to a high centrifugal velocity. During this acceleration, the liquid feed forms a thin film over the rotating surface. For smooth disk atomizers, the film or liquid feed disintegrates into droplets at the edge of the wheel by one of the three mechanisms: (a) direct droplet formation, (b) ligament formation, or (c) sheet formation as shown in [Figure 9](#), respectively. The type of droplet formation mechanism that occurs during processing is a function of the surface tension and viscosity of the feed as well as the wheel speed and feed rate (12). Direct droplet formation occurs at low wheel speeds when surface tension and viscosity dominate the atomization mechanism. The other variables that could potentially affect direct droplet formation are inertia and air friction. However, due to liquid slippage on the surface of the wheel, inertia is limited and the low release velocities minimize air friction effects so that the effect of these variables is minimized at low wheel speeds. As wheel speeds and feed rates increase, the amount of feed in each vane increases giving rise to ligaments instead of droplets on the periphery of the wheel. These ligaments disintegrate into droplets with larger droplets forming from feeds with higher viscosity and higher surface tension. While the first two atomization mechanisms are partially controlled by the physical properties of the feed, sheet formation is a result of inertial forces becoming predominant over these properties. At high wheel speeds and feed rates, the ligaments join to form a liquid sheet that extends beyond the edge of the wheel. The liquid sheet



**Figure 9** Smooth disk atomizer droplet formation mechanisms: (A) direct droplet formation, (B) ligament formation, and (C) sheet formation. (From Ref. 12.)

disintegrates into a broad droplet distribution as it extends from this edge. In order to produce a narrow droplet distribution from this mechanism, high wheel speeds are combined with low wheel loading, which is often achieved with a decreased feed rate.

In contrast, a vaned wheel directs the flow of the liquid feed across the surface of an inner liquid distributor in which liquid slippage over the surface of the distributor occurs until there is contact with the vane or channel. The feed then flows outward due to centrifugal force and forms a thin film across the surface of the vane. As the liquid film leaves the edge of the vane, droplet formation occurs as a result of the radial and tangential velocities experienced. Atomizer wheel characteristics that influence droplet size include speed of rotation, wheel diameter, and wheel design, e.g., the number and geometry of the vanes.

#### 4.1.2. Two-Fluid Nozzle

Using the two-fluid nozzle, also referred to as a pneumatic nozzle, atomization is achieved by impacting the liquid feed with high-velocity air, which results in high frictional forces that cause the feed to disintegrate into droplets. In order to achieve optimal frictional conditions, this high relative velocity between liquid and air can be accomplished by either expanding the air to sonic velocities or destabilizing the thin liquid film by rotating it within the nozzle prior to spray-air contact.

There are several two-fluid nozzle designs available to produce the conditions necessary for liquid-air contact. A common design is one in which the liquid and air come into contact outside the nozzle. This nozzle is often referred to as an external mixing nozzle and its main advantage is the greater control available over the

atomization through the independent control of both the liquid and the air streams. Other two-fluid nozzle designs include: (a) an internal mixing design with the air and liquid contacting within the nozzle head, (b) a combined internal–external mixing design created by using two airflows in the nozzle head (also called three-fluid), and (c) a pneumatic cup design with liquid–air contact occurring at the rim of a rotating nozzle head.

In general, two-fluid nozzles are capable of producing small droplet sizes over a wide range of feed rates. These droplets are then carried away from the nozzle by the momentum of the spray and the expanding atomizing air. The most important variable involved in the control of droplet size is the mass ratio of airflow to feed rate, which is also known as the air-to-feed ratio. An increase in this ratio causes a decrease in droplet size. This ratio generally ranges from 0.1 to 10. At ratios approaching 0.1, atomization is difficult even for low-viscosity feeds while a ratio of 10 approaches the limit above which atomization occurs using excess energy without an appreciable decrease in particle size (13).

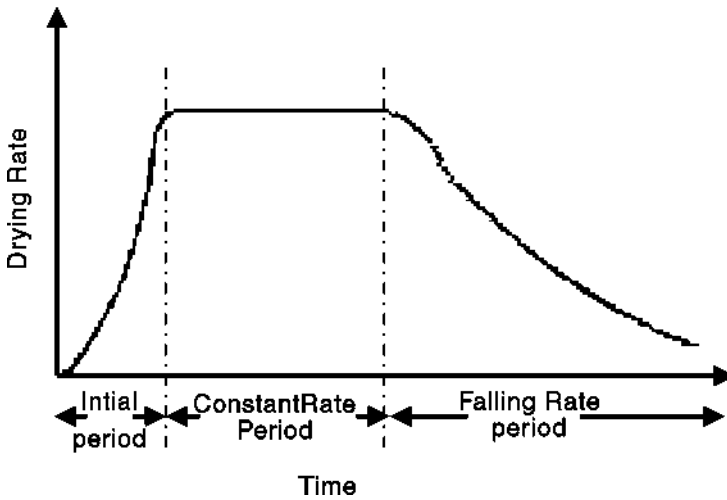
Sprays formed by two-fluid nozzles are symmetrical with respect to the nozzle axis and have a cone-shaped pattern. The angle of this cone is called the spray angle and, for two-fluid nozzles, it is narrow and cannot be varied greatly by adjusting the air-to-feed ratio. The maximum spray angle available is 70–80°, which can be obtained by employing the maximum feed rate and airflow in a high-throughput nozzle. In general, an increase in air pressure will increase the spray angle if the feed rate is maintained at a constant level as long as the maximum angle has not been obtained. Spray angles are maintained if an increase in airflow is accompanied by an increase in feed rate resulting in a similar air-to-feed ratio.

## 4.2. Droplet Drying Mechanisms

Evaporation of water from a spray is often characterized using a curve that describes the change in drying rate as a function of time. This drying rate curve or evaporation history is a function of temperature, humidity, and the transport properties of the droplet formulation as well as the air surrounding the droplet. However, many characteristics of droplet evaporation can be characterized using a general drying rate curve (Fig. 10).

The general drying rate curve has three main phases: an initial drying phase, a phase in which the rate of drying is mainly constant, and a final phase during which the rate of drying decreases (falling rate phase) (15). During the second phase, the removal of moisture from the droplet is at a near-constant rate representing the highest rate achieved during the evaporation history. This constant evaporation rate results in a near-constant droplet surface temperature with the wet bulb temperature representing the droplet temperature. During this phase, the majority of the droplet moisture is removed. The droplet surface is maintained at saturation by moisture migration from within the droplet to the surface. In contrast, during the falling rate phase, the rate of moisture migration is rate limiting to the drying rate causing a decrease in the overall rate of drying. The surface moisture content is no longer maintained and the droplet temperature rises.

This general drying rate curve is directly applicable to the spray-drying process. The initial drying phase begins during the spray–air contact phase immediately upon contact of the droplet with the drying air. During this initial phase, as the drying rate increases toward equilibrium, a slight increase in droplet surface temperature occurs.



**Figure 10** General drying rate curve. (From Ref. 14.)

The drying rate continues to increase until equilibrium across the droplet–air interface is established and the drying rate becomes constant. In the later phase, the solid layer of the spray-dried particle becomes rate limiting to mass transfer and the drying rate decreases. The evaporation rate continues to decrease until the droplet reaches equilibrium moisture content with the surrounding air stream unless the product is removed from the spray dryer before equilibrium moisture content is reached. In addition, all evaporation histories, regardless of material type or spray dryer configuration, have two main points in common: the majority of the evaporation is completed in an extremely short time interval, usually  $<1.5$  sec, and the temperature of the drying air decreases rapidly during evaporation.

While the general evaporation history is representative of the processes occurring during spray drying, the actual rate of moisture migration is affected by several factors including the temperature of the surrounding air. If the inlet temperature is so high that the evaporation rate is higher than the moisture migration rate needed to maintain surface wetness, the constant rate drying phase is very short. This is because a dried layer forms instantaneously at the droplet surface that acts as a barrier to additional moisture transfer and retains moisture within the droplet causing the surface temperature to be much higher. In contrast, lower inlet temperatures actually yield a lower initial drying rate with a surface temperature equal to wet bulb temperature for a longer period of time.

It is important to note that the drying curve is only representative. In reality, there are no defined points during an evaporation history. Some phases may not even occur or will be very short depending on the process conditions. One example of this is a spray-drying process for a heat-sensitive material where the inlet temperature is low. In this case, the initial phase may extend until a critical point where moisture migration becomes rate limiting, effectively eliminating the constant rate drying period. In reality, the actual evaporation rate is dependent on several factors including the droplet shape, composition, physical structure, and solids concentration. The actual drying time is a sum of the constant rate period and the falling rate period until the desired moisture content is achieved.

### 4.3. Effect of Formulation on Droplet-Drying Mechanisms

Droplet composition also plays a significant role in droplet evaporation history. Typically, sprays are differentiated into three main types: pure liquids, feeds containing undissolved solids, and feeds containing dissolved solids (16).

#### 4.3.1. *Pure Liquid Sprays*

For sprays composed of pure liquids, the droplet evaporates away completely. While this type of spray is not useful for pharmaceutical formulations, its behavior is representative of very dilute feed materials. The evaporation of pure liquids is dependent on the dryer configuration. For low-velocity sprays in a low-velocity air stream (countercurrent dryer) or for low-velocity sprays in a high-velocity air stream (cocurrent dryer), the evaporation of the pure liquid spray causes the air temperature and the evaporation rate to decrease. Pure liquid sprays having a wide droplet distribution evaporate more quickly than narrow distributions having the same mean droplet size due to the smaller droplets in the wide distribution. In addition, the size distribution of the droplet changes during evaporation. If the initial spray is a homogenous or very narrow distribution, the mean droplet diameter decreases during evaporation. In contrast, if the initial spray is nonhomogenous or a wide distribution, then the mean droplet diameter initially increases prior to decreasing. In general, a distribution is the best representation of a spray since the mean of this distribution may not adequately describe all characteristics of the distribution. For dryer configurations of high relative velocities such as coarse atomization in cocurrent or fountain-type dryers, the droplets travel farther before a given fraction is evaporated. The relative velocity between droplet and drying air affects evaporation rates more significantly at higher velocities and higher drying temperatures.

#### 4.3.2. *Feeds Containing Insoluble Solids*

For droplets containing insoluble solids, the droplet temperature is equal to the wet bulb temperature of the pure liquid droplet during the constant rate phase since insoluble solids have negligible vapor pressure lowering effects. The total drying is the sum of the two drying periods. The drying time for the first period is short compared to the falling rate period. The falling rate period depends on the nature of the solid phase and can be estimated given the specific gravity of the feed slurry, the density of the dried product, and the thermal conductivity of the gaseous film around the droplet, where gaseous film temperature is the average between the exhaust temperature and droplet surface temperature. The droplet surface temperature is equal to the adiabatic saturation temperature of the suspension spray.

#### 4.3.3. *Feeds Containing Dissolved Solids*

Droplets containing dissolved solids have lower evaporation rates than pure liquid droplets of equal size. The dissolved solids decrease the vapor pressure of the liquid, thus reducing the driving forces for mass transfer. Drying results in the formation of a solid crust at the droplet surface, which does not occur from pure liquid droplets. Vapor pressure lowering causes droplet temperature to increase over wet bulb temperature as in the previous two examples. Formation of dried solid during evaporation has a significant effect on the subsequent evaporation history. During evaporation, spray-air contact and constant rate period occur but may be shorter. The main effect of dissolved solids is seen when the first period of drying ends and droplet moisture

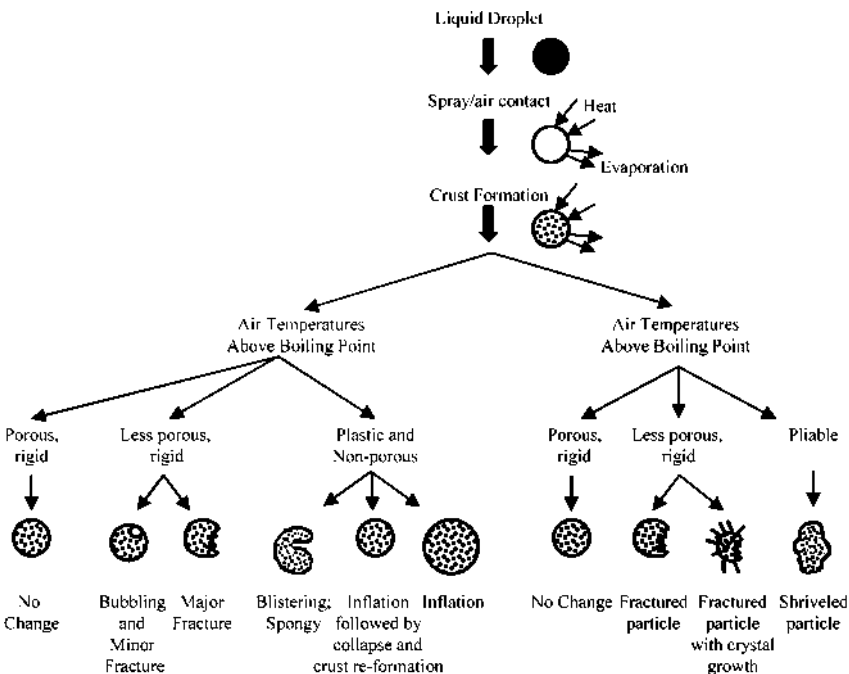
content falls to critical value representing the formation of the solid phase at the surface. During the falling rate period, the migration of moisture decreases due to resistance to mass transfer caused by solid phase increasing. Last, the heat transfer is greater than the mass transfer and the droplet temperature increases. Vaporization of the moisture within the droplet during this phase may occur if the transfer is sufficiently high.

The relationship between mass transfer and heat transfer for droplets containing dissolved solids can lead to the formation of many different particle morphologies depending on process conditions and material characteristics. Charlesworth and Marshall have defined these morphologies as falling into two groups dependent on the temperature of the drying air relative to the boiling point of the droplet solution during the major part of the evaporation period (Fig. 11) (17).

If the air temperature exceeds the boiling point of the droplet solution, then a vapor will be formed. As the solid crust forms around each droplet, vapor pressure within the droplet is formed and the resultant effect of this pressure is dependent on the nature of the crust. A porous crust will release the vapor, but a nonporous crust may rupture resulting in fractured particles or fines from disintegrated particles.

Alternately, the droplet temperature may not reach boiling point levels due to cocurrent airflow or because the residence time of droplets in the hottest regions of the dryer is often very short. In this case, moisture migration occurs through diffusion and capillary mechanisms.

In both cases, the porosity of the solid crust is often evident in the characteristics of the falling rate period of the drying curve. If the film is highly nonporous, the rate will fall sharply and the evaporation time will be prolonged. However, if a highly



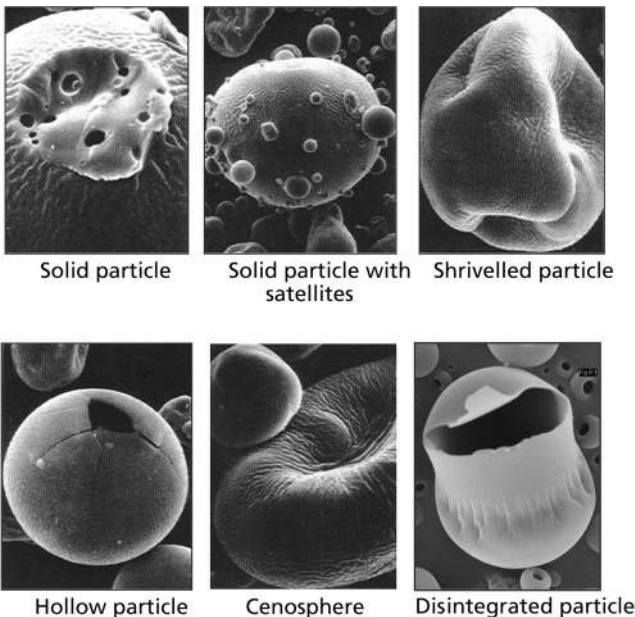
**Figure 11** Potential spray-dried particle morphologies in relation to process conditions and material characteristics. (From Ref. 17.)

porous film exists, then vapor is easily removed from the droplet–air interface and the drying rate is similar to that found during the first period of drying.

These drying mechanisms result in a range of particle shapes including solid, hollow, shriveled, and disintegrated, examples of which are shown in Figure 12. However, it is important to note that particle morphology is also dependent on several material characteristics including solubility, temperature of crystallization, melting point, and thermal conductivity since they will also impact the rate of crust formation, the porosity of the crust, and the subsequent drying rate.

It is also possible to influence particle density and size distribution through the modification of process parameter settings such as atomizer settings, temperature levels, and feed rates (18). For example, an increased feed rate while maintaining a constant inlet temperature results in particles that have higher moisture content and a resultant increased bulk density. By increasing the temperature of the feedstock, the ability of the feed to be atomized is often improved due to the reduction in ligament formation causing an increase in the bulk density of the dried particles. Also, an increase in the concentration of the feed solids often increases the bulk density of the dried particle, as does the use of a rotary atomizer, since many wheel designs reduce air entrapment. Alternatively, bulk density may be decreased through feed aeration or an increase in inlet temperature. Also, cocurrent spray-air contact is often effective for reduction in bulk density because the wettest droplets encounter the hottest air facilitating rapid evaporation and air entrapment. It is important to note that the outlined process modifications are generally applicable, but that exceptions to each can be found based on material characteristics.

In a similar manner, it is often possible to influence spray-dried particle size distribution by changing process parameter settings. As mentioned earlier, the size of the droplets formed during atomization is affected by process parameters such as atomization type, atomizer settings, feed solids concentration, feed physical



**Figure 12** Various particle forms of skim milk powder. (Courtesy of Niro Pharma Systems.)



properties, and drying temperatures. The size of the resultant particles following evaporation is a function of the initial droplet size as well as the material characteristics such as solid state and film formation mechanisms.

## 5. SPRAY DRYING APPLICATIONS

### 5.1. Feasibility Assessments

Before any spray-drying application work begins, it may be advantageous to conduct the following simple, qualitative tests at the laboratory bench using very little material to determine the feasibility of the application (19). A rheological profile of the solution or suspension should be evaluated or, alternatively, a small sample can be tested to see if droplets from a stirring rod can be readily formed. In the latter test, if the liquid strings from the surface or forms peaks, then high viscosity is indicated and the product may not be a candidate for spray drying without formulation changes. The behavior of non-Newtonian fluids (pseudoplastic, thixotropic, dilatant, etc.) has been found to influence atomization and the resultant droplet size (20). However, while it is expected that Newtonian and non-Newtonian fluids atomize differently, this difference was not found to be as important as the more significant effect of the wheel speed on droplet size. It is also important to note that highly viscous materials cannot be atomized by pressure nozzles.

Once the effect of viscosity has been evaluated, it may be advisable to dry a few drops of product on a glass slide using a heated air gun. During this bench drying test, the air temperature is recorded and the material is observed for the presence of stickiness, color changes, or other physical changes. If the dried powder is found to be suitable at the air temperature applied, it can be placed on a variable temperature hot bench to determine the temperature at which the powder becomes tacky. For spray drying to be successful, this temperature must be higher than the outlet temperature of the dryer.

If the initial feasibility evaluation is successful, it is reasonable to commit additional materials for a spray-drying trial. A laboratory dryer at least 500 mm in diameter is recommended for such tests. Bench-scale spray dryers are available but are limited in their ability to provide adequate atomization or sufficient process air flow for the successful production of dried particles. The laboratory unit, however, combined with very fine atomization (two-fluid or rotary) will often produce acceptable product for further testing. A series of tests can be performed at different inlet–outlet temperature combinations using small quantities of material and these samples can be tested for chemical stability to evaluate thermal effects from process air contact. The relationship between outlet temperature and final product moisture can also be established for this scale. While samples produced in a laboratory dryer are suitable for evaluating the effect of spray drying on the product, they are not suitable for use in downstream processing because the fine particle distribution produced as a result of the small drying chamber dimensions may not be representative of the final spray-dried product.

Production of coarser particles requires a larger, pilot-scale dryer, which in turn requires larger feed volumes. This pilot-scale work is often conducted at a spray-drying development center since many companies have laboratory dryers but few have the sizes and variety of process types needed to fully develop a spray-dried product from pilot scale through 1/10th of the commercial scale and into final production. These facilities are usually found at spray-drying manufacturers or custom

processing companies. In addition to having the equipment, manufacturers and custom processors often have the expertise to more quickly optimize product characteristics.

## 5.2. Spray Drying to Produce a Specific Type of Particle

Because of its inherent costs, spray drying is not always considered as a processing option for many conventional formulations. However, when a specialized particle type is required by the active ingredient or dosage form, spray drying can become a feasible alternative to more conventional manufacturing processes. Such particle types include microcapsules, controlled release particles, nanoparticles, and liposomes. The application of spray drying to pharmaceuticals has been extensively discussed in review articles (21,22).

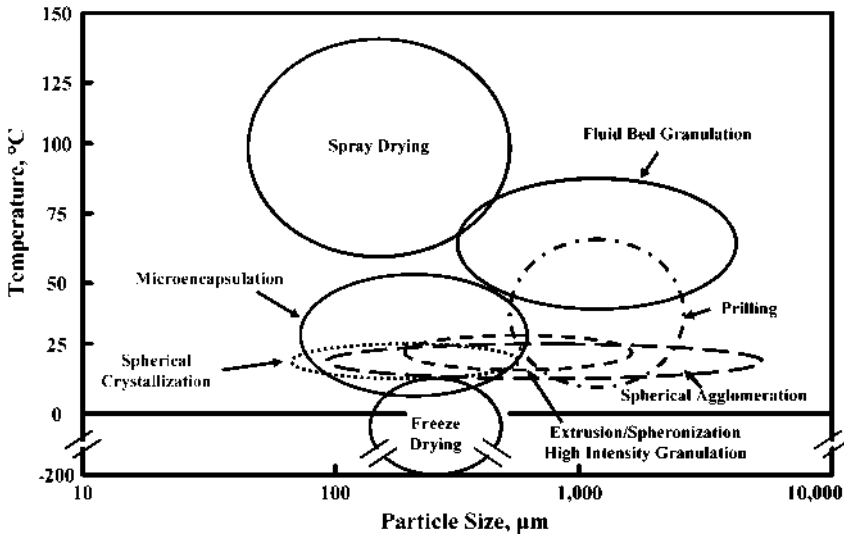
### 5.2.1. Granulation

Spray drying is a unique process in several ways as compared to other granulation methods. The feedstock is a homogenous liquid, which results in the uniform distribution of all components of the spray-dried product in the same ratio in each individual particle and eliminates the concerns of uniformly granulating dry components with a liquid. While granule characteristics may exhibit batch-to-batch variation, which in turn may influence the compaction behavior of the formulation or the postcompaction properties of the tablet, granules produced using spray drying are extremely consistent in terms of particle size, bulk density, and compaction behavior. These features make spray drying a suitable process for the production of directly compressible excipients such as lactose, microcrystalline cellulose, and mannitol. Spray-dried lactose is by far the most commonly encountered spray-dried excipient (21).

Many granulation methods utilize mechanical energy to transform very fine particles into granules. Although shear forces are employed in nozzle and centrifugal atomizers to create sprays, this form of energy will not destroy microencapsulated material as can happen in high-shear granulation. In spray drying, some trial and error is encountered in establishing the nozzle combinations and liquid pressures to obtain equivalent particle size distribution during scale-up; however, the resultant powder will have similar physical properties such as bulk density and compaction. Also, it is important to note that, within the spray dryer, the product is never in contact with moving parts, which facilitates the proper cleaning process greatly.

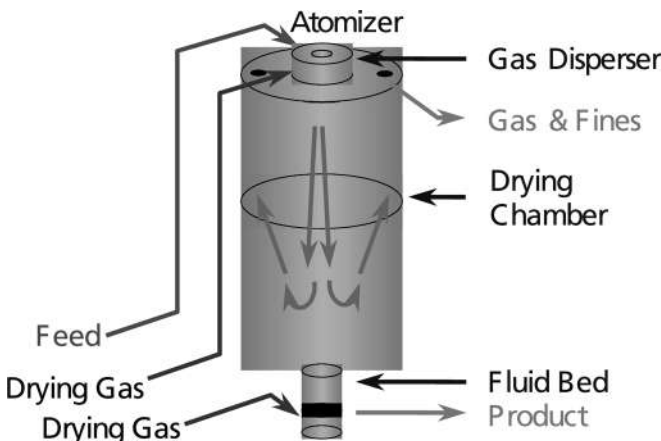
If the granulation size is a critical criterion for a given formulation, then the selection of the granulation process may be determined based on the desired particle size and feasible operating temperatures. [Figure 13](#) compares the general particle size limitations of numerous granulation techniques.

As seen in this figure, the spray-drying process results in smaller-size particles as compared to some other granulation methods such as fluid-bed granulation or high-shear (high-intensity) granulation. One option for producing larger agglomerates using spray-drying technology is to employ fluidized spray drying, which combines the features of the spray-drying process with fluid-bed granulation. The result of this process is particles similar to those obtained from a fluid-bed granulation operation, and yet the process is a continuous type in contrast to the batch operation of a fluid-bed granulator. In a fluidized spray-drying system, the bottom cone of a conventional spray dryer has been modified to include an integral fluid bed

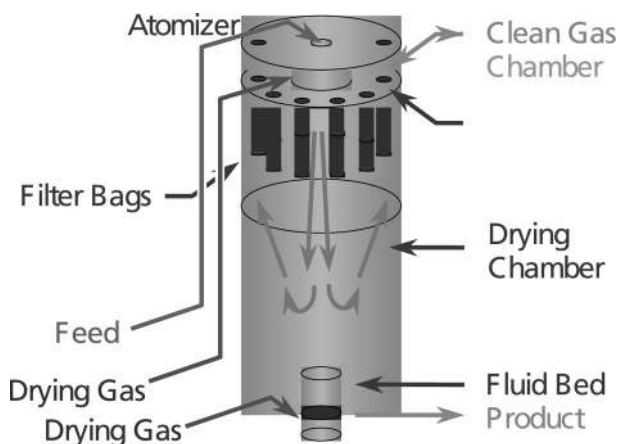


**Figure 13** Particle size range of the methods utilized in particle growth. (From Ref. 21.)

(Fig. 14). When this process is implemented, atomization and spray–air contact occur as they do in a conventional spray dryer. However, when the partially dried particles reach the lower portion of the dryer, instead of undergoing product separation, the particles are fluidized by the second stream of drying gas. Controlled temperature and humidity of this fluid bed gas stream ensure that the particles retain enough moisture to be suitable for agglomeration. At the end of the process, each granule is an agglomerate of spray-dried droplets. Droplets that dry completely before agglomerating and granules that experience attrition during fluid-bed drying create fines, which are entrained in the gas stream and carried upward to the drying gas exhaust. As a result, these fines pass through the atomized spray, providing an additional opportunity for agglomeration. Fines that are carried through the exhaust



**Figure 14** Schematic of fluidized spray drying system (FSD™). (Courtesy of Niro Pharma Systems.)



**Figure 15** Schematic of an integrated fluid-bed dryer (IFD™). (Courtesy of Niro Pharma Systems.)

are collected in cyclones or a bag collector and can be pneumatically recycled into the dryer.

A variation of this system is the integrated fluid-bed dryer (Fig. 15). This system includes integrated filter bags, which are suspended from the chamber roof. This roof is perforated and serves a dual purpose as a gas disperser. The chamber above the roof contains clean gas that supplies the inlet process drying air and also has an exhaust point for clean gas, since any remaining fines are entrapped in the filters.

Products produced using fluidized spray drying have a broader particle size distribution and lower bulk density than the particles produced by conventional spray dryers with a typical mean size particle size range of 150–400  $\mu\text{m}$ . This process is not meant to replace conventional spray drying processes but instead is a feasible alternative for spray drying applications that require larger mean particle sizes.

### 5.2.2. Modification of Solid-State Properties

Characterization and modification of solid-state properties of drug substances are profoundly important in developing pharmaceutical products with the desired drug release properties. The importance of the process understanding and improvement of the dissolution rate for poorly water-soluble drugs has been known for decades (24). Particle size reduction methods (such as grinding, micronization, and ball milling), precipitation, melt quenching, freeze drying, and spray drying have been used extensively for improving the solubility and dissolution rate of poorly water-soluble materials (25–30). These processes generally impart a polymorphic change in the drug substance by transforming a low-energy crystalline form to a higher-energy crystalline form or amorphous form.

Spray drying has many advantages over the other methods in achieving such improvements. First, the spray-dried particles are generally free-flowing and spherical; thus, no additional processing (such as dry granulation) is needed before compaction of these particles. The hollow structure of the spray-dried particles increases the solubility and subsequent dissolution rate of the drugs by several folds. For example, the dissolution rate of poorly water-soluble salicylic acid was found to be almost instantaneous and 60 times faster when spray dried as compared to that of the original powder (25).

In addition, the energy of the amorphous state depends, to some extent, on the method of preparation (26). The rapid nature of the spray-drying process (i.e., the short residence time of the droplets during drying) improves the stability of otherwise unstable amorphous forms.

Last, the spray-drying process is suitable for integration of stability agents (such as PVP and PEG) into spray-dried particles. Spray drying of the poorly soluble drug with 50% PVP resulted in enhanced dissolution when compared to a physical mixture of micronized drug with PVP (27). A physically stable amorphous form of ibuprofen, which has a low melting point, was obtained when spray dried in the presence of 50–75% PVP (28). Recently, in a study on the effect of spray drying varying lactose/PEG compositions, it was found that the most amorphous particles were obtained when PEG was present at 10% (w/w) concentration. Conversion to more crystalline materials occurred over time and the crystallization of lactose appeared to be retarded at low PEG concentrations (29). In other work, the increased amount and molecular weight of PVP was found to have the potential to increase the physical stability of amorphous lactose (30).

### 5.2.3. *Microencapsulation*

The preparation of microcapsules involves the coating of particles or liquid droplets with a biodegradable polymer. Applications for microspheres in the pharmaceutical industry include controlled release, particle coating, flavor stabilization, taste masking, and physical or chemical stabilization. Microencapsulation can be achieved through a number of processes, but, in general, an active pharmaceutical ingredient (API) is trapped within a reservoir or matrix. This process often begins with the preparation of a three-phase, immiscible system containing a liquid vehicle, a core particle, and a coating material or polymer. Several manufacturing techniques can be employed to deposit the polymer around the particle and cause this coating to become rigid. These methods include spray drying, Wurster fluid-bed coating, pan coating, coacervation, and emulsion evaporation. In the spray-drying process, the encapsulation process is achieved in one step in which desolvation and thermal cross-linking occur concurrently and the particle is coated. A review of the main factors involved in the application of spray drying for achieving microencapsulation references many works which detail pharmaceutical applications, especially drug delivery systems (31).

Microencapsulation is a process that is often used for the purpose of providing controlled release of a protein or drug. Several authors have studied microencapsulation formulations manufactured from a spray-drying process as a means to achieve controlled release. In one case, the effect of polymer hydrophilicity on API release was evaluated and the most hydrophilic polymer was found to gel faster and retard drug release the most (32). The size and cohesiveness of the resultant spray-dried particles were found to be a function of the polymer and also affected drug release with the smaller, more cohesive particles tending to agglomerate and delay drug release. In another case, release of a model drug was controlled using a spray-dried, water-activated, pH-controlled microsphere (33). Water influx into the microcapsule caused buffer to dissolve and adjusted the inner pH causing the fraction of unionized drug to increase resulting in the increased release of the drug.

One specific polymer type that has been employed in the spray drying of microspheres to modify release is acrylic resin. A commercial blend of neutral methacrylic acid esters was used for the preparation of spray-dried controlled release microcapsules containing model drugs (34). Dissolution results of tablets compressed from the

microspheres showed successful controlled release with advantages over a matrix system. In a similar study, sustained release and enteric tablets were prepared by directly compressing spray-dried microspheres produced using different types of acrylic resins (35). Complete enteric properties were observed for tablets made from pH-dependent, anionic acrylic polymers, while a sustained release profile was observed for tablets made from microspheres containing pH-dependent, cationic acrylic polymers.

Two common biodegradable polymers used in microencapsulation are polylactide (PLA) and polylactide-*co*-glycolide (PLGA). The efficacy of spray drying as a method for PLA and PLGA microsphere preparation was investigated using a model lipophilic drug (36). The spray-drying process was tailored to each polymer and the microspheres obtained were evaluated for shape, size, drug content, and polymer influence on these characteristics. Polymer type, polymer molecular weight, and polymer concentration were shown to be the greatest contributing factors to these characteristics. In-vitro dissolution testing revealed different release profiles depending on polymer type and microsphere morphology.

#### 5.2.4. Inhalation Dosage Forms

In order for inhalation dosage forms to be clinically effective, the drug should deposit in the lower airways. In general, the site of drug deposition in the lungs depends on the particle size and size distribution of the drug particles or droplets, the inhaler device and formulation, the patient's breathing patterns, and airway geometry (37). Generally, the aerosol particles or droplets must be  $<5\ \mu\text{m}$  aerodynamic diameter to be deposited into the lower respiratory tract.

A formulation of mucoadhesive microspheres for nasal administration was examined through the preparation of microspheres containing active and one of two polymer types using a spray-drying procedure (38). The mean diameter of the spray-dried particles was 3–5  $\mu\text{m}$  and surface morphology was dependent on polymer type. Microspheres containing active and either polymer were more mucoadhesive than any of the starting materials alone and the dissolution rate decreased with increasing polymer content.

The ability to control the particle size and density of particles for inhalation was investigated using lactose solutions atomized with a two-fluid nozzle and dried in a laboratory scale dryer. It was found that droplet size during atomization was affected by nozzle orifice diameter and atomization airflow but not by feed concentration. However, dried particle size was influenced by feed concentration and it was suggested that the shell thickness of the hollow particles increased with increasing feed concentration (39).

An alternative method of atomization for the formation of respirable particles is the airblast atomizer. This type of two-fluid nozzle introduces a liquid feed pumped at a slow rate into a high-velocity gas stream via single or multiple jets. This atomizer type was utilized at laboratory scale to evaluate the effect of grounded vs. electrostatically charged tower configurations on the median particle size of the spray-dried product (40). This study found significant differences between the two configurations with the latter producing small particles but compromising collection efficiency.

### 5.2.5. *Nanoparticles*

Attempts have been made to manufacture particles on the nanometer scale for applications such as controlled release and intravenous delivery systems. A comparison evaluating the processability and solid dosage performance of spray-dried nanoparticles and microparticles was conducted (41). In this study, nanoparticle suspensions were prepared by wet comminution in the presence of stabilizers, converted into dried particles using a spray-drying process and subsequently compressed. Compacts prepared from microparticles and nanoparticles were found to differ in their internal structure and micromechanical deformations.

In another study, solid, lipid nanoparticles were produced using high-pressure homogenization and loaded with drug using hot or cold methods for lipophilic or hydrophilic drugs, respectively (42). Surfactant addition was investigated and stability and entrapment efficiency were evaluated. Long-term sterile storage of these dispersions was difficult and spray drying was investigated as a potential, feasible technique.

The feasibility of developing nanoparticles for aerosol delivery has also been investigated (43). The spray-dried nanoparticles produced using one carrier type were found to be hollow while others had a continuous matrix. Particle size was measured before spray drying and after the spray-dried powder was re-dissolved. Both carrier types resulted in an increase in particle size after spray drying, although both were found to remain in the nanometer range after drying and were suitable for efficient lung delivery.

### 5.2.6. *Liposomes*

Another particle type capable of being produced by spray drying is liposomes. Traditional preparation of liposomes begins with the preparation of a solution containing the lipids to be used in a volatile organic solvent mixture. Following filtration of the solution, the solvent mixture is removed under conditions which ensure that phase separation does not occur. The dry lipid mixture is then hydrated by an aqueous mixture containing the drug to be entrapped. Last, this mixture is dried. Spray drying is one method available for accomplishing one or both of these drying steps. For example, lipid vesicles were produced using a spray-drying process instead of the first step of the traditional process (44). Vesicles containing phosphatidyl choline (soybean lecithin) were produced by extruding the phospholipid through a 0.2  $\mu\text{m}$  polycarbonate membrane followed by spray drying with 10% lactose. The particle size, vesicle size distribution, and stability of the multilamellar vesicles were measured. The mean particle diameter after spray drying with a rotary atomizer was 7  $\mu\text{m}$  and the dry particles could be reconstituted in water to liposomes without any major change to the vesicle size distribution. In addition, the chemical stability of the liposomes was not significantly affected by the spray-drying process. In subsequent work, the same authors utilized spray drying for the hydration step of the traditional process (45).

### 5.2.7. *Peptides and Proteins*

Recent advances in biotechnology have made it possible to use macromolecules such as peptides and proteins as therapeutic agents. Spray drying has been used for decades for processing antibiotics, vaccines, and, for the last few decades, macromolecular drugs.

The effect of spray drying process parameter settings on the activity of peptides and proteins is often difficult to study. Consequently, enzymes are frequently used as model protein drugs due to the ease with which their activity can be determined. Investigations of the application of spray drying for the production of some enzymes and proteins and the effects that processing parameters have on enzyme activity have been discussed in a review article (21).

Many proteins and peptides are susceptible to degradation upon spray drying due to relatively high temperatures. In a recent study, the effects of inlet and outlet temperatures on some spray-dried peptides and proteins were reported (46). In another study, enzyme activity was found to be susceptible to spray-drying temperature and only half of its activity remained after spray drying without additives at outlet temperatures  $<50^{\circ}\text{C}$  (47). In this study, it was found that the activity of a formulation consisting of enzyme and mannitol was maintained at outlet temperatures  $<50^{\circ}\text{C}$  and compromised at temperatures  $>50^{\circ}\text{C}$ . Replacing mannitol with trehalose stabilized the spray-dried enzyme and its activity was maintained at 100% at an outlet temperature of  $100^{\circ}\text{C}$ .

#### 5.2.8. *Dry Elixirs and Emulsions*

A dry elixir is a novel dosage form developed by spray-drying actives and excipients dissolved or suspended in ethanol/water mixtures. One example is a dry elixir in which the feed solution contained actives, dextrin, and sodium lauryl sulfate in a mixture of ethanol/water (48). The spray-dried product was spherical in shape with a smooth surface and a mean diameter of  $13\ \mu\text{m}$ . A comparison with the active in powder form revealed a major decrease in dissolution time from  $>60$  to 2 min.

A similar dosage form to the dry elixir is the dry emulsion. In this case, the emulsified drug or oily drug solution with additives is spray dried to produce dry emulsion particles. A dry emulsion of a water-insoluble nutrient was studied and release from the spray-dried particle was found to be dependent on the type and amount of oily carrier and surfactant used (49). Differences in release among the different formulations were attributed to the differences in the physical state of the drug and surfactant in the dried particle.

#### 5.2.9. *Effervescent Products*

Spray-dried particles have also been incorporated into effervescent products. In one study, spray drying was used to protect a degradation-sensitive active by coating fine particles of the drug with a sugar alcohol solution (50). In vivo results of tablets made using the spray-dried particles combined with coated citric acid and sodium bicarbonate revealed that the active was rapidly absorbed from the tablet.

#### 5.2.10. *Other Process Variations*

Two variations of the spray-drying process have been developed in response to product requirements. The first variation is spray congealing. In this process, solids such as wax or monoglycerides are melted. Other ingredients such as drugs, flavors, or fragrances are dissolved or suspended in the molten material. This molten feed is sprayed using the same basic spray-drying equipment except that no heat source is required. Depending on the freezing point of the feed, ambient or chilled air may be used during the drying process. This process has been described in more detail and a comparison between particles produced by both the spray drying and the



spray congealing techniques has also been drawn (51). One study compared microcapsules produced using both methods and found that the solvent used, the lipid type, and the chain length were variables that influenced the surface properties of both particle types (52,53).

A second variation of the spray drying process is spray freeze drying. In this process, the feed is sprayed into freezing air causing the droplets to freeze. The frozen droplets are subsequently sublimed under vacuum conditions producing a dry product. One study investigated this method further by eliminating the use of vacuum conditions for sublimation (54). In this study, the feasibility of spraying pharmaceutical solutions at atmospheric pressure was investigated using very low air temperatures and desiccated air for the removal of the water from the frozen particles. The process resulted in fine, free-flowing powder with a high surface area, good wetting, and good solubility characteristics.

Another type of atomization employed for pharmaceuticals is supercritical fluid nebulization. The process uses carbon dioxide as an aerosolization aid, which permits drying at lower temperatures than is usually needed in conventional spray drying (55). Within the atomization system, supercritical carbon dioxide is intimately mixed with aqueous solutions containing API, often proteins or peptides. The outcome is the formation of microbubbles, which are rapidly dried in <5 sec, resulting in dried particles predominately <3  $\mu\text{m}$  in diameter (56,57). This method is generally applied for the production of materials for pulmonary use or to achieve increased bioavailability (58).

## 6. CONCLUSION

Spray drying has found many applications in numerous industries. The scale-up of the spray drying process is less troublesome as the operation requirements of small and large dryers are the same when compared to other conventional granulation processes such as high-shear granulation method.

Spray drying, being a continuous process, is well suited for the production of bulk drug substances and excipients. Using this process, the physical properties of the resulting product (such as particle size and shape, moisture content, and flow properties) can be controlled through the selection of equipment choices and manipulation of process variables; thus, the final spray-dried particulate matter may not need further processing (wet or dry granulation) before compaction. In addition, the spray-drying process matches the directives outlined in the Process Analytical Technology Initiative which is currently being guided and championed by the FDA (59).

Spray-drying processes offer several advantages when solid-state properties of drug substances need to be modified. Using this process, solubility and dissolution rates of properties of poorly soluble materials can be increased several fold and the stability of the amorphous form of the materials can be improved significantly.

Because of its initial inherent costs, spray drying is not always considered as a processing option for many conventional formulations, especially for small batch size operations. However, when a specialized particle type is required by the active ingredient or dosage form, spray drying can become a feasible alternative to more conventional manufacturing processes. Such particle types include microcapsules, controlled release particles, nanoparticles, and liposomes.

## ACKNOWLEDGMENTS

We gratefully acknowledge the contributions of Niro Pharma Systems, specifically Bob Turock and Jim Schell, for providing the content for several of the figures and Fred Shaw, whose chapter on spray drying in the first edition of this book provided guidance and content. We also acknowledge the significant contribution of Keith Masters whose handbook was referenced extensively as a leading text in the field.

## REFERENCES

1. Traub DA. Spray Dryers, Part 1, Process Heating, August 2001. ([http://www.process-heating.com/CDA/ArticleInformation/Drying\\_Files\\_Item/0,3274,61137,00.html](http://www.process-heating.com/CDA/ArticleInformation/Drying_Files_Item/0,3274,61137,00.html)).
2. Percy SR. Improvement in drying and concentrating of liquid substances by atomizing. US Patent 125,406, April 9, 1872.
3. Masters K. Introduction. Spray Drying Handbook. 5th ed. Essex, U.K: Longman Scientific Technical, 1991:1–20.
4. Traub DA. Spray Dryers, Part 2, Process Heating, September 2001. ([http://www.process-heating.com/CDA/ArticleInformation/Drying\\_Files\\_Item/0,3274,63175,00.html](http://www.process-heating.com/CDA/ArticleInformation/Drying_Files_Item/0,3274,63175,00.html)).
5. Masters K. Spray drying fundamentals: process stages and layouts. Spray Drying Handbook. 5th ed.. Essex, U.K: Longman Scientific Technical, 1991:24.
6. Masters K. Spray drying fundamentals: process stages and layouts. Spray Drying Handbook. 5th ed. Essex, U.K: Longman Scientific Technical, 1991:26.
7. Masters K. The process stages of spray drying. Spray Drying Handbook. 5th ed. Essex, U.K: Longman Scientific Technical, 1991:268.
8. Masters K. Spray drying fundamentals: process stages and layouts. Spray Drying Handbook. 5th ed.. Essex, U.K: Longman Scientific Technical, 1991:31.
9. Masters K. The process stages of spray drying. Spray Drying Handbook. 5th ed. Essex, U.K: Longman Scientific Technical, 1991:271.
10. Masters K. Spray drying fundamentals: process stages and layouts. Spray Drying Handbook. 5th ed. Essex, U.K: Longman Scientific Technical, 1991:43.
11. Masters K. Spray drying fundamentals: process stages and layouts. Spray Drying Handbook. 5th ed. Essex, U.K: Longman Scientific Technical, 1991:47.
12. Masters K. The process stages of spray drying. Spray Drying Handbook. 5th ed. Essex, U.K: Longman Scientific Technical, 1991:199.
13. Masters K. The process stages of spray drying. Spray Drying Handbook. 5th ed. Essex, U.K: Longman Scientific Technical, 1991:255.
14. Traub DA. The Drying Curve, Part 2, Process Heating, October 2002. ([http://www.process-heating.com/CDA/ArticleInformation/Drying\\_Files\\_Item/0,3274,84744,00.html](http://www.process-heating.com/CDA/ArticleInformation/Drying_Files_Item/0,3274,84744,00.html)).
15. Masters K. Drying of droplets/sprays. Spray Drying Handbook. 5th ed. Essex, U.K: Longman Scientific Technical, 1991:309.
16. Masters K. Drying of droplets/sprays. Spray Drying Handbook. 5th ed. Essex, U.K: Longman Scientific Technical, 1991:326.
17. Charlesworth DH, Marshall WR. Evaporation for drops containing dissolved solids. *AIChE J* 1960; 6(1):9–23.
18. Masters K. Drying of droplets/sprays. Spray Drying Handbook. 5th ed. Essex, U.K: Longman Scientific Technical, 1991:345.
19. Shaw F. Spray drying as a granulation technique. Parikh DM, ed. *Handbook of Pharmaceutical Granulation Technology*. New York: Marcel Dekker, 1997:93–96.
20. Filkova I, Weberschinke J. Apparent viscosity of non-Newtonian droplet on the outlet of wheel atomizers. Mujumdar AS, ed. *Drying '82*. New York: McGraw Hill, 1982: 165–170.

21. Broadhead SK, Rouan E, Rhoads CT. The spray drying of pharmaceuticals. *Drug Dev Ind Pharm* 1992; 18(11,12):1169–1206.
22. Wendel SC, Çelik M. An overview of spray-drying applications. *Pharm Technol* 1997; 21(10):124–156.
23. Kadam KL. *Granulation Technology for Bioproducts*. Boca Raton, FL: CRC Press, 1990.
24. Fincher JH. Particle size of drugs and its relationship to absorption and activity. *J Pharm Sci* 1968; 57(11):1825–1835.
25. Kawashima Y, Satio M, Takenaka H. Improvement of solubility and dissolution rate of poorly water-soluble salicylic acid by a spray-drying technique. *J Pharm Pharmacol* 1975; 27:1–5.
26. Pikal MJ, Lukes AL, Land JE, Gaines K. Quantitative crystallinity determination for beta-lactam antibiotics by solution calorimetry: correlations with stability. *J Pharm Sci* 1978; 67:767–773.
27. Junginger K, Wedler M. *Acta Pharm Technol* 1984; 30(1):68.
28. Corrigan OI, Holohan EM, Reilly MR. Physicochemical properties of indomethacin and related compounds co-spray dried with polyvinyl-pyrrolidone. *Drug Dev Ind Pharm* 1985; 11(2,3):677–695.
29. Corrigan DO, Healy AM, Corrigan OI. The effect of spray drying solutions of polyethylene glycol (PEG) and lactose/PEG on their physicochemical properties. *Int J Pharm* 2002; 235(1,2):193–205.
30. Berggren J, Alderborn G. Effect of polymer content and molecular weight on the morphology and heat- and moisture-induced transformations of spray-dried composite particles of amorphous lactose and poly(vinylpyrrolidone). *Pharm Res* 2003; 20:1039–1046.
31. Re MI. Microencapsulation by spray drying. *Drying Technol* 1998; 16(6):1195–1236.
32. Wan LS, Heng PW, Chia CG. Spray drying as a process for microencapsulation and the effect of different coating polymers. *Drug Dev Ind Pharm* 1992; 18(9):997–1011.
33. Sutinen R, Laasanen V, Paronen P, Urtti A. pH-controlled silicone microspheres for controlled drug delivery. *J Controlled Release* 1995; 33:163–171.
34. Palmieri GF, Wehrle P, Stamm A. Evaluation of spray-drying as a method to prepare microparticles for controlled drug release. *Drug Dev Ind Pharm* 1994; 20(18):2859–2879.
35. Takeuchi H, Handa T, Kawashima Y. Controlled release theophylline with acrylic polymers prepared by spray drying technique. *Drug Dev Ind Pharm* 1989; 15(12):1999–2016.
36. Pavanetto F, Genta I, Giunchedi P, Conti B. Evaluation of spray drying as a method for polylactide and polylactide-co-glycolide microsphere preparation. *J Microencap* 1993; 10(4):487–497.
37. Gonda I. Targeting by deposition. Hickey AJ, ed. *Pharmaceutical Inhalation Aerosol Technology*. New York: Marcel Dekker, Inc., 1992:61–82.
38. Vidgren P, Vidgren M, Aronen P, Vainio P, Nuutinen J. Nasal distribution of radioactive drug administered using two dosage forms. *Eur J Drug Metab Pharmacokin* 1991; 3:426–432.
39. Elversson J, Millqvist-Fureby A, Alderborn G, Elofsson U. Droplet and particle size relationship and shell thickness of inhalable lactose particles during spray drying. *J Pharm Sci* 2003; 92:900–910.
40. Dunbar CA, Concessio NM, Hickey AJ. Evaluation of atomizer performance in production of respirable spray-dried particles. *Pharm Dev Technol* 1998; 3(4):433–441.
41. Lee J. Drug nano- and microparticles processed into solid dosage forms: physical properties. *J Pharm Sci* 2003; 92(10):2057–2068.
42. Muller-Mehnert RH, Lucks JS, Schwarz C, Ruhl D, et al. Solid lipid nanoparticles (sln)-alternative colloidal carrier system for controlled drug delivery. *Eur J Pharm Biopharm* 1995; 41(1):62–69.
43. Sham JO, Zhang Y, Finlay WH, Roa WH, Libenberg R. Formulation and characterization of spray-dried powders containing nanoparticles for aerosol delivery to the lung. *Int J Pharm* 2004; 269:457–467.

44. Goldbach P, Brochart H, Stamm A. Spray-drying of liposomes for a pulmonary administration. Part 1. Chemical stability of phospholipids. *Drug Dev Ind Pharm* 1993; 19(19):2611–2622.
45. Goldbach P, Brochart H, Stamm A. Spray-drying of liposomes for a pulmonary administration. Part 2. Retention of encapsulated materials. *Drug Dev Ind Pharm* 1993; 19(19):2623–2636.
46. Costantino HR, Andya JD, Nguyen PA, Dasovich N, Sweeney TD, Shire SJ, Hsu CC, Maa YF. Effect of mannitol crystallization on the stability and aerosol performance of a spray-dried pharmaceutical protein, recombinant humanized anti-ige monoclonal antibody. *J Pharm Sci* 1998; 87:1406–1411.
47. Broadhead J, Ruan SK, Rhodes CT. The effect of process and formulation properties on the properties of spray dried  $\beta$ -galactosidase. *J Pharm Pharmacol* 1994; 46:458–467.
48. Kim CK, Soon YS. Development of digoxin dry elixir as a novel dosage form using a spray-drying technique. *J Microencap* 1995; 12(5):547–566.
49. Takeuchi H, Sasaki H, Niwa T, Hino T, Ozawa H, et al. Design of redispersible dry emulsion as an advanced dosage form of oily drug (vitamin E nicotinate) by spray-drying technique. *Drug Dev Ind Pharm* 1992; 18(9):919–937.
50. Timmington H. Improved aspirin. *Chemist Druggist* 1973; 199:482–483.
51. Killen MJ. Process of spray drying and spray congealing. *Pharm Eng* 1993; 13(Jul–Aug), 56:58–62.
52. Eldem T, Speiser P, Altorfer H. Polymorphic behavior of sprayed lipid micropellets and its evaluation by differential scanning calorimetry and scanning electron microscopy. *Pharm Res* 1991; 8(Feb):178–184.
53. Eldem T, Speiser P, Hincal A. Optimization of spray-dried and -congealed lipid micropellets and characterization of the surface morphology by scanning electron microscopy. *Pharm Res* 1991; 8(1):47–54.
54. Mumenthaler M, Leuenberger H. Atmospheric spray-freeze drying: suitable alternative in freeze dry technology. *Int J Pharm* 1991; 72(27):97–110.
55. Sievers RE, Huang ETS, Villa JA, Kawamoto JK, Evans MM, BrauerPure PR. Low-temperature manufacturing of fine pharmaceutical powders with supercritical fluid aerosolization in a bubble dryer. *Appl Chem* 2001; 73(8):1299–1303.
56. Sievers RE, Karst U. Methods for fine particle formation. U.S. Patent 5,639,441, June 1997.
57. Sievers RE, Karst U. Methods and apparatus for fine particle formation. U.S. Patent 6,095,134, August 2000.
58. Sievers RE, Karst U, Milewski PD, Sellers SP, Miles BA, Schaefer JD, Stoldt CR, Xu CY. Formation of aqueous small droplet aerosols assisted by supercritical carbon dioxide. *Aerosol Sci Tech* 1999; 30:3–15.
59. U.S. Department of Health and Human Services, Food and Drug Administration, Center for Drug Evaluation and Research (CDER), Center for Veterinary Medicine (CVM), Office of Regulatory Affairs (ORA). Guidance for Industry: PAT—A Framework for Innovative Pharmaceutical Development, Manufacturing, and Quality Assurance, September 2004.

# 6

## Roller Compaction Technology

**Ronald W. Miller**

*Bristol-Myers Squibb Company, New Brunswick, New Jersey, U.S.A.*

### 1. INTRODUCTION

This chapter is different from the original; new works, findings, and best practices from various investigators since 1997 have been added. The interested reader will have to wait for a comprehensive book (in preparation now) to link numerous journal articles, chapters, and investigative works for technology completeness.

### 2. POWDER GRANULATION AND COMPACTION

Powder granulation is a process of powder size enlargement that incorporates small particles into larger ones. The definition of granulation comprises a range of different size enlargement methods that can be classified as either dry or wet. In wet methods, a suitable liquid is used to agglomerate the small powder particles into a mass. The wet mass is subsequently dried and sized for further downstream processing needs. Wet granulation methods have been the most widely used powder granulation technology in the production of pharmaceutical products, particularly in modern pharmaceutical manufacturing.

The chief reasons to granulate powders for the manufacture of pharmaceutical dosage forms are described by Kristensen and Schaefer (1):

- To improve powder flow properties for dosage filling and compression processes
- To eliminate wet granulation induced degradants and to improve product stability
- To prevent active product ingredient from segregating
- To reduce bulk volume, thereby minimizing storage and enhancing transport
- To reduce potential environmental and safety hazards.

Kristensen and Schaefer provide ample literature references in their chapter in the *Encyclopedia of Pharmaceutical Technology* about granulation size enlargement methods (1): Capes (2,3), Pietsch (4,5), Sherrington and Oliver (6), Kapur (7). Others referenced about wet granulation technologies are Kristensen and Schaefer (8), Lindberg (9), Fonner et al. (10), Anderson et al. (11), and Ghebre-Sellassie (12).

### 3. BACKGROUND

Granulation methods are used in the pharmaceutical industry to enlarge and densify small powder particles into larger ones typically to improve powder flow so that the material can be processed effectively and efficiently further into solid dosage forms. There are two methods of granulation, wet and dry. Wet granulation methods are widely described in the literature: *Encyclopedia of Pharmaceutical Technology (Granulations)* is solely devoted to this technology (1). Dry granulation operations do not use moisture or heat to process powders into densified granules. The pharmaceutical industry employs two methods of dry granulation: slugging and roller compaction. Little has been written about pharmaceutical dry granulation technology. Its contemporary use in the industry is  $\approx 50$ –60 years, beginning in the late 1940s. However, its popularity has risen in the last 15 years in parallel with the increased research on new efficacious active pharmaceutical ingredients (API) in the pharmaceutical industry. A number of these new API cannot be processed so easily using wet granulation and drying processing steps, because of their chemical fragility and sensitivity. Therefore, this pushes the need for the use of dry granulation processing techniques to advance new API in the 21st century.

Briefly, in dry pharmaceutical granulation processing, the powder particles are aggregated under high pressure, typically a pressure of 30–70 bar. Particulate matter can be aggregated when compressed at high pressure because of bonding forces developed by the direct contact between the solid surfaces. The high pressure serves to improve the contact area between the surfaces and thus the overall bonding strength. Sometimes a binding agent is needed to provide additional bonding strength.

In the pharmaceutical industry, dry granulation processing in the 1950s–1970s favored a process called slugging. This process design consisted of feeding powder into a large compression machine, such as a Stokes D3 type compression machine, where the powder was compressed into large tablets or slugs, typically in the order of 1 in. diameter with a tablet gauge of about 0.25 in. The tablet slugs were subsequently milled by a separate sizing machine to an appropriate particle size distribution, and further processed into pharmaceutical capsules, powder for oral suspensions, sachets, or tablet dosage forms. The slugging process is still used today by only a few manufacturing firms that have old pharmaceutical formulation processes. Today, modern pharmaceutical formulation processes introduced into the Americas, Western Europe, Australia, and parts of Asia do not use this kind of dry granulation equipment in newly developed formulations. The slugging process is a relic of the past in modern pharmaceutical technology; roller compaction is the key technology to future dry granulation processing.

Some characteristics are described briefly about the slugging process to complete the technology information for the reader. The slugging process is externally influenced by raw material feed properties such as powder cohesiveness, density, flow characteristics, and powder particle size distribution. The slugging machine's design characteristics such as machine type, feed hopper, feed frame, die diameter, tooling features, compression speed, and slugging pressure also influence the slugging process and the final product properties. In general, the key processing operational aspect of slugging is to maintain a uniform powder fill weight into the dies during the dynamics of the slugging process. This assures the best chance to manufacture uniform powder slugs and, ultimately, uniform densified granules. The compression–slugging setup is a key essential to maximizing the slugging throughput and minimizing the hopper feed-frame and die powder flow problems associated with

**Table 1** Disadvantages of Slugging

Single batch processing	Excessive air and sound pollution
Frequent maintenance changeover	Increased use of storage containers
Poor process control	Increased needs of manufacturing space
Poor economies of scale	Increase of logistics
Low manufacturing throughput per hour	More energy and time required to produce 1 kg of slugs than 1 kg of roller compact

*Source:* From Ref. 13.

the process. Slugging compression is normally performed at 4–6 tons hydraulic pressure, at a rate of 10–30 turret revolutions per minute. The specific machine tonnage, turret speed, and roll dwell time required for the process are dependent on the powder blend's physical properties, the tooling configuration, machine parts, and ultimately the slug specifications. Typical slugging machine output ranges from 30 to 50 kg/hr and the machines are not instrumented with modern devices to control their performance. There are many disadvantages with the slugging technology in the pharmaceutical industry (Table 1).

#### 4. BENEFITS OF ROLLER COMPACTION

This chapter briefly identifies key aspects of roller compaction technology. Unlike the slugging process technology, roller compaction technology is well suited for dry granulation agglomeration in the era of modern development of active pharmaceutical ingredients in pharmaceutical plants.

The increasing scale of manufacturing pharmaceutical products worldwide, the need for high processing rates, together with increased levels of good manufacturing practices, necessitate controlled dry granulation processes with as few processing steps as possible. This has been accomplished by instrumenting roller compactors to automate and control the mechanical process. Roller compaction technology plays a very important role in providing competitive cost control, safety, and quality products in the pharmaceutical industry. Key roller compaction benefits are identified in Table 2.

**Table 2** Advantages of Roller Compaction

Simplifies processing	Uses less raw materials
Facilitates powder flow	Eliminates water-induced degradants
Uses minimal energy to operate	Improves process cycle time
Requires less man-hours to operate	Prevents particle segregation
Improves drug dosage weight control	Facilitates continuous manufacturing
Reproduces consistent particle density	Improves content uniformity
Produces good tablet and capsule disintegration	Does not require explosion proof room/ equipment
Eliminates aqueous and solvent granulating	Produces a dry product that is process scaleable

*Source:* From Ref. 13.

## 5. COMPACTION THEORY

The bonding forces in a dry aggregate are important to granulation properties such as granule integrity, flowability, friability, density, compressibility, and size for downstream manufacturing process steps (1). Rumpf and coworkers described the bonding mechanisms occurring during dry granulation as a mixture of van der Waals forces, mechanical interlocking, and a recombination of bonds established between freshly created surfaces, and solid bridges, created because of partial melting and solidification during compression (14). A general theory describes particle bonding related to roller compaction in the *Handbook of Pharmaceutical Granulation Technology* (13). The process of dry granulation relies on interparticulate bond formation. Granule bond formation is characterized in different stages, which usually occur in the following order:

1. Particle rearrangement
2. Particle deformation
3. Particle fragmentation
4. Particle bonding.

Particle rearrangement occurs initially as powder particles begin filling void spaces. Air begins to leave the powder blend's interstitial spaces, and particles begin to move closer together. This action increases the powder blend's density. Particle shape and size are key factors in the rearrangement process. Spherical particles will tend to move less than particles of other shapes because of their close initial packing to one another. Particle deformation occurs as compression forces are increased. This deformation increases the points of contact between particles where bonding occurs and is described as plastic deformation (13).

Particle fragmentation follows as the next bonding stage. This occurs at increased compression force levels. At this stage, particle fracturing creates multiple new surface sites, additional contact points, and potential bonding sites. Particle bonding occurs when plastic deformation and fragmentation occur. It is generally accepted that bonding takes place at the molecular level, and that this is due to the effect of van der Waals forces (13).

When powder granules undergo an applied force or stress, a stress force is released from the granules. The granules attempt to return to their original shape or form; this is described as elastic deformation. A deformation that does not totally recover after the stress is released is a plastic deformation. Elastic and plastic deformations can occur simultaneously, but one effect usually predominates.

Parrott identified three theories of compression bonding: mechanical, intermolecular, and liquid-surface film. Mechanical bonding purports that individual particles undergo elastic, plastic, and brittle deformation. Bonding of this nature occurs because particle surfaces intertwine, forming mechanical bonds. Intermolecular theory identifies that there are some unsatisfied surface ions that have a potential need to bond to one another. Under pressure, intermolecular forces become pushed together close enough so that van der Waals forces can act to consolidate particles. The liquid-surface film theory identifies that bonding occurs because of the existence of a thin liquid film. The thin liquid film is generated from pressure induced by the energy of compression. This mechanism acts as a bonding agent promoting mechanical strength and an enlarged particle (15). Very little information is written about this last theory.



Dehont et al. provided a simplified approach to roller compaction theory (16). They described that powder granules move through stages in the feed area. The material is drawn into the gap by rubbing against the roll surfaces. The densification that occurs in this area is particle rearrangement. At this stage, the speed of the powder is slower than the peripheral speed of the rollers. Figure 1 represents compactor rolls in the horizontal plain; powder is pushed vertically downward into the compaction area.

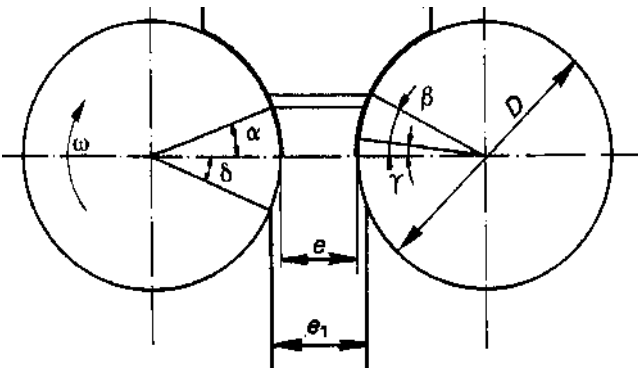
Note in Figure 1,  $\alpha$  = nip angle,  $\beta$  = material in volume space. The material is located in the compaction area between  $\alpha$  and the horizontal axis (Fig. 1). At this stage, the material undergoes additional compaction forces. The particles undergo plastic deformation and are bonded. Dehont's team noted that nip angle varies according to the material characteristics of particle size and density and the angle is about  $12^\circ$  (16). They defined the neutral angle,  $\gamma$ , which corresponds to the point where the pressure applied by the rollers is the greatest on the material. They also defined elastic deformation,  $\delta$ , and that occurs after the compact begins leaving the compression roll area. Compacted flakes may increase in size due to material elastic deformation and actually may have a larger thickness than the roll gap,  $e$  (16).

Dehont et al. developed Eq. 5.1 for the linear variation of flake thickness at a specific roll diameter (16):

$$e_1 = D(d_0/d_1 - d_0)(1 - \cos \alpha) \quad (5.1)$$

where  $e_1$  is flake thickness,  $D$  is roll diameter,  $d_0$  is material density at angle  $\alpha$ , and  $d_1$  is flake density. Dehont et al. assumed that the material in the compaction area remains horizontal and moves at the peripheral speed of the rollers. They also considered that the angle  $\alpha$  is independent of the roller diameter size and noted that the flake thickness  $e_1$  depends on the roller speed, the roller surface, and the compaction pressure. All these parameters influence the density of the flake  $d_1$ . Dehont et al. concluded that if the same flake thickness were obtained with different roller diameters, the flake density would be greater with larger-diameter rollers (16). This is due to the greater nip angle formed with the larger rolls allowing more material to be compacted.

R. W. Heckel considered the compaction of powders analogous to that of a first-order chemical reaction. The pores were the reactant and the densification of the material the product. The proportionality between the change of the density with the pressure and the pore fraction was the process kinetics (17). Heckel explained



**Figure 1** Front view of compactor rolls in horizontal plane. (From Ref. 16.)

mathematical constants that described the compaction behavior of a given powder and developed a mathematical relationship, Eq. 5.2 (17):

$$\ln(1/1 - D) = KP + \ln(1/1 - D_0) \quad (5.2)$$

where  $D$  is the relative powder density,  $D_0$  is the relative loose powder density at zero pressure,  $P$  is the pressure applied,  $1 - D$  is the pore fraction, and  $K$  is the proportionality constant.

The expression of density–pressure relationship permitted the determination of density values in the range of the pressures investigated. Heckel described mathematically that the curved region when plotting  $\ln(1/1 - D)$  vs.  $P$  is associated with powder densification (17). This occurred by a mechanism of individual particle movement in the absence of interparticle bonding. Heckel concluded that the densification represented by the linear region of the plot,  $\ln(1/1 - D)$  vs.  $P$ , occurred by plastic deformation of the compact after an appreciable amount of interparticle bonding had taken place. For quantitative reasons, Heckel, redefined the mathematical expression denoting a constant,  $A = \ln(1/1 - D_0)$ , which is quantitatively valid except at low pressures. He postulated that the constant  $A$ , which is somewhat larger than  $\ln(1/1 - D_0)$ , represents the degree of packing achieved at low pressures as a result of rearrangement processes before appreciable amounts of interparticle bonding take place (17). Heckel postulated that  $K$ , the slope of the linear region, is a measure of compact densification by plastic deformation.

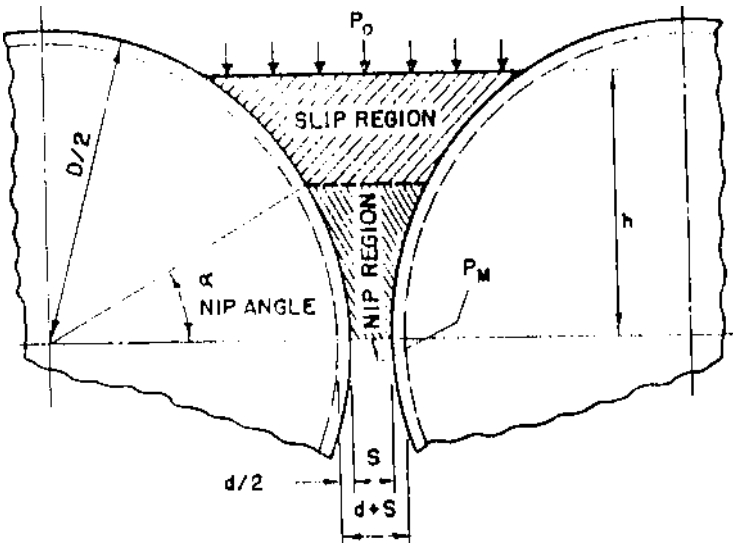
Heckel concluded that density–pressure data indicate that the rate of the change of density with pressure, any pressure, is proportional to the pore fraction in the compact at that pressure. Additionally, density–pressure curves may be described by two parameters. He theorized that one was related to low-pressure densification by interparticle motion. The second measured the ability of the compact to densify by plastic deformation after appreciable interparticle bonding.

J. R. Johanson identified, through very comprehensive mathematical models and relationships, material properties, press dimensions, and operating conditions for roll compactors. For more information, the interested person should read the entire reference (18). In part, he explained that roller compaction involves a continuous shear deformation of the granules into a solid mass.

To satisfy the theory's assumption, it was postulated that the material be isotropic, frictional, cohesive, and compressible. Figure 2 depicts material in a press that undergoes shear deformation into a solid mass (18). In Figure 2,  $P_o$  = horizontal pressure between rolls,  $\theta$  = angular position of roll bite,  $\alpha$  = nip angle,  $2d$  = roll diameter  $D$ ,  $h$  = height above the roll centerline at which feed pressure  $P_o$  is applied,  $P_m$  = horizontal pressure at  $\theta = 0$ , and  $S$  = roll gap.

Johanson pointed out that no roller compactor theories at that time determined the angle of the nip and the bulk density at  $\theta = \alpha$ , except by actually rolling the granular solid in a roll press. He also provided a method to calculate the nip angle and the pressure distribution between the rolls. His calculations determined the pressure distribution above and in the nip area (18).

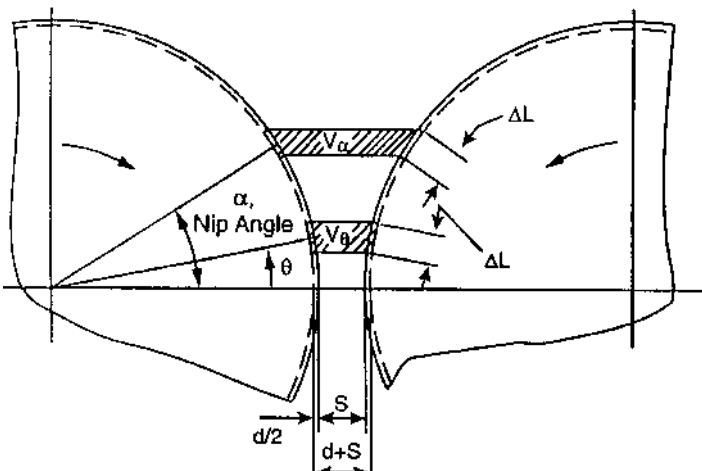
He provided the technical rationale to calculate the nip pressures in the nip region. He showed that material trapped in a volume  $V_\alpha$  between arc-length segments  $\Delta L$ , must be compressed to volume  $V_\theta$  between the same arc-length segments. The relationship requires that the bulk densities  $\gamma_\alpha$ ,  $\gamma_\theta$  in volumes  $V_\alpha$ ,  $V_\theta$  be related by Eq. 5.3 (Fig. 3) (18):



**Figure 2** Front view of compactor rolls in horizontal plane, depicting powder regions at different compaction forces. (From Ref. 18.)

$$\gamma_\alpha / \gamma_\theta = V_\theta / V_\alpha \tag{5.3}$$

In Figure 3,  $P_0$  = horizontal pressure between rolls,  $\theta$  = angular position of roll bite,  $\alpha$  = nip angle,  $2d$  = roll diameter  $D$ ,  $h$  = height above the roll center line at which feed pressure  $P_0$  is applied,  $P_m$  = horizontal pressure at  $\theta = 0$ ,  $S$  = roll gap,  $\Delta L$  = arc-length segments,  $V_\alpha$  = material trapped in volume space described by arc-lengths,  $V_\theta$  = compressed volume space described by arc-lengths,  $\gamma_\alpha$  and  $\gamma_\theta$  = respective powder bulk densities in volume spaces  $V_\alpha$  and  $V_\theta$ , and  $K$  = a material property constant for a given moisture content, temperature and time of compaction. Johanson stated that the pressure  $\sigma_\theta$  at any  $\theta < \alpha$  can be determined as a



**Figure 3** Front view of compactor rolls, depicting nip angle. (From Ref. 18.)

function of the pressure  $\sigma_z$ , at  $\theta = \alpha$ , by the pressure–density relationship. It was understood that, for increasing pressures, log density was a linear function of log pressure (19).

Johanson found that the nip angle does not depend on the magnitude of the roll force or the roll diameter. He demonstrated that the nip angle was affected very little by the geometry of the press or the cut grooves on the roll surface. It was mostly influenced by the nature of the materials that were compressed. The very compressible materials, with small  $K$ -values, had very large nip angles. On the other hand, incompressible materials, with large  $K$ -values, had very small nip angles. Ultimately, Johanson's results showed that material properties determine the maximum pressure that a roller press applies to material.

Parrott evaluated compacting of several pharmaceutical powders into compact sheets that were sized by an oscillating granulator into granules. He studied flake thickness, bulk and tap densities, angle of repose, and flow rate after sizing. His work demonstrated that one could improve most granule densities but not necessarily improve granule flow properties (20). Nearly all particulate matter can be aggregated when compressed at high pressure. In some cases, pressure alone cannot achieve sufficient bonding strength; therefore, a binding agent is required to be added to the powder blend (1). Polymeric binders added to mixtures at certain percentages form highly viscous bridges between particle-to-particle powders. When the polymeric mixtures are compressed, they increase the overall compact strength and enhance particle-to-particle bonding and can improve powder flowability.

Pietsch described a compaction capacity throughput equation for a roller compactor using flat rolls. The equipment capacity equation is theoretical in nature; it assumes that all compact is 100% usable for downstream processing needs. Compact capacity throughput,  $C_c$ , can be determined by Eq. 5.4 (4):

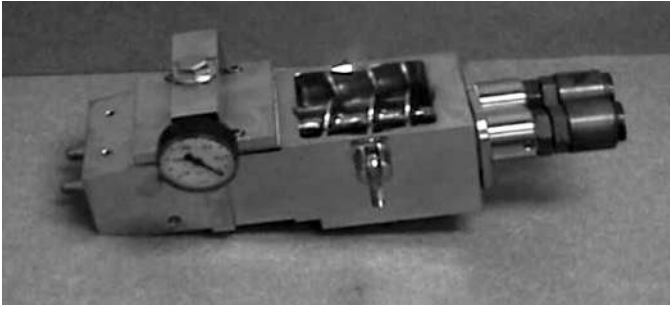
$$C_c = \pi D l h_A n 60 \gamma \quad (5.4)$$

where  $C_c$  is the roller compactor throughput (kg/hr),  $D$  is the roller diameter (cm),  $l$  is the roller length, working width (cm),  $h_A$  is the gap width between the rollers, sheet thickness (cm),  $n$  is the number of revolutions per minute (1/min), and  $\gamma$  is the apparent sheet density (kg/cm<sup>3</sup>).

## 6. DESIGN FEATURES OF ROLLER COMPACTORS

Certainly, a key enhancement that highlights today's pharmaceutical industry state-of-the-art roller compactors is programmable logic controllers (PLCs). They are used to control and monitor mechanical parts that regulate screw feed rate, roll speed, pressure and gap, vacuum deaeration, and mill speed. This section will not discuss PLC designs.

Briefly, a key machine innovation, vacuum deaeration, was a new important feature design added by some roller compactor vendors in the early mid-1990s. The design feature has been shown to help premodify raw material density prior to compacting and increase throughput (21). Other equipment features such as multiple horizontal or angled feed screws have assisted in manufacturing a uniform raw material feed across the rolls (21,22). Newly designed roll machine blocks, featuring cantilever roll systems, offer more efficient ways to clean, handle, and facilitate product and equipment changeovers. New storage hoppers and various screw feeder designs have improved delivery of poor flow powder to the rolls.



**Figure 4** Twin horizontal feed screw system with vacuum deaeration system. (Courtesy of Alexanderwek Inc., USA.)

A history of hopper and feed screw designs showed that each design evolved to facilitate and improve powder flow to the compactor feed screw conveyance system. Feed hopper designs shown in *Roller Compaction Technology for the Pharmaceutical Industry* depict designs used in older compactor models (23). Dehont et al. described the powder compaction feeding systems that were in use up to 1989 (24).

Specific hopper designs were used when material had good rheological characteristics. Materials that had good but unique flows, and needed to be evenly distributed across the roll-surface, such as granular salts, used hoppers that had guiding flaps. When the powder material had poor rheological characteristics, a vertical flap distribution box was fitted under the hopper. It primarily was used when compacting ores. Force feeder designs are more commonly used in the pharmaceutical industry. They are employed with various configured designs and shapes to supply poorly flowing powder to the nip roll region (23). Pietsch described modern feed screw system designs; depicting a vertical force-feeding screw with a slightly tapered end, an inclined feed screw, a vertical, tapered, and blade-angled feed screw, and a horizontal (single or dual) straight feeder screw(s). These designs are described and pictured (25). Innovatively designed feed screw systems are used commercially in roller compactors worldwide. An example is shown in Figure 4.

Sizing devices are now trimly fitted to the compactor body and controlled by variable speed drives. Most compactors no longer require a separate milling machine in tandem to size compacts as required by slugging technology. Roller compactors have clean-in-place systems that offer environmental and safety features. These systems minimize human exposure to chemicals. See *Roller Compaction Technology for the Pharmaceutical Industry* for additional information (23).

## 7. ROLL CONFIGURATION

Compactor design features have evolved over the years. By the mid-1970s, research revealed a number of roll design improvements that increased compacting efficiency. Three key conditions were identified, at that time, which optimized the roll compact throughput and minimized leakage of noncompact powder (26):

- Adequate powder supply must enter the gripping zone,
- Powder must be conveyed fully into the narrowest part of the roller gap,
- Compaction pressure must be distributed as uniformly as possible across the whole roller-gripped powder mass.

Equipment engineers and researchers worked on improving feeding equipment systems and roll designs to satisfy and maximize the above conditions. Some of the key advances are identified in Ref. 21 and are re-emphasized in this chapter.

Because of powder feed variability at the nip and in the roll gap regions, powder leakage is produced during the compaction process. This situation produces excessive fines and possible undesirable processed material. Usually, this problem is caused by uneven powder flow and compact formed when the powder is fed toward the middle of the roll width. Granules produced under these conditions are typically not optimal for further pharmaceutical processing.

Trials performed by Funakoshi et al. using rectangular aperture chutes, fitted at the end of a feed screw, aided in preventing uneven powder flow across the roll width. Funakoshi's team demonstrated the positive effects of having a concavo-convex roller pair fitted with inner ring walls. This feature counteracted side seal effects (fractured or incomplete compacted edges). They also designed and tested other rolls (concavo-convex with rim), which allowed the powder to distribute more uniformly across the roll width. This design reportedly minimized powder leakage during compaction (26). Funakoshi's team also showed that when the roll rim inner angle is zero the powder is not adequately and uniformly delivered to the gripping and compacting zones. This occurred because the stationary side seals acted as resistors to the powder flow (26). Their work demonstrated that the formed compact and the compaction pressure (using standard rolls) produced an uneven compact across the roller ends because of side seal friction. When they employed the newly designed concavo-convex rimmed rolls, it protected the compact from the adverse side seal fracturing effect. Funakoshi et al. also determined a proper selection of rimmed rollers, which delivered adequate powder to the compaction zone and also conveyed powder fully across the roller gap region. They concluded that the height and slope of the inner walls' rims optimally influenced the side seal effect. A 65° inner wall slope produced 2.5–3.0% fines' leakage during the compaction of lactose. When the rolls had no inner wall rims, the fines' leakage was 15%. In summary, the team optimized the compact and pressure distribution along the rolls by using the concavo-convex rimmed shaped rolls and found the best roll design was still dependent on raw material properties (26).

Parrott further substantiated the usefulness of the rimmed concavo-convex roller pair to increase the density of several pharmaceutical powders. His work resulted in optimizing a process with an uncompacted leakage rate of 5%. The optimization depended on the physical properties of the powder and the machine operating conditions such as the roller gap, feed screw speed, and roll speed (27). Some of their key design feature findings are summarized:

- Installing a concavo-convex roll surface rather than a flat roller pair
- Installing rectangular feed chute and flaps
- Designing cylindrical, conical/cylindrical, or tapered variable speed auger feed screws
- Optimizing the roll rim angle to 65°
- Installing digital and analog variable feed screw controllers
- Developing horizontal and variable screw feed systems.

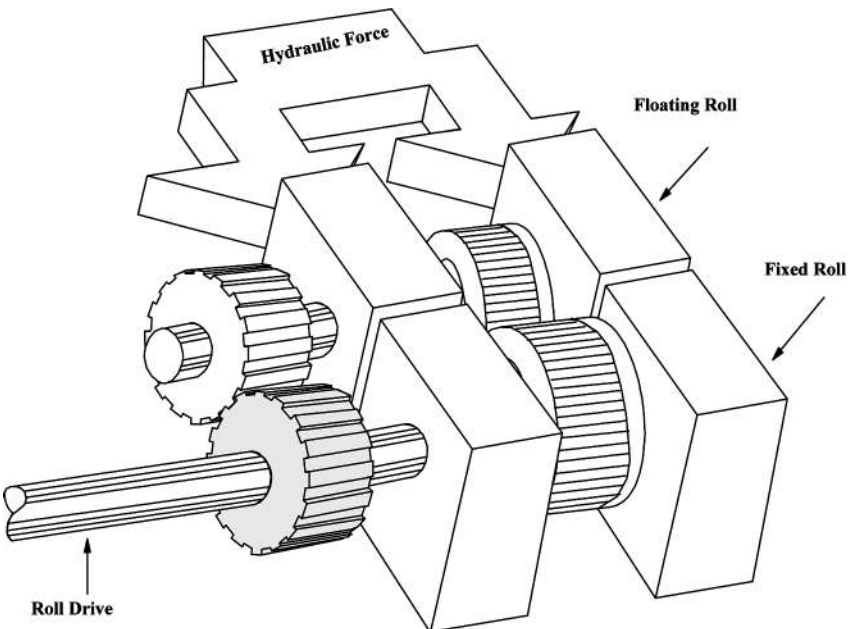
Jerome et al. in the 1980s studied the effects of compactor adjustments on powder blend properties. His team's research showed that pressure applied by the movable roller is not a predominant factor. They found that the most important variable was the compactor feed screw in relation to the roll speed. More will be said about this

point later in the chapter. Jerome correlated improved tablet compression hardness to the feed screw speed in relation to the speed of the rolls (28). Roll configurations are well documented (23). Most compactors now have one floating roll and one fixed roll each on separate bearing blocks and this is illustrated in Figure 5. Currently, one pharmaceutical manufacturer of roller compactor equipment has a fixed roll-pair system. This roll design system relies on powder gravity feed and a specially designed compression feed screw to continuously deliver powder to the fixed roll pair (23).

Pietsch described two pairs of rollers with different diameters  $D_1$  and  $D_2$ , with identical roll gaps  $h_A$ . He theorized that if the peripheral speed of both pairs of rollers is the same, roller compaction takes place more gradually in the case of the larger roll pair. At the same time, the larger-diameter roll pair pulls a larger powder volume into the nip region, resulting in a higher-density compacted product. The larger-diameter roll pair also minimizes air entrainment more efficiently than the smaller-diameter roll pair when both are operating at the same peripheral speed (25). Pietsch noted that the peripheral roll speed and particulate powder speed are not equivalent in the entire compaction zone. Throughput does not increase proportionally with roll speed.

There are two effects that hinder throughput: starved conditions in the feed zone and too much squeezed air from the particle mass that flows upward and against the powder flow, reducing the supply of material to the nip area (25).

What is the optimum roll speed for a compaction process? What factors does the formulating scientist or process engineer need to consider to maximize compact quality and compaction throughput? Johanson (29) attempted to answer these questions by predicting roll-limiting speeds for briquetting presses. He developed mathematical expressions considering even the gas and liquid effects as they can theoretically be



**Figure 5** Fixed and floating roll pair. (From Ref. 13.)

squeezed from a solid mass. Solid properties, press dimensions, and operating conditions were evaluated to predict optimum roll speeds. The results necessary for a quality briquette are most critical for low-density fine particles. Johanson's work showed the relation between feed pressure and roll speed to essentially be proportional to the material's permeability (porosity). For example, when the initial powder was compacted, sized, and recompact, the bulk powder permeability increased; however, when the powder was compressed, the compression force decreased, and compactor feed pressure force requirement decreased significantly. Johanson (29) also demonstrated that if the compactor feed pressure is kept constant and the press speed is increased, the maximum pressure applied to the briquette decreases as the roll speed increases. As a result, the briquette density and strength decrease likewise. For additional information, the interested reader should peruse the reference list.

Sheskey and Hendren in 1999 studied the effect of roll surface configuration on the drug release and physical properties of a hydroxypropylmethyl cellulose (HPMC) matrix controlled-release dosage form (30). Smooth and axial-grooved roll surface designs were studied using a Vector Model TF-Mini roller compactor (Vector Corporation, Marion, IA). Their hypothesis was that the greater the depth of the concavity on the roll surface, the pressure exerted on the powder being compacted would not be as evenly displaced as with a smooth roll surface. Therefore, as with tablet tooling design, the top of the crown area of the compacted ribbon would theoretically be softer than the rest of the ribbon. However, the results of a particle size distribution test performed on milled ribbons generated using both smooth and axial-grooved roll pairs showed similarity between tested samples. In addition, results showed little difference in tablet crushing strength values between samples manufactured using either type (smooth, axial-grooved) of roll surface design. Drug release profiles of tablets prepared from roller compacted granulations using both roll surface configurations were also similar. It was noted that the authors did not measure product throughput rates to address the possibility of improved efficiency when using an axial-grooved roll pair vs. a smooth roll pair.

## 8. FEED SCREW DESIGN

The consistency and evenness of the powder feed into a roll pair determines to a large extent, how complete a compact is made and ultimately the success of a compaction process. Most roller compacting systems suffer the disadvantage of leakage, i.e., 20–30% powder particles (depending on the formulation) are not compacted. This primarily occurs because of uneven powder feed and powder slippage between individual loose particles and the roll surfaces. Under these conditions, it is usually necessary to recycle the uncompact powder or fines. Recycling a compaction process is a significant drawback because of additional capital expenditure, labor costs, and increased throughput time.

The chief objective of roller compaction is to consistently make an agglomerate of sufficient strength that meets the required density, granulometry, and powder flow specifications. The key operational goal in compacting is to maintain a pressure range on the feedstock, independent of the fluctuating powder granulometry and flow into the rolls, to maintain a consistent compact. The compaction process is managed by controlling the input material, the quantity per unit of time, the roll speed, and the roll gap. Allowing the roll gap to float unchecked could influence the production rate and the compact quality. Therefore, it is important to control



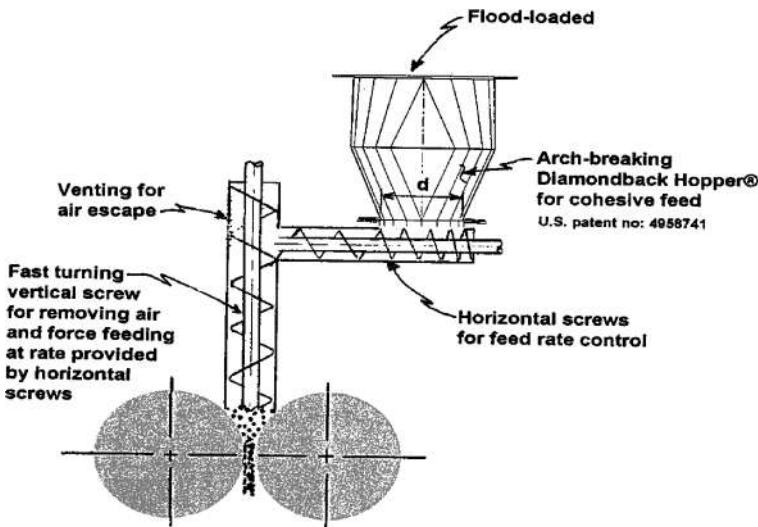
the compaction process by setting a constant powder feed rate during the compaction operation.

Design innovations on the powder feed input side of the roller compactor are complex. The complexity is double-edged: powder materials, which flow and move well, are more easily handled on the feed side of the compactor. These types of materials generally do not necessarily need significant densification to marginally improve their flow handling characteristics on a large scale. On the other hand, poor flowing and low-density powders require special equipment and considerations to feed a compactor. Additionally, it is necessary to maintain a constant powder flow and quantity of material to the rolls during the compaction process. Therefore, the delivery feed system plays a very important role in delivering poor flowing low-density bulk powder materials to the roll compactor.

Johanson, in 1995, described an arch-breaking hopper design that effectively delivered poor flowing powder from the hopper to a horizontal feed screw. The unique hopper design eliminated the “rat-holing” effect of poor flowing powders during hopper voiding and is described in Figure 6 (31).

Miller noted that the total compaction power requirement is the sum of the power required for the feed screw(s) and the roll drive (13). Feed screws not only convey the powder material from the compactor storage hopper but they also help deaerate the powder in the process. The deaeration of the powder acts as a minicompressor by precompacting the material just prior to roll compaction. Optimum compaction pressures and feed screw designs vary widely for different powder material properties. Changes in bulk powder density and feed screw speeds will affect the roll gap, the compaction pressure, the throughput, and the quality of the compact (13).

Weggel indicated that feed screw torque varies directly with the precompaction pressure (32). He suggested that by maintaining a constant feed screw pressure, the compactor operator can control the compact quality. Variations in precompaction pressure and in the compacting pressures are directly related to feed screw amperages and the roll drive motor. The compaction pressures are dependent on a continuous flow of powder into the feed screw area. If the powder feed flow is intermittent or



**Figure 6** Arch-breaking hopper design. (From Ref. 31.)

## Roller Compaction: Compacts

Roller Compactor Feed Screw Designs: Twin feed screw, Single feed screw

Compact color pattern  
twin feed screw with &  
without vacuum deaeration



Vacuum: 15 - 20 % fines  
No vacuum: 20 - 25 % fines

Compact color pattern  
single feed screw with &  
without vacuum deaeration



Vacuum: 20 - 25 % fines  
No vacuum: 20 - 25 % fines

**Figure 7** Roller compaction: compacts. (Courtesy of R.W. Miller.)

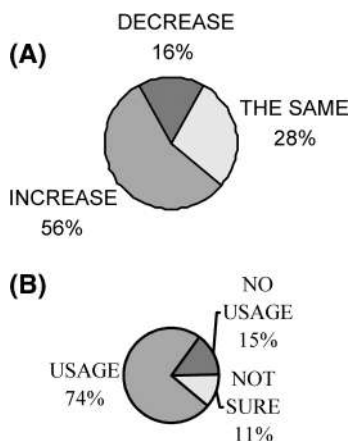
interrupted, this will affect the feed screw amperage readings and eventually the roll drive readings. Weggel noted that forcefeeding the material deaerated the feedstock and reduced the roll pressure loads. He found that it was more efficient to achieve maximum densification during several stages of the roller compaction process (32).

Miller noted, in 1996, that the design of vertical cylindrical feed screws appears to feed powder uniformly to the circumference of the feed screw (13). However, he concluded that the powder feeding to the rolls did not coincide with the general rectangular shape of the compactor throat. The observed drawback was that the powder did not get delivered evenly across the rolls; the middle of the rolls received more powder than the rolls' edge. This potentially created a poor quality compact; a strong middle compact that is weak at the ends because of frayed edges. Frayed compact edges give rise to uncompacted material and excess fines (13). An example of the phenomena was depicted when using a light yellow-green color feedstock, which after roller compaction using a twin feed screw system produced a homogenous colored compact. The same feedstock passed through a compactor designed with a single vertical feed screw, exhibited a sinusoidal colored compact (Fig. 7). Miller indicated that a multiple horizontal feed screw design system provided a more uniform powder distribution across the rolls in area and in volume than a single vertical feed screw system. This applied to either vertical or horizontal single feed screw systems (13).

## 9. FUTURE TRENDS IN GRANULATION TECHNOLOGY

A number of these attributes, best technology practices, and features were rated for their industrial and pharmaceutical importance and reported by Miller and Sheskey in 2001 (33). Survey findings evaluated future industry usage of roller compaction technology in technical operations and in research and development (Fig. 8).

Worldwide pharmaceutical manufacturing technical operations predict significantly increased roller compaction usage in the future. Research and development scientists indicated worldwide that they are currently involved with roller compac-



**Figure 8** (A) Roller compaction current usage in company technical operations. (From Ref. 33.) (B) Roller compaction current usage in R&D projects. (From Ref. 33.)

tion technology to develop new formulations. Some key reasons why this is the case is that most API discovered now are very sensitive to water and heat and have low bulk densities. The authors concluded that these combined factors push roller compaction technology to the forefront as the preferred processing technology for new pharmaceutical chemicals for solid-dose formulations in the pharmaceutical industry (33). It also appears that pharmaceutical companies are chiefly content to have the right technology in place to deliver the granulation form needed in the easiest, quickest, and most efficacious manner.

A significant survey response indicated the importance of both design and service features to advance roller compaction technology (33). There seems to be an assorted blend of needs that are due in part to vendor past performances, such as reliability, technical support programs, and service history. There is also a component of innovation, new technology advances, such as cantilevered rolls and operator touch screens with parametric feedback [Table 3, courtesy of the American Pharmaceutical Review (33)].

## 10. NEW FINDINGS

P. Guigon and O. Simon, Compiegne Universite de Technologie, Compiegne Cedex, France, recently presented experimental results using a laboratory Komarek<sup>®</sup> B100QC press (Fig. 9). They demonstrated that when using a single feed screw (without vacuum deaeration system), to feed a roll press, the stress exerted on the compact was neither homogenous on the roll width nor constant with time.

The heterogeneity was characterized by measuring light transmission through a sodium chloride compact. The team showed that the powder packing that took place in the last flight of the feed screw caused heterogenous feeding pressure. The heterogenous feeding pressure caused the heterogenous compact properties (34). The team developed a mathematical model to link feed screw geometry to the stress distribution in the compact. The author notes that this finding is contrary to

**Table 3** Preferences for Compactor Design and Service Features

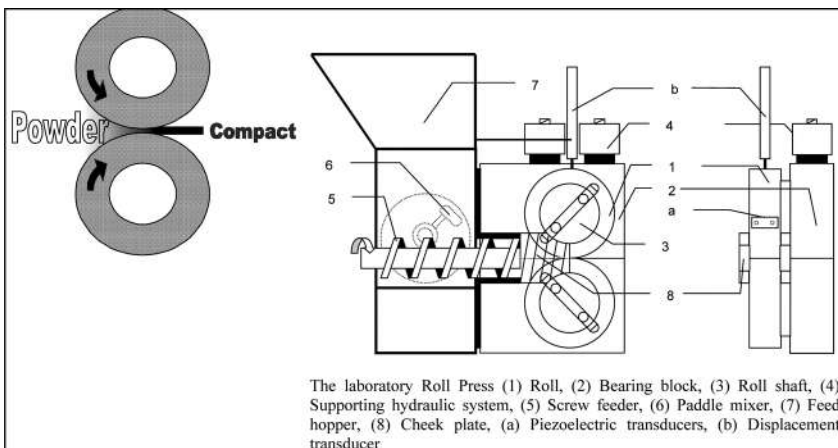
Compactor design and service features	Number of responses	Average rating
Machine performance and reliability	56	4.5
Vendor spare parts availability	55	4.2
Variety of model sizes	61	4.1
Vendor IQ and OQ program	51	3.9
Vendor service history	48	3.9
Cantilevered vs. double-bearing rolls	49	3.8
Vendor delivery time	54	3.8
Ease of cleaning	54	3.7
Variety of roll patterns	51	3.7
Vendor training support	54	3.5
Touch screens with parameter feedback	60	3.2
Other	11	3.2

Note: 5 = high, 1 = low preferences.

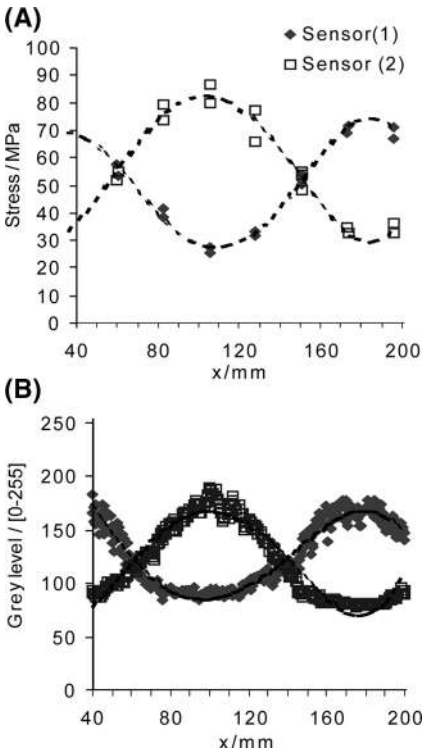
Source: From Ref. 33.

the Johanson model noted earlier in this chapter and quite revealing. The laboratory press was specially instrumented with two flush mounted piezoelectric transducers fitted on the smooth upper roll (130 mm diameter by 50 mm width). The transducers measured stress (0–200 MPa) exerted on the roll surface at 15 mm from both sides of the roll. The position of the piezoelectric transducers was defined once per revolution; the roll speed, screw feeder speed, and hydraulic pressure were also measured and recorded (Fig. 10).

The team measured the compact density by the distribution of light transmitted through the sodium chloride compact. Guigon indicated that the milled sodium chloride crystals were oriented by the applied stress and therefore the incident light was not diffused similarly in all directions (34). The stress applied on the compact is



**Figure 9** Side and front view of Komarek B100QC press used to determine geometry feed system and stress distribution and applied on compact. (From Ref. 34.)



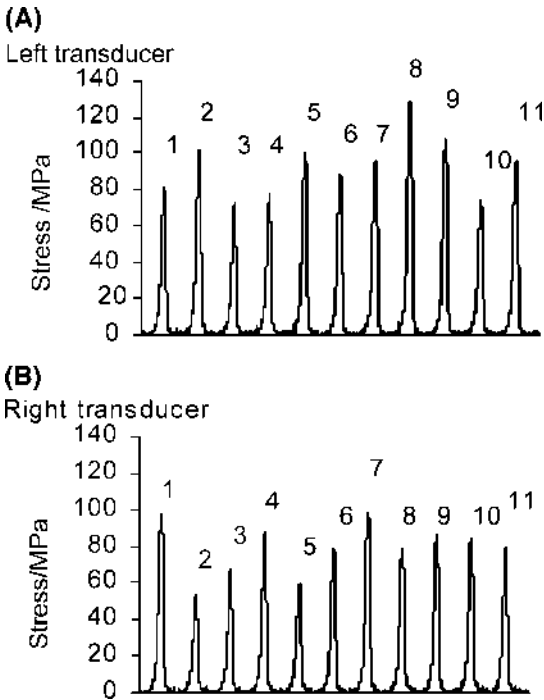
**Figure 10** (A) Applied stress on the compact during one rotation period of feed screw. (B) Corresponding gray level on the numerical image of light transmitted through the compact. Sodium chloride  $d_{50} = 74 \mu\text{m}$ ,  $V_r = 10 \text{ rpm}$ ,  $V_s = 25.3 \text{ rpm}$ . (From Ref. 34.)

neither homogenous on the roll width nor constant with time. Guigon points out that the stress maximum for the same sensor varies from one rotation to the next and comparing the left and right sensors, one has a low signal while the other has a high signal during each turn. He noted that the maximum stress measured for each roll revolution was a cycle of the time equal to the time period of the feed screw (Fig. 11).

Figure 12 shows a good representation of the heterogeneity of the applied stress, illustrating that the maximum stresses are not applied to the center of the roll but more toward the roll edges. The scientists showed that the applied stress on the compact in the roller gap is due to the feed pressure distribution from the feed screw. The nature of the feed pressure was due to the pushing of the powder in the last spiral of the feed screw. The team took many stress profile readings to measure the heterogeneity of the applied stress, as it was not constant or homogenous along the roller width (Fig. 12).

Graphically, the light transmitted through the salt compact and the maximum measured stresses (from the two locations on the roll) enabled the stress measurement throughout the compact in the gap. The compact zones that had endured less stress transmitted less light and therefore appeared darker (34).

Guigon sketched the feeding zone just prior to roll compaction (Fig. 13). He indicated that the feed screw exit pressure was a function of the geometry and surface

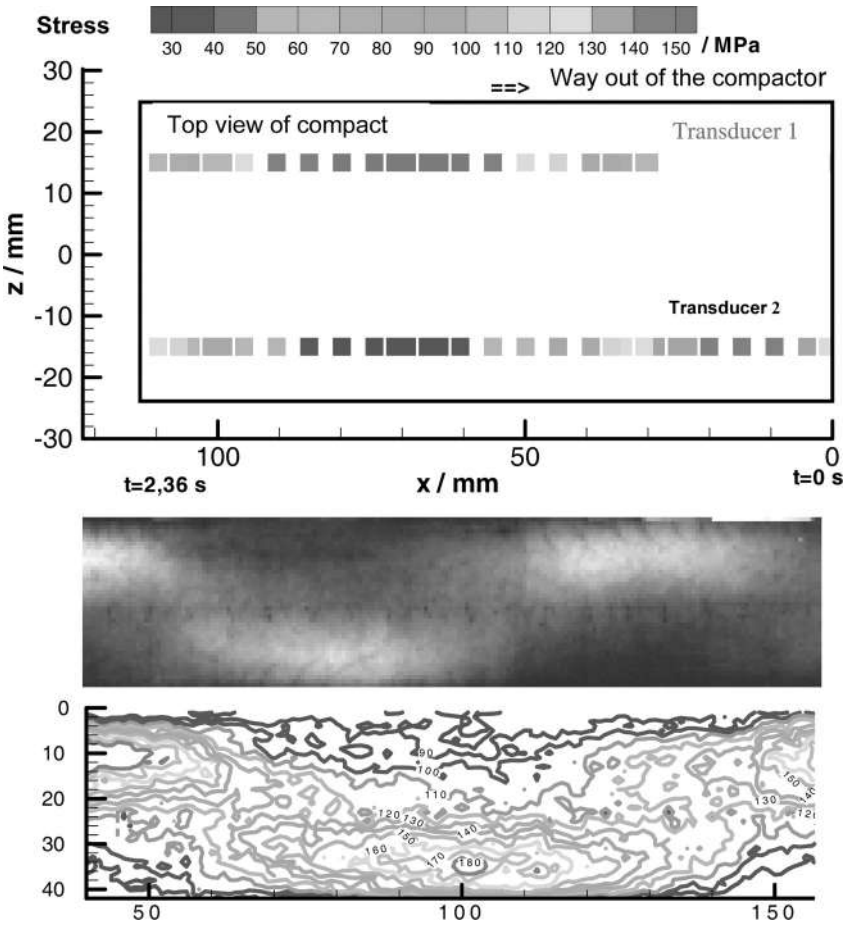


**Figure 11** Stress profiles recorded simultaneously on the (A) left and (B) right transducer vs. number of roller rotations during consecutive turns. (Screw speed,  $V_s$ ; roller speed,  $V_r$ ; sodium chloride ( $V_r = 8.4$  rpm,  $V_s = 22.3$  rpm). (From Ref. 34.)

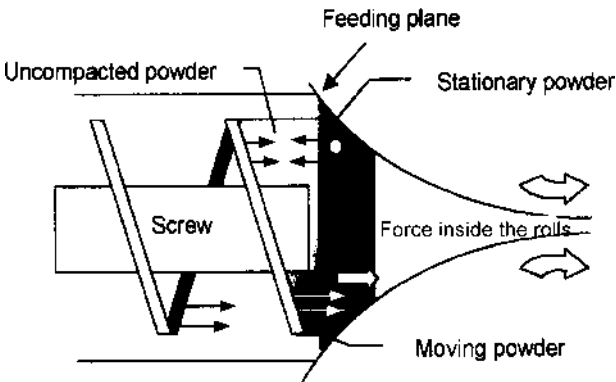
properties of the feed screw and of the compressibility of the powder. Summarizing his findings, the pressure at a location ( $y, z$  planes, perpendicular to the  $x$ -direction of motion) of the feeding plane will vary due to the motion of the last flight of the screw. When the wall of the screw flight is far from the feeding plane (top part of Fig. 13), the powder between the flight and the feeding plane is not compacted and the localized pressure at the feeding plane is low. When the flight at this location moves forward, the powder first compacts without moving significantly, increasing progressively its density and local pressure at the feeding plane.

The team proved the observation with two dynamic motion picture experiments. The first study showed the motion of particles at the check plate wall and confirmed by video analysis that the particles do not move continuously in the feed zone (34). Guigon noted that the powder particles are almost stationary. Then, the powder moves forward before stopping again. The velocity fluctuations have the same period as the screw. The second experiment consisted of using sodium chloride and pushing the material to the rolls by means of a piston-feeding device. The compact is shown in Figure 14 with light passing through it. Most notably, the densest part of the compact is through the center, where most of the light is transmitted.

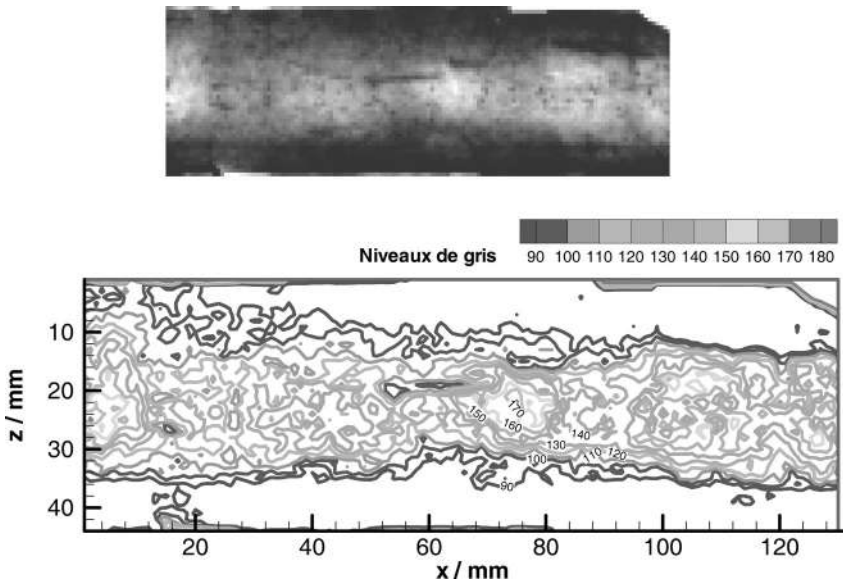
The work by Guigon and Simon provided new meaning to the importance of the feed screw pushing powder into the rolls and the feed screw design's influence on compact formation. The author of this chapter raises some questions on how a multiple feed screw system under vacuum deaeration environment would affect compact formation. No information has been published on investigating these aspects.



**Figure 12** Distribution of stresses applied to a compact during the dynamic state of roller compaction. (From Ref. 34.)



**Figure 13** Sketch of the feeding zone. (From Ref. 34.)

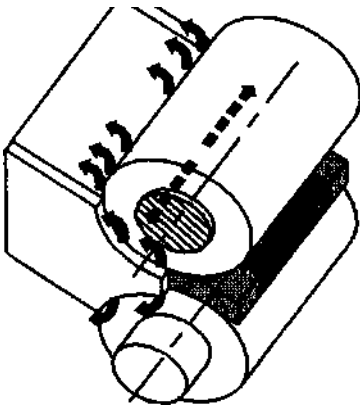


**Figure 14** Distribution of stresses applied to a compact, by piston pushed material into rolls, not feed-screw pushed. (From Ref. 34.)

## 11. DEAERATION THEORY

A key factor limiting compaction throughput and quality is air entrapment in powder materials. During compression, air-occupying voids between particles are compressed and squeezed. The gas pushes through the powder causing powder fluidization and a nonuniform level of powder at the roll gap. It is best described in Figure 15. This situation limits compact throughput and creates a nonuniform compact density. Air entrapment creates excess fines prior to sizing because of “spidering” compact edges.

The spidering condition occurs when gases rush across the inside of a compact to thinly and weakly formed flaked edges. The flake edges break apart perpendicular to the compaction direction. The compact edge breakage appears “saw tooth” in



**Figure 15** Pattern of gas escape from nip region. (From Ref. 36.)

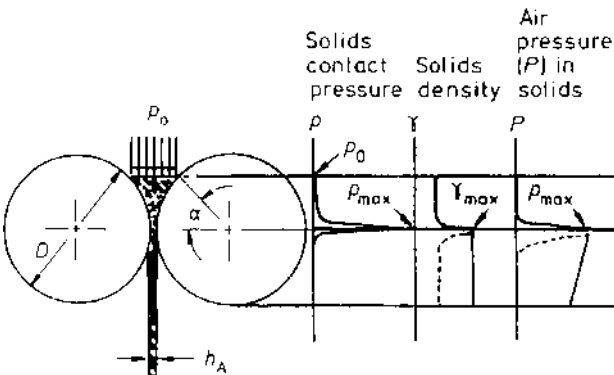


structure and varies in length depending on the nature of the powder binding properties, the amount of air entrainment, and the roll dwell time.

Johanson predicted theoretical compactor operating conditions to handle air entrainment effects in materials. In general, he concluded that the critical compacting pressure level is dependent on a number of factors: roll diameter and speed, powder permeability, compressibility, and compact strength. Johanson indicated, when applying these principles in commercial application, that a compactor operator would have to operate the press at slightly less than maximum pressures to allow for material inconsistencies and variable in-feed flow rates (35).

Johanson and Pietsch described the forces at work in a roll press when powders are compacted (25,35,36). Johanson illustrated the three typical work phases during compaction Figure 16. The first region is the initial solids contact pressure with the feed screw. Pressure at this point is nil,  $P_0$ . Later, as the solids begin to get pushed and gripped by the rolls, pressure continues to build. Ultimately, the solids are moved into the narrowest point of the nip angle where the maximum pressure occurs at  $p_{max}$ . The second region describes the solid's density increase through compaction and densification occurs rapidly, in less than a second. Some materials have properties that after discharge from the compactor undergo elastic deformation, which can reduce the compact's density, expressed by the dotted curve. The third region of force at work is air pressure. Models such as the one described take into account that it is dependent on the porosity of the particulate solids compacted. If the porosity of the compacted material remains high enough during the compaction process, air pressure can escape and vent during and after compaction. On the other hand, if the material has low porosity, air pressure builds up to high levels because it cannot escape easily. This can be seen in several ways, one of which is through expansion of the compact bursting. Bursting can be associated with a popping sound when operating the compactor. The second way occurs when the compacted sheet breaks into slivers or "spidering" at the compact edges.

Both Johanson and Pietsch reported that expanding gas in a compact is detrimental to the compaction process: by reducing the compaction throughput and increasing the amount of fine particles. Johanson illustrates the effects of roll speed and powder porosity on air pressure in a compacted sheet (43). He shows a relative large roll speed operating range when compacting a permeable (porous) powder. Air entrainment does not limit roller speed for coarse granular powders. On the other



**Figure 16** Compaction work phases. (From Ref. 43.)

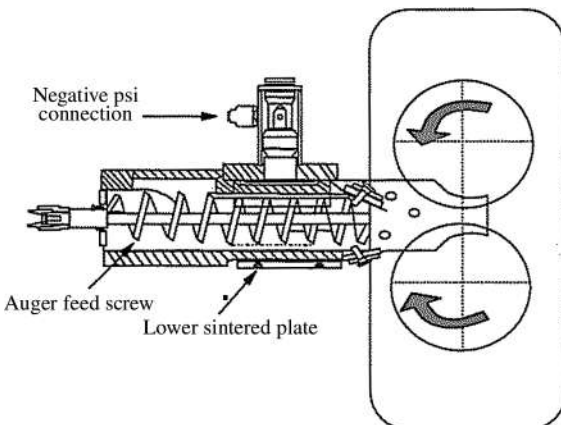
hand, when compacting very fine powders, the operating roll speed range is significantly reduced because of air entrainment.

Miller indicated that the evenness of the powder feed into the rolls determines, to a large extent, the success of compaction. Roller compactor systems suffer from two disadvantages: as the powder feed bulk density approaches  $0.3 \text{ g/cm}^3$  or less, the compaction throughput efficiency decreases. Secondly and concurrently, the uncompacted powder leakage generally increases around the rolls (21). Miller, in 1994, described a new machine design improvement that used vacuum deaeration to remove air entrainment from the powder just prior to the nip angle during roller compaction. The multiple benefits of such action are significant when compacting low-density raw materials (21):

- More uniform powder feed to the rollers
- Less voltage and amperage variability for the roll pair
- More uniform and strong compact
- Less powder leakage
- Greater yield
- Less powder adhering to the compact prior to sizing
- Higher compact throughput
- Less airborne particles.

The newly designed equipment involved a compactor fitted with two horizontal feed screws, which featured vacuum deaeration. Specifically, the roller compactor was equipped with a conical storage hopper containing a variable speed agitator. Bulk powder was fed directly from the top of the hopper to the top of twin horizontal auger feed screws, which directly transported the powder to the nip roll area (13). Top and side views of the design features are shown in Figure 17 .

A novel stainless steel encasing that leads to the compactor rolls encloses the variable-speed auger screws. Just before the nip area, a pair of sintered stainless steel segments are assembled within the horizontal auger feed system, which can operate under partial vacuum. A small, self-contained vacuum pump draws negative pressure through a dry filter and a stainless steel line connected to the sintered assembly plates. The partial vacuum is adjustable from  $-0.1$  to  $0.8$  bars. The compaction rolls



**Figure 17** Compactor side view of auger feed screw system and sintered plate segment. (From Ref. 13.)

operate at different speeds and are supported on heavy-duty bearings in such a way that the lower roll is fixed and the upper roll is slightly movable in the vertical plane. The deaerated material passes through the roll pair, which is under infinitely variable hydraulic pressure. The deaeration, auger feed screws' design and speed, roll speed, and hydraulic roll pressures are the main factors in producing a compact with specified properties.

In several experiments, Miller studied the effects of using horizontal twin auger feed screws under partial vacuum (Alexanderwerk Inc. Horsham, PA, USA, model 50/75 compactor). The feed powder was vacuum deaerated just before roller compaction. The experimental design showed that the compactor's deaeration feed system significantly increased compaction output and minimized powder leakage when compacting very low-density blends ( $<0.35 \text{ g/cm}^3$ ); remarkable results were observed (22).

To evaluate the effectiveness of the compactor's deaeration system, a test was designed to process a low-density active drug blend with and without the activated deaeration system. The test showed how much material was compacted with the deaeration system engaged and how much material was compacted when it was not engaged. The test also determined how much material was not compacted (powder roll leakage) in each case. Details of the experimental plan are found in Ref. 38. Results of this experiment showed that under the influence of vacuum deaeration, the compactor produced throughputs of 100 kg/hr and the resultant noncompacted material leakage rate was  $<2\%$ . The vacuum deaeration was so effective that there was no need to recirculate the noncompacted powder back to the rolls to meet processing specifications. Under a second set of compacting conditions, vacuum deaeration was not activated and the process typically produced 70–80 kg/hr of densified compact. The powder leakage rate increased to 20–30%. During this set of conditions, the powder flow to the roll pair was uneven and the ribbon compact was not uniform. Processing this formulation for a long period of time under these conditions would have required recirculation equipment to return the uncompact powder to the rolls for further processing (21,37,38). [Table 4](#) for compactor parameters (trials 1 and 2).

In several other trials, Miller also studied the effects of using two different compactor's vacuum deaeration systems ([Table 5](#)). The tests, similar to the ones previously described, were carried out using differently designed compactors. The objective of these trials was to increase the active bulk density of the feedstock from 0.22 to 0.61  $\text{g/cm}^3$  (13). Miller reported that the compactor, machine 1, containing the horizontal twin screws and the vacuum deaeration design as described in [Figure 17](#), produced granules with 0.63–0.64  $\text{g/cm}^3$  density at 80 kg/hr yield. When the vacuum deaeration was not activated the desired granule density specification could not be achieved. [Table 6](#) (trials 1 and 2) for operating parameters and results.

A second compactor, machine design 2 ([Fig. 18](#)), did not densify the active drug granules during the first compaction run when employing vacuum deaeration. After a second compaction pass with vacuum deaeration, trial 2, the powder density was increased slightly to 0.58  $\text{g/cm}^3$ . It appeared that the level of vacuum being applied to the active drug substance, in machine 2, was insufficient, ineffective, or not optimally positioned, even at its maximum vacuum deaeration level (13). [Table 7](#) (trials 1–3) for machine 2 operating parameters and results.

Miller's experiments evaluated the effects of powder density; screw feed speed, roll speed, roll pressure, vacuum deaeration pressure, compaction rate, and the compaction leakage rate. Test results demonstrated that the first compactor's deaeration and feed system designs significantly increased compaction output. The new equip-

**Table 4** Compactor Operating Conditions and Yields for Poor Following Low-Density Active Drug Blend, Formulation 1, Vacuum Deaeration and Non Vacuum Deaeration Trials

Formulation 1 Conditions	Trial 1	Trial 2
Powder density (g/cm <sup>3</sup> )	0.25–0.35	0.25–0.35
Screw feed (rpm)	52	52
Roll speed (rpm)	8	8
Vacuum (bar)	–(0.78–0.78)	0
Roll pressure (bar)	60–65	60–65
Compact rate (kg/hr)	100	70–80
Compact leakage rate (kg/hr)	2	15–20

Source: From Ref. 13.

ment design and process provided high compact yields and virtually eliminated powder leakage, obviating the need for expensive powder recirculation equipment. The first compactor's vacuum deaeration design (Fig. 17) proved to be superior to that of the second machine (Fig. 18) when compacting an active bulk drug with a density of approximately 0.2 g/cm<sup>3</sup>. In summary, a new critical condition, vacuum deaeration, had been identified in optimizing roller compacting effectiveness and efficiency (13). Miller concluded that four key processing conditions must exist to optimize roller compaction throughput and minimize powder leakage around the rolls (13):

- Adequate powder supply must enter the gripping zone.
- Powder must be fully conveyed into the narrowest part of the roller gap.
- Compaction pressure must be distributed as uniformly as possible over the whole of the roller-gripped powder mass.
- Sufficient vacuum deaeration must be effectively distributed prior to the nip roll region, particularly for low bulk density powder feed stock.

## 12. ROLLER COMPACTION AND NEAR-INFRARED SPECTROSCOPY

Work by this author in the mid-1990s investigated roller compaction and near-infrared spectroscopy (NIRS) technology, by examining three different active ingredient

**Table 5** Compactor Operating Conditions and Yields for Poor Flowing Low-Density Active Drug Blend, Formulation 2, Vacuum Deaeration and Non-vacuum Deaeration Trials

Formulation 2 Conditions	Trial 1	Trial 2
Powder density (g/cm <sup>3</sup> )	0.25–0.35	0.25–0.35
Screw feed (rpm)	52	52
Roll speed (rpm)	8	8
Vacuum (bar)	–(0.78–0.78)	0
Roll pressure (bar)	60–65	60–65
Compact rate (kg/hr)	150	100–110
Compact leakage rate (kg/hr)	1.3	20–30

Source: From Ref. 13.

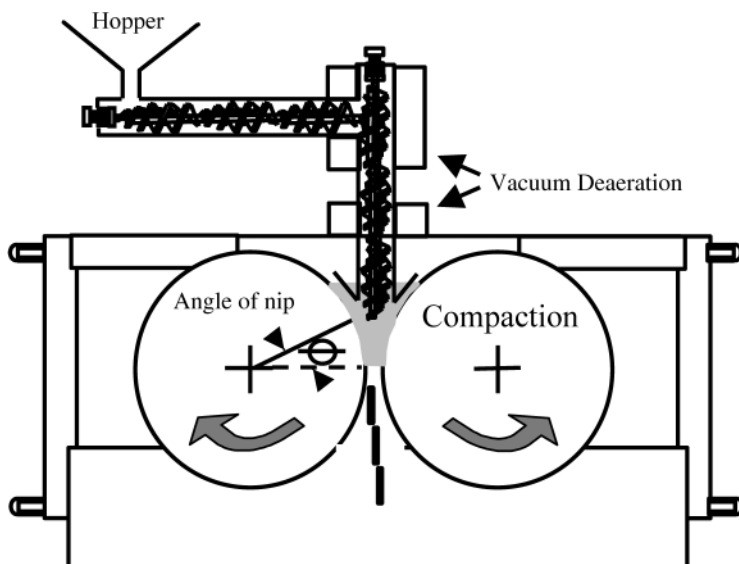
**Table 6** Operating Parameters and Results of Compactor Machine Design 1 When Compacting Poor Flowing Low-Density Active Drug Substance Blends

Conditions	Trial 1	Trial 2
Initial density ( $\text{g}/\text{cm}^3$ )	0.22	0.22
Powder density ( $\text{g}/\text{cm}^3$ )	0.63–64	0.45
Screw feed (rpm)	52	52
Roll speed (rpm)	8	8
Vacuum (bar)	0.65	0
Roll pressure (bar)	50	50
Compact rate ( $\text{kg}/\text{hr}$ )	80	42

Source: From Ref. 13.

blends subjected to different compaction conditions and mapped specific in-process roller compaction processing steps and relationships. Miller illustrated the use of NIRS to map, in the static mode, roller compaction unit operations. This was the first published work about using any spectroscopy to map roller compaction processing steps (39).

Blends were compacted using an Alexanderwerk roller compactor, model WP50/75N (Alexanderwerk Inc., Horsham, PA) fitted with vacuum deaeration. All compacts were sized through a continuous series double rotary granulator fitted with 3.15 and 1.25 mm mesh screens, respectively. Blends were finally mixed for 2 min and compressed into tablets using a Kilian E 150 press (Kilian & Co Inc., Horsham, PA), which was equipped with standard concave 11 mm diameter tooling. NIR spectral analysis was conducted using a Rapid Content Analyzer, model 6500 NIR spectrophotometer (Foss NIRSystems, Silver Spring, MD). NIRS libraries were developed for each active drug concentration and the specific



**Figure 18** Compactor front view of vertical feed screw system with vacuum deaeration. (From Ref. 13.)

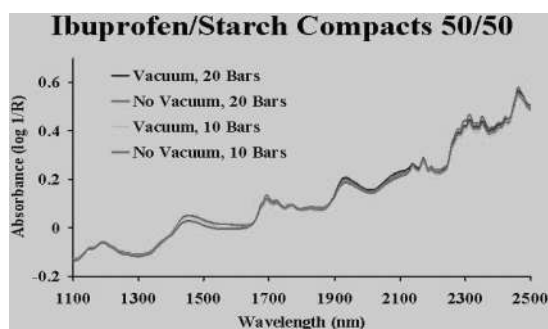
**Table 7** Operating Parameters and Results of Compactor Machine Design 2 When Compacting a Poor Flowing Low-Density Active Drug

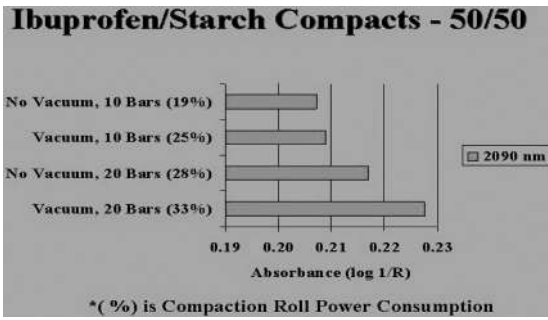
Conditions	Trial 1	Trial 2	Trial 3
Initial density (g/cm <sup>3</sup> )	0.22	0.45	0.22
Powder density (g/cm <sup>3</sup> )	0.45	0.58	0.46
Screw feed (horizontal) (rpm)	30	30	30
Screw feed (vertical) (rpm)	260	260	260
Roll speed (rpm)	6	6	6
Vacuum (bar)	0.34	0.34	0
Roll pressure (bar)	50	50	50
Compact rate (kg/hr)	40	48	36

Source: From Ref. 13.

compactor's process critical control point's (PCCP's) operating conditions, details of the experimental plan are referenced (39).

The NIRS absorbance shows (optical density) differences between 10 and 20 bar roll pressure compacts and also differences between compacts manufactured with and without vacuum deaeration (Fig. 19). The associated NIR ibuprofen/starch compact spectra also show an absorbance (optical density) hierarchy. The higher the roll pressure with vacuum deaeration the greater the NIR optical density (10 bar, no vacuum < 10 bar, vacuum < 20 bar, no vacuum < 20 bar, vacuum). Figure 20 further illustrates the NIRS ibuprofen/starch 50/50-compaction evaluation. Figure 20 compares the two levels of roll pressure with and without vacuum deaeration to a third parameter, compaction roll power consumption (CRPC). CRPC is a power force measured from the roll drive that is continuously monitored throughout the compaction operating process. An ibuprofen/starch compact trend analysis shows that the greater the roll pressure with vacuum deaeration the greater the CRPC (10 bar, no vacuum < 10 bar, vacuum < 20 bar, no vacuum < 20 bar, vacuum). The analysis demonstrates that employing vacuum deaeration increased the CRPC at both low and high roll pressure levels. As the vacuum deaeration increased, the width and gauge of the ibuprofen/starch powder compacts also increased. Additional characterizations for aspirin/starch and acetaminophen/starch compacts were completed, Ref. 39.

**Figure 19** NIR absorbance processing 50/50 Ibuprofen/Starch compacts. (From Ref. 39.)

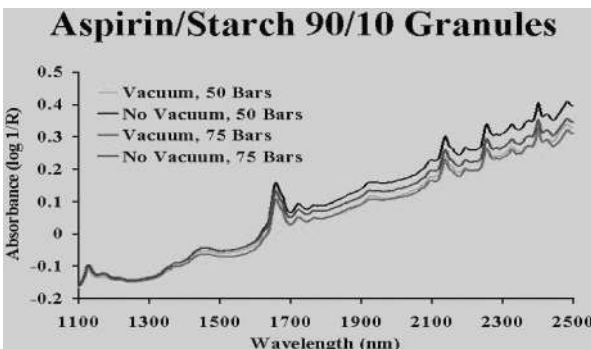


**Figure 20** 50/50 Ibuprofen/Starch compacts CRPC compactor and NIR corresponding values. (From Ref. 39.)

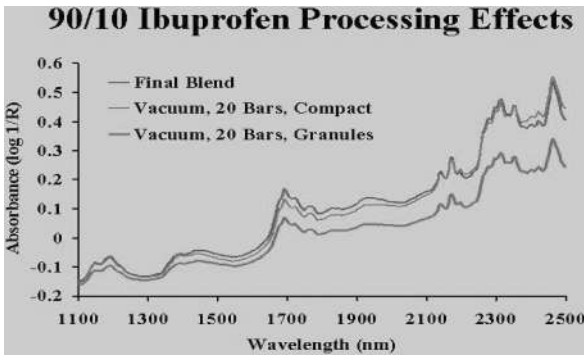
Figure 21 depicts granule NIRS sensitivity to vacuum deaeration and roll pressure sized compacts. In general, granules produced from sized compacts manufactured without vacuum deaeration and at lower roll pressure levels exhibited higher optical density. NIR spectra of 90/10 ibuprofen-processing effects are shown in Figure 22: final blend, compact 20 bar roll pressure (vacuum deaeration) and granules made from the same corresponding conditions. The results demonstrated that successive ibuprofen/starch processing steps, compacting, and sizing produced uniquely different NIR absorbance amplitudes.

### 13. ROLLER COMPACTION AND PAT

A new FDA guideline initiative (2003–2004), Process Analytical Technologies (PAT) encourages manufacturers to use real time in-line, on-line, or at-line nondestructive sensory technologies to monitor process critical control points. The PAT framework addresses every aspect from incoming raw materials to optimization to continuous improvement. It starts with processability of the incoming raw materials; their attributes would be used to adjust the process parameters. The incoming material attributes could be used to predict or adjust optimal processing parameters. The link between PAT and the new 21st Century Good Manufacturing Practices initiative, from the FDA's perspective, is "quality depends on knowledge and PAT brings



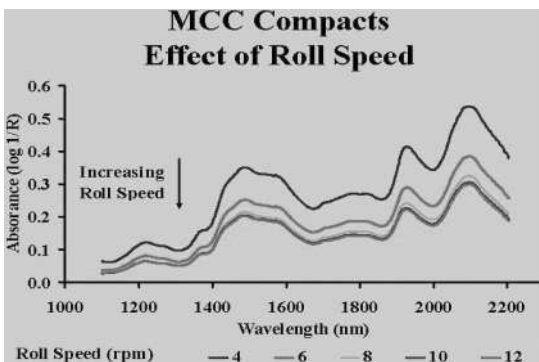
**Figure 21** 90/10 Aspirin/Starch granules NIR absorbance with compactor settings. (From Ref. 39.)



**Figure 22** NIR absorbance 90/10 Ibuprofen/Starch processing effects. (From Ref. 39.)

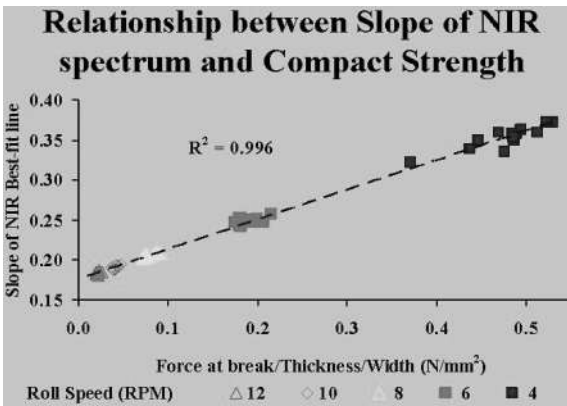
more knowledge and understanding of processes. This is the point where science and risk-based decisions can be made in terms of manufacturing per Dr. A. Hussain” (40).

In 2002–2003 Gupta, Morris, and Peck from Purdue University Industrial Physical Pharmacy School began a series of noninvasive real-time investigations. Evaluating roller compaction by NIR in the dynamic mode, the team monitored the variation of compacted ribbon strength that could adversely affect particle size and distribution of granules obtained after milling a compact (41). Their thinking was that both the ribbon strength and the particle-size distribution can be determined off-line but it is time consuming. The ability to use NIR spectra to quantify the compact strength, the particle size, and to estimate postmilling particle-size distribution could be done in real time. The most obvious NIR spectral change that occurs in compacts or tablets prepared under increasing pressure is an upward shift in the NIR spectral baseline (39). Kirsch and Drennen used the slope of the best-fit line through spectra to quantify this upward shift and found a linear correlation between this slope and the tablet hardness determined by the diametral compression test (42). Gupta et al. applied this treatment to correlate the slope of the best-fit line through the NIR spectra with the strength of compacts was determined using the three-point beam bending technique (41). Additionally, slope values were correlated



**Figure 23** MCC compacts: effect of roll speed. (From Ref. 41.)

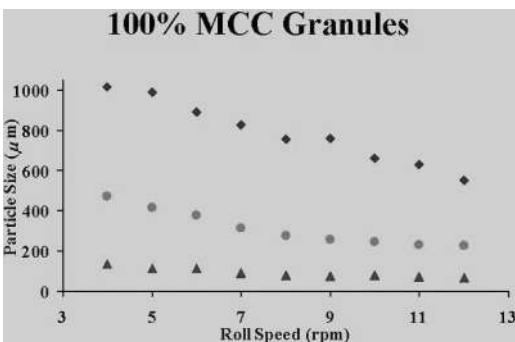




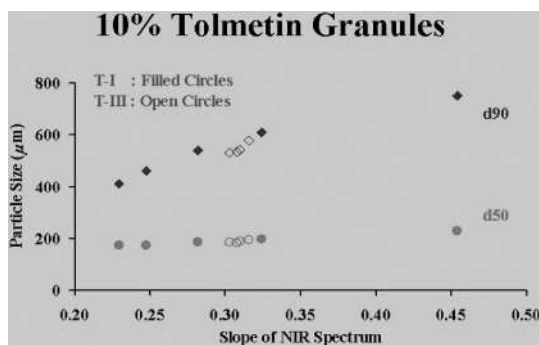
**Figure 24** Relationship between slope of NIR spectrum and compact strength. (From Ref. 41.)

to the particle-size distribution of granules produced from milled compacts. Real-time on-line techniques were used to monitor the roller compaction unit operation for microcrystalline cellulose and 10% active blend. The spectra collected on the different compact segments prepared from the same material under the same roller compactor settings showed little variation, suggesting good reproducibility in the data collection by the NIR sensor. A significant shift in the NIR spectra was observed for compacts prepared at different roll speeds.

At constant feed screw speeds, the spectra shifted toward lower absorbance values with increasing roll speed (Fig. 23). This shift was observed with compacts prepared from both the placebo and the 10% tolmetin blends. The shift in the NIR spectra may be quantified, using the slope of the spectral baseline or using the slope of the best-fit line, by regression analysis through the spectrum (41). Use of the slope of the best-fit line was advantageous over the slope of the baseline since the best-fit line uses information from the entire spectrum. The normalized force values for the compacts showed strong linear correlation with the slopes of the spectral best-fit lines (Fig. 24). It was observed that the particle-size distribution of the milled compacts exhibits a steady decrease in the  $d_{90}$ ,  $d_{50}$ , and  $d_{10}$  values with increasing roller-compactor roll speed at constant rate (Fig. 25).



**Figure 25** Relationship of milled 100% compacts at various roll speeds. (From Ref. 41.)



**Figure 26** Milled tolmetin 10% compacts. (From Ref. 41.)

The values for the particle-size distribution for the milled 10% tolmetin compacts correlated well with the slopes of the spectral best-fit line (Fig. 26). This clearly shows the potential of the technique in predicting the particle-size distribution of milled compacts under a given set of milling conditions. Multivariate analysis of the spectral data using PLS regression analysis confirmed the ability of the slope of the spectral best fit to estimate the compact strength and the postmilling particle-size distribution. For greater detail in this expanding new technology area the interested reader should examine the references.

## ACKNOWLEDGMENTS

The author gratefully acknowledges and thanks Carol G. Miller for her contributions and assistance in editing and data manuscript control. The author thanks and appreciates Dr. Pierre Guigon, Professor and Director of Chemistry at the University of Technology of Compiègne, France, for his collaborative contributions to the text. The author thanks and appreciates Mr. Abhay Gupta, Ph. D. former graduate student at the Industrial Physical Pharmacy School of Purdue University, West Lafayette, IN, USA. The author acknowledges and thanks Mr. Leonard Minervini, Alexanderwerk, Inc., Hatboro, PA, USA, for electronic files of photographs and pictures.

## REFERENCES

1. Kristensen HG, Schaefer T. Granulations. Swarbrick J, Boyland J, eds. *Encyclopedia of Pharmaceutical Technology*. Vol. 7. New York: Marcel Dekker, 1993:121–126.
2. Capes CE. Particle size enlargement. Williams J, Allen T, eds. *Handbook of Powder Technology*. Vol. 1. Amsterdam: Elsevier, 1980.
3. Capes CE. Particle size enlargement. Grayson M, Eckroth D, eds. *Kirk-Othmer Encyclopedia of Chemical Technology*. Vol. 21. 3rd ed. New York: Wiley, 1978:77–105.
4. Pietsch WB. Size enlargement by agglomeration. In: Fayed M, Otten L, eds. *Handbook of Powder Science and Technology*. New York: van Nostrand Reinhold Co, 1984:Chap. 7.
5. Pietsch WB. In: Roth D, ed. *Agglomeration Techniques for the Manufacturing of Granular Materials with Specific Product Characteristics*. The Institute for Briquetting and Agglomeration Proceedings. Vol. 25. Erie, PA: Gannon University, 1997:49–164.
6. Sherrington PJ, Oliver R. In: *Granulation*. London: Heyden & Son, 1981.

7. Kapur PC. *Adv Chem Eng* 1978; 10:55.
8. Kristensen HG, Schafer T. *Drug Dev Ind Pharm* 1987; 13:803.
9. Lindberg N. Industrial wet granulation. *Acta Pharm Suec* 1988; 25(special issue): 185–280.
10. Fonner DE, Anderson NR, Banker GS. Granulation and tablet characteristics. In: Lieberman HA, Lachman L, eds. *Pharmaceutical Dosage Forms. Tablets. Vol. 2*. New York: Marcel Dekker, Inc., 1982:Chap. 5.
11. Anderson NR, Banker GS, Peck GE. Principles of improved tablet production system design. In: Lieberman HA, Lachman L, eds. *Pharmaceutical Dosage Forms. Tablets. Vol. 3*. New York: Marcel Dekker, Inc., 1982:Chap.1.
12. Ghebre-Sellassie I. *Pharmaceutical Pelletization Technology*. New York: Marcel Dekker Inc, 1989.
13. Miller RW. *Roller Compaction Technology*. Parikh DM, ed. *Handbook of Pharmaceutical Granulation Technology. Vol. 81*. New York: Marcel Dekker Inc, 1997:99–150.
14. Pietsch WB. *Roll Pressing*. London: Heyden, 1976.
15. Parrot EL. *Pharmaceutical Dosage Forms. Vol. 2*. New York: Marcel Dekker Inc, 1990:203–204.
16. Dehont FR, Hervieu PM, Jerome E, Delacourte A, Guyot JC. Briquetting and granulation by compaction: a new granulator-compactor. Wells J, Rubinstein M, eds. *Pharmaceutical Technology, Tableting Technology. Vol. 2*. London: Ellis Horwood, 1993:1–11.
17. Heckel RW. Density-pressure relationships in powder compaction. *Trans Metall Soc AIME* 1961; 221:671–675.
18. Johanson JR. Rolling Theory for Granular Solids. *Trans Am Soc Mech Eng* 1965: 842–848.
19. Jenike AW, Shield RT. Plastic flow of Coulomb solids beyond original failure. *J Appl Mech* 1959; 26:599–602.
20. Parrott EL. Densification of powders by concavo-convex roller compactor. *J Pharm Sci* 1981; 70(30):288–291.
21. Miller RW. Advances in pharmaceutical roller compactor feed system designs. *Pharm. Technol* 1994:154–162.
22. Shileout G, Lammens RL, Kleinebudde P. Dry granulation with a roller compactor Part 1: the function units and operational modes. *Pharm Technol Eur* 2000:24–35.
23. Miller RW. *Roller Compaction Technology for the Pharmaceutical Industry*. *Encyclopedia of Pharmaceutical Technology*. New York: Marcel Dekker, Inc., 2003 (on-line).
24. Dehont FR, Hervieu PM. Briquetting and granulation by compaction new granulator compactor for the industry. *Drug Dev Ind Pharm* 1989; 15(14–16):2245–2263.
25. Pietsch W. Size enlargement by agglomeration. Fayed M, Otten L, eds. *Handbook of Powder Science, and Technology*. 2nd ed. New York: Chapman and Hall, 1997: 347–364.
26. Funakoshi Y, Asogawa T, Satake E. Use of a novel roller compactor with a concavo-convex roller pair to obtain uniform compacting pressure. *Drug Dev Ind Pharm* 1977; 3(6):555–573.
27. Parrott EL. Densification of powders by concavo-convex roller compactor. *J Pharm Sci* 1981; 70(3):288–289.
28. Jerome E. Measurement of resulting forces on a roller compactor. *Drug Dev Ind Pharm* 1991; 17(12):1571–1591.
29. Johanson JR. Predicting limiting roll speed for briquetting presses. *Proceedings of the 13th Institute for Briquetting and Agglomeration. Vol. 13*. 1975:89–99.
30. Sheskey PJ, Hendren J. The effects of roll compaction equipment variables, granulation technique, and HPMC polymer level on a controlled-release matrix model drug formulation. *Pharm Technol* 1999; 23(3):90–106.
31. Johanson JR. Roll press feed systems. *Proceedings of the 24th Institute for Briquetting and Agglomeration, October. Vol. 24*. 1995:149–163.

32. Weggel RW. The basics of force-feed roll briquetting. *Manuf Eng* 1982;107–109.
33. Miller RW, Sheskey PJ. Survey of current industrial practices and preferences of roller compaction technology and excipients year 2000. *Am Pharm Rev Spring* 2001; 4(1):24–35.
34. Guigon P, Simon O. Correlation between the geometry of feeding system and the stress distribution applied on the compact. In: Roth D, ed. *Proceedings of the 27th Institute for Briquetting and Agglomeration*, Providence, RI, Nov 2001. Vol. 27. Erie, PA: Gannon University, 2001:31–41.
35. Johanson JR, Cox BD. Fluid entrainment effects in roll press compaction. *Proceedings of the 20th Institute for Briquetting and Agglomeration*. Vol. 20. 1987:251–263.
36. Dec RT. Problems with processing of fine powders in roll press. *Proceedings of the 24th Institute for Briquetting and Agglomeration*. 1995; 24:199–210.
37. Miller RW. Using vacuum–deaeration feed system to minimize powder leakage during roll compaction. *Powder Bulk Eng* 1997; 11(2):71–75.
38. Miller RW. Vacuum deaeration advances in pharmaceutical roller compaction technology. *Proceedings of the 24th Institute for Briquetting and Agglomeration* 1995; Vol. 24:165–173.
39. Miller RW. Roller compaction optimization—NIR in-process mapping. *J Pharm Technol* 1999; yearbook supplement:30–39.
40. Miller RW. Process analytical technologies PAT part 2. *Am Pharm* 2003; 6(1):52–61.
41. Gupta A, Peck GE, Morris KR. Near infrared monitoring of roller compaction. In: Roth, ed. *Proceedings of the Institute of Briquetting and Agglomeration*. Vol. 28. Erie, PA: Gannon University, 2003:20–34.
42. Kirsch JD, Drennen JK. Nondestructive tablet hardness testing by near-infrared spectroscopy: a new and robust spectral best-fit algorithm. *J Pharm Biomed Anal* 1999; 19(3–4): 351–362.
43. Johanson JR. Reducing Air Entrainment Problems in Your Roll Press. *Powder and Bulk Engineering* 1989; 3(2):43–46.

# 7

## High-Shear Granulation

**Rajeev Gokhale\***

*Incyte Corporation, Wilmington, Delaware, U.S.A.*

**Yichun Sun and Atul J. Shukla**

*College of Pharmacy, University of Tennessee, Memphis, Tennessee, U.S.A.*

### 1. INTRODUCTION

Granulation is the process of agglomeration of a powder mixture, which results in the enlargement of the particles. This is often necessary for manufacturing of solid dosage forms such as tablets. The materials, which are compressed into tablets, must possess adequate flowability, density, and compressibility. This is because the requisite amount of powder mixture required to compress each tablet is filled into the die cavity by volume and not by weight. This requirement of adequate flowability, density, and compressibility is particularly important during a high-speed tablet production where the dwell time is often short. For example, active pharmaceutical ingredients such as ibuprofen and acetaminophen, which have inadequate flow and compression properties, and a relative high dose, are often granulated prior to compression into tablets. Thus, the overall purpose of granulation is to improve the flowability and compressibility of the powder mixture. Besides improving the flowability and compressibility, the granulation process can also

- Densify the powder mixture and reduce dust
- Narrow the particle size distribution of the powder mixture
- Ensure uniform distribution of the drug in the powder mixture
- Improve the dissolution characteristics of the finished tablets.

The three commonly used granulation methods include wet granulation, dry granulation, and hot-melt granulation. These methods are categorized based on the type of binder and the process employed during granulation. The equipment that is used during the granulation processes is classified into the following three major categories, based on the shearing strength it generates on the powder bed:

1. Low-shear granulators—twin shell (Peterson Kelly, PK) with an agitator bar, dough mixer or planetary mixer, ribbon blenders, and fluid bed granulator without the roto granulator

---

\* *Present Address:* Merck Research Laboratories, West Point, Pennsylvania, U.S.A.

2. Medium-shear granulators—fluid bed granulators with a rotogranulator attachment
3. High-shear granulators.

The granulation techniques can affect the physical properties of the resulting granules, which then subsequently affect the tableting process, the quality, and the performance of the finished tablets, as illustrated in the following examples.

An extended release of matrix tablet formulation for metoprolol tartrate (100 mg) was prepared with three different granulation processes: direct compression, fluid-bed, or high-shear granulation (1). Different grades of hydroxypropylmethylcellulose (HPMC) (Methocel K4M, K15M, K100M, and K100LV) were used as fillers and binders. Direct compression formulations exhibited poor flow, picking and sticking problems during tableting. High-shear granulation produced hard granules, which were difficult to mill. However, they yielded good tablets. Granules produced by the fluid-bed granulation process appeared to have satisfactory flow and tableting performance.

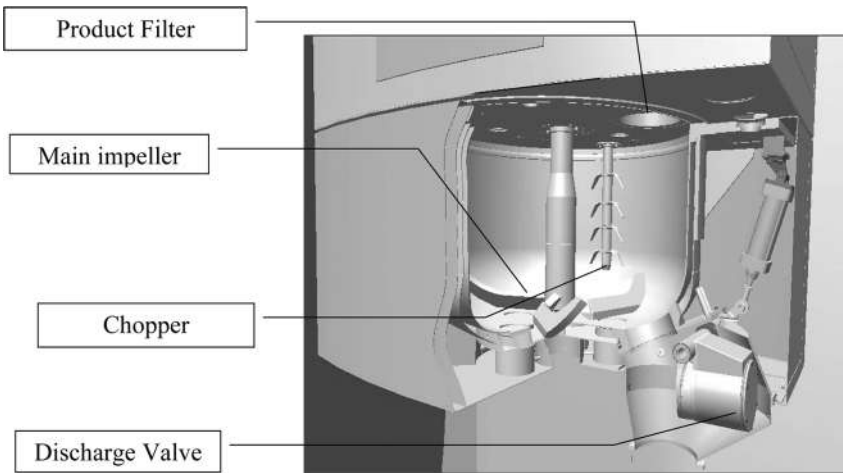
A hydrophilic matrix tablet formulation containing 60–70% drug, and low- or medium-viscosity grades of HPMC for extended oral delivery of zileuton, was prepared using the wet-granulation techniques (2). The granules were prepared with planetary (low shear) and high-shear granulators. In vitro drug release was evaluated using USP apparatus 1. Slower drug release was achieved from the granules prepared with the high-shear granulation process, because of the slower water penetration into the denser and less porous granules.

A high-shear mixer was utilized for the evaluation of pregelatinized, cross-linked, waxy corn starches as binding agents in the wet-granulation process (3). Lactose granules prepared in a high-shear mixer showed a larger average size than granules prepared in a low-shear mixer (planetary mixer), using the same amount of binding solution. The granules produced with high-shear mixer had lower friability than those prepared with the planetary mixer.

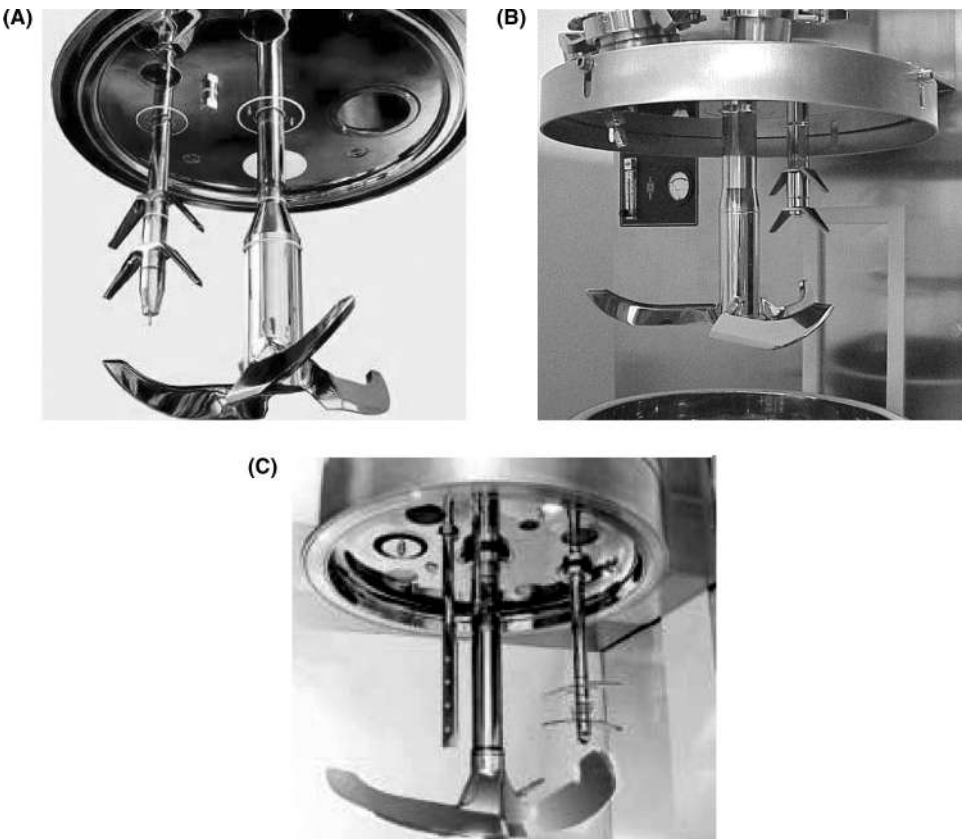
High-shear granulation has been one of the most commonly used methods to produce granules since the early 1980s (4). Hence, this chapter discusses in detail, the equipment, process variables, formulation requirements, granulation end-point determination, and scale-up considerations of the high-shear granulation process.

## 2. HIGH-SHEAR GRANULATORS

Most of the high-shear granulators consist of a mixing bowl, a three-bladed impeller, and an auxiliary chopper. The shape of the mixing bowl could be cylindrical or conical. The mixing bowl can be jacketed for heating or cooling the contents in the bowl, by circulating hot or cool liquid or steam through the jacket. An impeller is employed to mix the dry powder and spread the granulating fluid. The impeller of the high-shear mixer granulator normally rotates at a speed ranging from 100 to 500 rpm. The function of the chopper is to break down the wet mass to produce granules. The rotation speed of the chopper ranges from 1000 to 3000 rpm. The high-shear granulator could be termed as either vertical or horizontal, based on the orientation and the position of the impeller. The vertical high shear granulator could be either a top-driven or a bottom-driven unit. [Figure 1](#) shows the schematic view of a top-driven vertical high-shear granulator, ULTIMAGRAL™/ULTIMA-PRO™. [Figure 2\(a–c\)](#) shows photographs of choppers and impellers of top-driven vertical high-shear granulators: ULTIMA™, GMX™, and GMA™. [Figure 3\(a–d\)](#) shows photographs of top-driven, vertical, high-shear granulators: UltimaGral 150,



**Figure 1** Schematic view of top-driven vertical high shear granulator. (ULTIMAGRAL™/ULTIMAPRO™ courtesy of Niro Pharma Systems.)



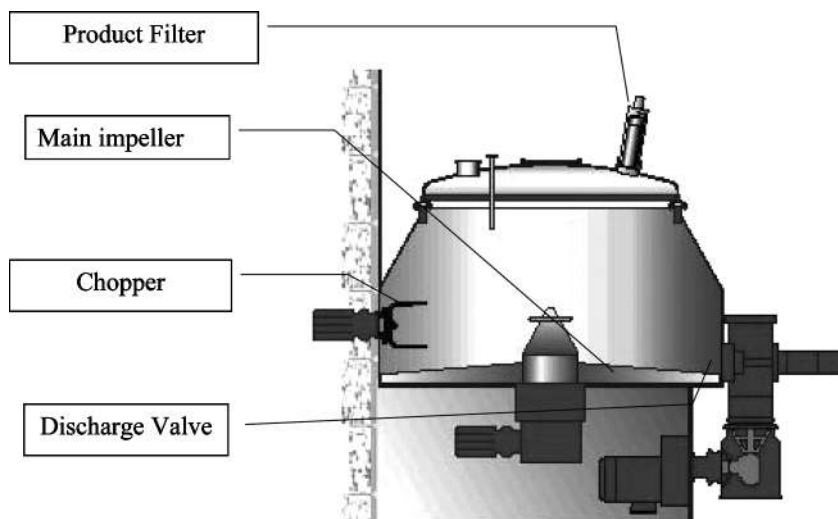
**Figure 2** (A) Photograph of an ULTIMA™ top-driven impeller and chopper. (Courtesy of Niro Pharma Systems.) (B) Photograph of a GMX™ top-driven impeller and chopper (Courtesy of Vector Corporation.) (C) Photograph of GMA™ top-driven impeller and chopper (Courtesy of L. B. Bohle.)



**Figure 3** (A) Photograph of a top-driven vertical high shear granulator (UltimaGral 150). (Courtesy of Niro Pharma Systems.) (B) Photograph of a top-driven vertical high shear granulator. (GMX 10 courtesy of Vector Corporation.) (C) Photograph of a top-driven vertical high shear granulator. (GMA 1200 courtesy of L. B. Böhle.) (D) Photograph of a top-driven vertical high shear granulator. (Courtesy of Glatt Air Techniques.)

GMX 10, GMA 1200, and Glatt. [Figure 4](#) shows the schematic view of a bottom-driven vertical high-shear granulator, with a horizontal chopper shaft (PMA through-the-wall design). [Figure 5\(A\)](#) and [5\(B\)](#) shows photographs of top views of bottom-driven impellers with horizontal choppers (Diosna and Glatt). [Figure 6\(A–C\)](#) shows the photographs of bottom-driven vertical high-shear granulators: Pharma Matrix™ PMA600 Podium, Diosna P 150, and Glatt. [Figure 7](#) shows the schematic view of a horizontal high-shear granulator (Loedige). [Figure 8](#) shows a photograph of a plow-shaped mixing blade and a chopper inside a horizontal





**Figure 4** Schematic view of a bottom-driven vertical high shear granulator with horizontal chopper shaft. (PMA through-the-wall courtesy of Niro Pharma Systems.)

high-shear mixer granulator (Loedige). [Figure 9](#) shows a photograph of a horizontal high-shear mixer granulator (FKM-1200–Loedige).

The size of the high-shear granulators varies considerably from the small laboratory-scale models to large production-scale models, depending on the type of the model and end use. High-shear granulators are often equipped with granulation end-point control devices, which are used to detect the end point of the granulation process. Some of the recently introduced features in high-shear mixer granulators are clean in place (CIP) or wash in place (WIP), and one-pot processing. High-shear granulators with CIP or WIP features can be cleaned easily, without removing the bowl, the impeller, and the chopper. The advantage of the one-pot processing system is that the wet granules can be dried in the same bowl without additional equipment for drying. Some of the suppliers of the commercially available high-shear granulators are listed in [Table 1](#).

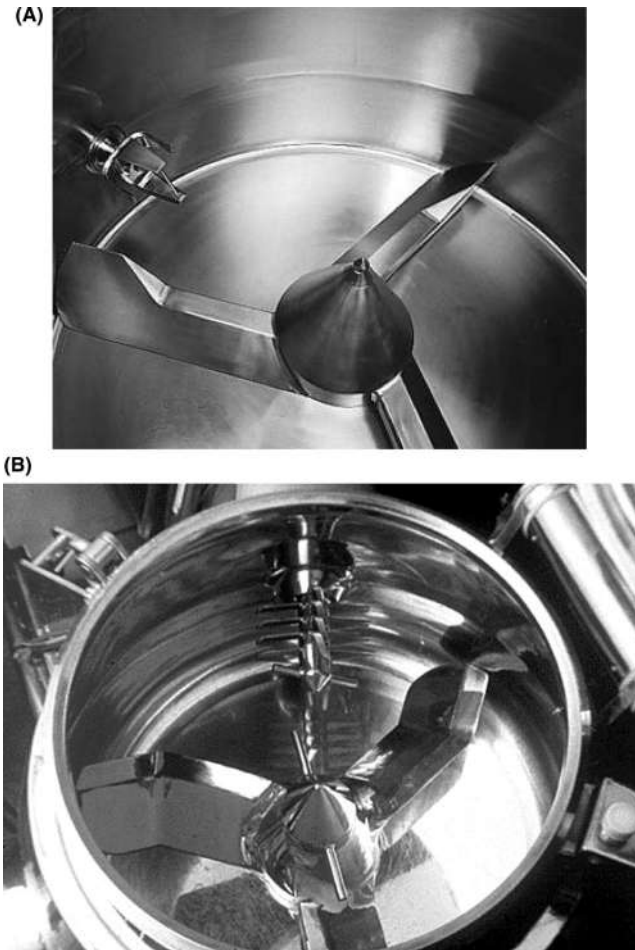
### 3. HIGH-SHEAR GRANULATION PROCESS

#### 3.1. Wet Granulation

The composition of a powder mixture for granulation generally consists of an active pharmaceutical ingredient (API), a filler, a disintegrant (usually not included in controlled release tablets), and a binder.

A high-shear wet-granulation process includes the following steps:

1. Loading all the ingredients into the mixing bowl, which can be accomplished by either of the following methods: gravity feeding with manual or pneumatic valve, and vacuum feeding.
2. Mixing of dry ingredients such as API, filler, and disintegrant, at high impeller and chopper speeds for a short period of time (2–5 min).
3. Addition of a liquid binder (either binder solution or solvent) into the powder mixture, while both the impeller and the chopper are running at a low speed.

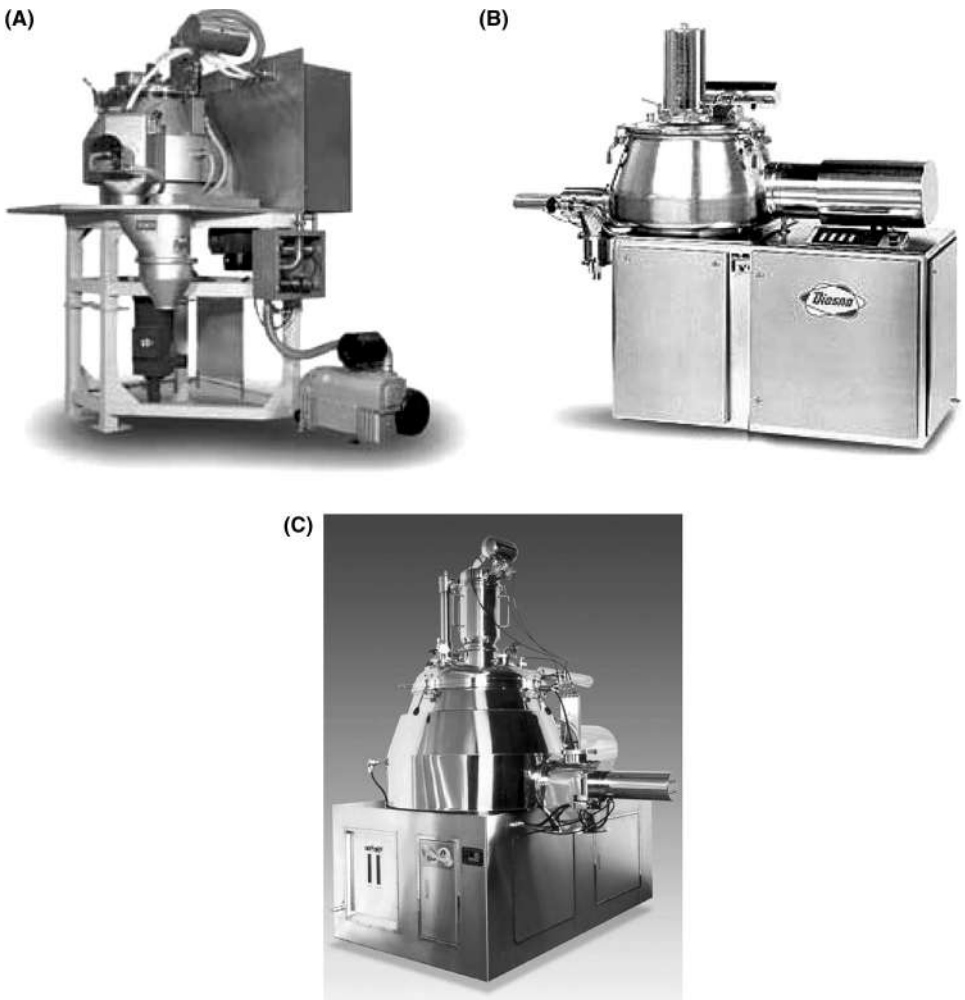


**Figure 5** (A) The top view of a bottom-driven impeller with a horizontal chopper. (Courtesy of Diosna.) (B) The top view of a bottom-driven impeller with a horizontal chopper inside a conical shaped mixing bowl. (Courtesy of Glatt Air Techniques.)

4. Wet massing with both the impeller and the chopper running at a high speed.
5. Removal of the resulting wet granules from the granulator bowl, and drying them using an appropriate drying technique such as fluid-bed or tray drying.
6. Sieving the dried granules.

The high-shear wet-granulation process offers several advantages over the other granulation processes. These include:

- Short processing time
- Use of less binder solution
- Granulation of highly cohesive materials containing hydrophilic polymers, which is not achievable with low-shear granulation processes
- Greater densification and production of less friable granules
- Production of reproducible granules with a uniform particle size distribution



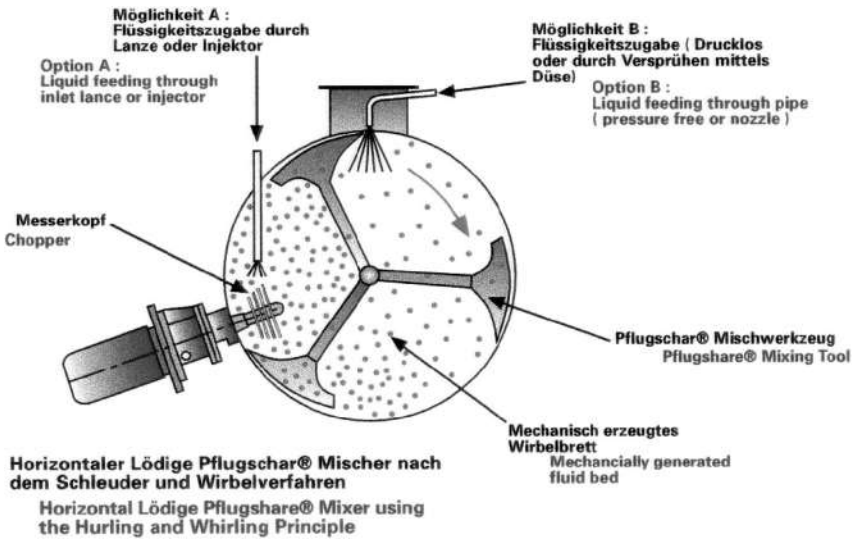
**Figure 6** (A) Photograph of a bottom driven Pharma Matrix™ PMA600 Podium/Through-The-Wall. (Courtesy of Niro Pharma Systems.) (B) Photograph of a bottom driven Mixer-Granulator. (P 150 courtesy of Diosna Dierks & Soehne GmbH.) (C) Photograph of a bottom driven high shear granulator. (Courtesy of Glatt Air Techniques.)

- Reduction of process dust, thus minimizing exposure to workers
- Obtaining predictable granulation end-point determination.

Despite the above advantages, the process is not immune to challenges such as:

- Production of less compressible granules, compared to low-shear granulation processes
- Narrow range of operating conditions

A commonly employed high-shear granulation process requires multiple unit operations, such as drying and sieving after wet granulation. The preferred drying method is fluid-bed drying, because of the distinct advantages over tray drying. However, a primary problem inherent in the two-step process of high-shear mixer granulation and fluid-bed drying is the possibility of exposure of the workers and



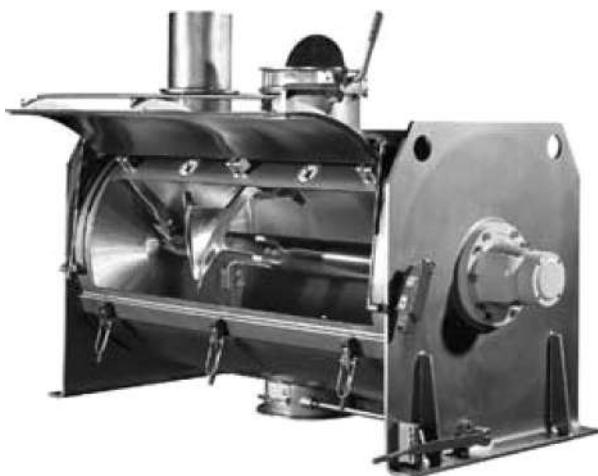
**Figure 7** Schematic view of a horizontal high shear mixer granulator. (Courtesy of Loedige.)

the environment to potentially toxic materials during the transfer of the wet granules from the high-shear granulator to the fluid bed. In order to remedy the contamination problem, the processing suites need to be operated under a negative pressure using powerful air filtration systems. Moreover, dehumidifying and heating of a large volume of air is also necessary during the fluid-bed drying process. Regulating the airflow and filtering the exhaust air during the drying process could also be challenging.

However, the above problems can be remedied by a one-pot approach in which the high-shear wet-granulation and drying processes are combined into a single step. This approach saves time, since cleaning and validating a single bowl is inherently easier than tackling two or three units. For example, a Mi-Mi-Pro high-shear granulator, combined with microwave, was employed to study the effect of process variables on the properties of the granules obtained, for the mixture of alpha-lactose monohydrate and microcrystalline cellulose (MCC) (5). The one-pot high-shear granulators are commercially available from several manufacturers. Options such



**Figure 8** Photograph of a plough-shaped mixing blade and a chopper inside a horizontal high shear mixer granulator. (Courtesy of Loedige.)



**Figure 9** Photograph of a horizontal high shear mixer granulator. (FKM-1200 courtesy of Loedige).

as oscillating the bowl during drying, vacuum drying, gas-assisted vacuum drying, and microwave drying are also available. [Figure 10](#) shows the schematic view of a single-pot processor ULTIMAPRO™, based on the ULTIMAGRAL™ with a vacuum drying system. [Figure 11](#) shows the photo of UltimaPro 600 single-pot processor at a swinging position (Niro Inc., Pharma Systems Division).

Another approach is to modify the wet-granulation process. This process is called moisture-activated dry-granulation process. The moisture-activated dry-granulation process consists of two steps, wet agglomeration of the powder mixture followed by moisture absorption stages. A small amount of water ( $\approx 1\text{--}4\%$ ) is added first to agglomerate the mixture of the API, a binder, and excipients. Moisture absorbing material such as MCC and potato starch is then added to absorb any excessive moisture. After mixing with a lubricant, the resulting mixture can then be compressed directly into tablets. Hence, this process offers the advantages of wet granulation, but eliminates the need for a drying step.

The applicability of a 25 L high-shear mixer for moisture-activated dry granulation of phenobarbital was investigated by Christensen et al. (6). MCC, potato starch, or a mixture of 50% of each was used as moisture absorbing material. The results of the study showed that the physical properties of the tablets were primarily affected by the water content, the moisture absorbing material, and the compression force.

### 3.2. Hot-Melt Granulation

Hot-melt granulation in a high-shear granulator is a versatile approach. Hot-melt granulation utilizes a binder, which is a solid or semisolid at room temperature and melts at a temperature below the melting point of API. Generally, the melting point of such binders is between  $30^{\circ}\text{C}$  and  $100^{\circ}\text{C}$ . The binder, when heated near its melting point, liquifies or becomes tacky. This tacky and liquified form of binder agglomerates the powder mixture, which upon cooling forms a solid granulated mass. The energy to melt the binder may be derived from heat dissipated from the circulating hot liquid, such as steam, water, or oil through jacketed bowl, or heat generated by the friction of high-shear mixing. A solvent such as water or an organic

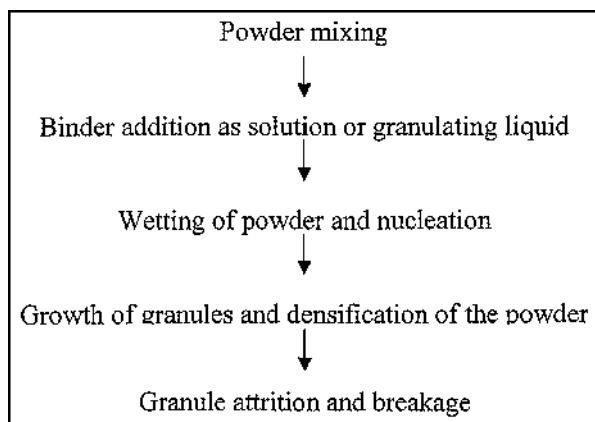
compound is not necessary to initiate particle binding in this method. The resultant granules are compressed into tablets.

A series of studies have been carried out by Schaefer and his colleagues to investigate the effects of formulation and process variables on the hot-melt granulation process, and the properties of the obtained granules (7–13).

In spite of numerous granulation options available to a formulator, high-shear wet granulation remains the method of choice.

#### 4. MECHANISM OF HIGH SHEAR WET GRANULATION

The high-shear wet-granulation process can be divided into five stages as shown below, namely, mixing, adding binder solution, wetting and nucleation, consolidation and growth, and granule attrition and breakage.



The binder solution or the granulating liquid is distributed through the powder bed by mechanical agitation created by the impellers. At this stage, the powder mixture becomes wetted and initiates agglomeration via nucleation. Nucleation of particles occurs by the formation of liquid bridges between primary particles, which adhere together to form agglomerates. At this stage, the concentration of liquid phase in the powder mixture is relatively low, but high enough to establish liquid bridges. The addition and distribution of binder solution can have a major impact on the particle size distribution and quality of the granules. Poor liquid distribution produces granules with a wide particle size distribution. These granules could include large, overwetted particles, as well as small dry particles.

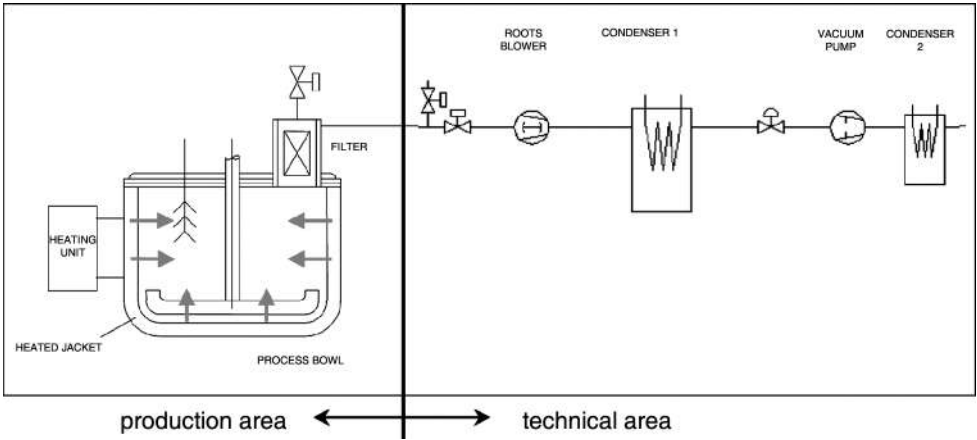
Granule growth is dominated by one of the two mechanisms: coalescence or layering (14). Coalescence is agglomeration which occurs by collision and consolidation of deformable nuclei/granules, provided the agglomerates could withstand the shear forces applied by the impellers. Layering occurs when fine particles stick to larger particles or granules coated with binder. Free liquid on the surface of agglomerates, which renders the necessary bonding strength and plasticity to the agglomerate, is required for coalescence or layering. The free liquid on the surface of the agglomerates can be from the addition of more binder solution or from

**Table 1** List of High-Shear Granulator Suppliers

Supplier	Granulator	Contact information
DIOSNA Dierks & Soehne GmbH	Diosna P high-shear granulators	270 Route 46 Rockaway, NJ 07866, Tel: (973) 586-3708, Fax: (973) 586-3731, e-mail: marc_kaufman@servo-lift.com
Glatt Air Techniques	VG high-shear granulators	20 Spear Rd, Ramsey, NJ 07446, Tel: (201) 825-8700, Fax: (201) 825-0389, e-mail: info@glattair.com
Key International, Inc.	KG-5 high-shear granulators	480 Route 9, Englishtown, NJ 07726, Tel: (732) 536-9700, Fax: (732) 972-2630, e-mail: info@keyinternational.com
L.B. Bohle Inc.	GMA, VMA, and BMG high-shear granulators	L.B. Bohle, LLC, 700 Veterans Circle, Suite 100, Warminster, PA 18974, Tel: (215) 957-1240, Fax: (215) 957-1237, e-mail: info@lbbohle.com
Littleford Lodge	KFM and MGT high-shear granulators	Lodge Process Technology, Inc., 203 Forrester Creek Way, Greenville, SC 29607, Tel: (864) 254-9194, www.loedige.de
Niro Inc. Pharma Systems Division	ULTIMAGRAL <sup>TM</sup> , ULTIMAPRO <sup>TM</sup> , and PMA high-shear granulators	9165 Rumsey Road, Columbia, MD 21045, Tel: (410) 997-7010, Fax: (410) 997-5021, e-mail: info@niroinc.com
Vector Corporation	GMX high-shear granulators	Vector Corporation, 675 44th St. Marion, IA 52302-3800, Tel: (319) 377-8263, Fax: (319) 377-5574, www.vectorcorporation.com
Zanchetta (A division of Romaco)	ROTO high-shear granulators	Romaco USA, 242 West Parkway, Pompton Plains, NJ 07444, Tel: (973) 616-0440, Fax: (973) 616-9985, e-mail: usa@romaco.com

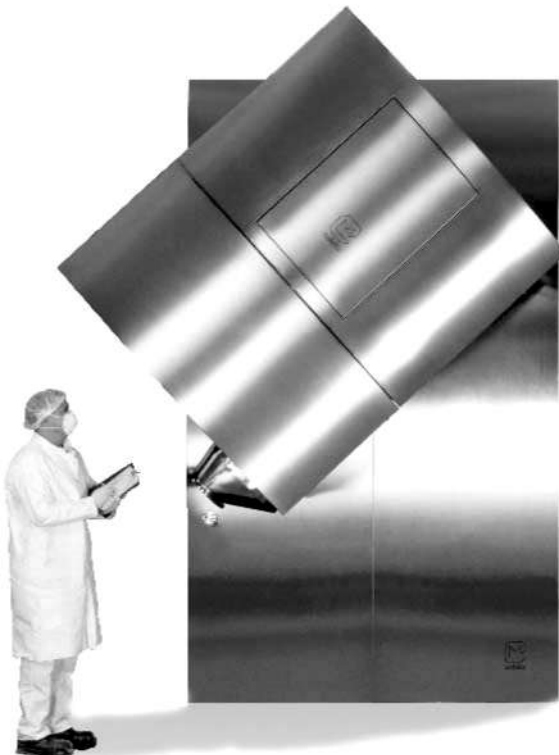
the expulsion of liquid inside the agglomerates due to the consolidation of the agglomerates.

Granule attrition and breakage reduce the granule size. Granule breakage is determined by the dynamic granule strength and the shear forces within the



**Figure 10** Schematic view of a single-pot processor ULTIMAPRO™ based on the ULTIMAGRAL™ with a vacuum drying system. (Courtesy of Niro Pharma Systems.)

granulator. If the impact forces are larger than the granule strength, continuous breakage and immediate coalescence of the granules takes place (15). However, when the granule strength exceeds the impact forces, granules will not break. In that case, granule growth is more static, i.e., the exchange of primary particles between the



**Figure 11** Photograph of an UltimaPro 600 single pot processor (granulator is in a swinging position with an operator). (Courtesy of Niro Pharma Systems.)



granules is minimal. Thus, there is a balance between agglomerate growth and degradation of the granules.

The liquid level in the powder bed in a high-shear granulator plays a key role in the growth of granules. Granule growth and consolidation (densification) occur at the same time in the high-shear granulation process. Since deposition of free liquid on the surface of agglomerates is required for coalescence or layering to occur, maintenance of the free liquid on the surface of the agglomerates is critical for the growth of granules in a high-shear wet-granulation process (16). The agglomeration of fine particles is controlled mainly by the liquid saturation of the moist agglomerates, which is the percentage of intragranular voids filled with the liquid. Increasing the amount of granulating liquid reduces the yield stress necessary to deform the agglomerates in collision, thus allowing growth by coalescence with other granules. This deformation also makes it possible to consolidate the granules, which further increases the liquid saturation level and squeezes additional fluid to the granule surface for continued growth.

The moist agglomerates can exist in the following three states, based on the amount of the liquid they contain: the pendular state, the funicular state, and the capillary state. The three states can be distinguished by the relative liquid saturation of the pores  $S$ , which is the ratio of pore volume occupied by the liquid to the total volume of the pores available in the agglomerate.

Agglomerates are in the pendular state when the liquid saturation of the pores  $S < 25\%$ ; in the funicular state when  $S$  is between 25% and 80%; and in the capillary state when  $S > 80\%$ . The liquid saturation  $S$  is determined by the amount of binder solution and the intragranular porosity, which can be calculated based on the following equation (17):

$$S = \frac{H(1 - \varepsilon)}{\varepsilon} \rho \quad (4.1)$$

where  $H$  is the ratio of the mass of liquid binder to the mass of solid particles,  $\varepsilon$  is the intragranular porosity, and  $\rho$  is the particle density.

Therefore, the formulation, process, and granulator factors that affect the degree of liquid saturation would play a critical role in defining the robustness of the granulation process and the properties of the granules obtained. The effects of the starting material properties, the type of granulator, and its operation on the granule growth can be evaluated by assessing the changes in the intragranular porosity, which occur during the process, since intragranular porosity affects the degree of liquid saturation as indicated by Eq. (4.1). The properties of the granules, such as particle size distribution, porosity, and content uniformity would affect the properties and performance of the dosage forms prepared from these granules.

#### 4.1. Liquid Requirement

The optimal amount of liquid binder used for high-shear granulation is within a narrow range. If the optimal amount of binder solution is not used, there could be neither growth nor lump formation during the wet-granulation process. In theory, the amount of liquid used during the wet-granulation process should be equal to or just exceed the liquid content corresponding to 100% liquid saturation. However, some grades of lactose and dicalcium phosphate (DCP) could be granulated by coalescence at liquid saturation far below 100% (18). It would be desirable to predict the

required amount of liquid binder based on the formulation composition. However, this is a challenging task, since the liquid binder required for high-shear granulation depends on a number of formulation and process factors, such as physicochemical properties of the starting materials (API and excipients), type of the binder used, impeller speed, wet-massing time, etc.

## 5. FACTORS AFFECTING THE GRANULATION PROCESS AND GRANULE PROPERTIES

Performance and physical properties of the compressed tablets are driven by properties of the granules. Yajima et al. (19) examined the relationship between particle size distribution and physical properties of the obtained granules (e.g., angle of repose, angle of spatula, loose bulk density, tapped bulk density, compressibility) and the resulting tablets (hardness and weight variation of tablets). The particle size distribution of the granules used for tablet compression was expressed as a function of median particle size, and standard deviation with a logarithmic normal distribution. Physical properties of granules and the compressed tablets were significantly affected by this factor. Tablet hardness increased as the median particle size decreased, when the standard deviation was  $<1.0$ .

In another example, Wikberg et al. (20) produced 11 granulations of a common filler (lactose) and three granulations of a high-dose drug (dipentum) by wet granulation with polyvinylpyrrolidone (PVP) as binder, in a high-shear mixer granulator. The agglomeration process was varied to produce granules with varying granule porosity. The granule fragmentation during compression was evaluated by measurements of air permeability of the tablets. The results showed that the degree of granule fragmentation during compression was related to the granule porosity before compaction. A granulation with a higher porosity had a higher fragmentation propensity during compression. The tablet strength correlated well with the degree of fragmentation, i.e., a granulation with a higher degree of fragmentation yielded tablets of a higher hardness. Variations in compactibility can be explained by variations in granule porosity for the same formulation that was wet granulated under different process conditions. Therefore, the formulation variables and granulation process should be controlled to produce granules with the desired properties. Since granule formation in high-shear wet granulation is dependent on the degree of liquid saturation, the factors that influence the degree of liquid saturation should be optimized to obtain an optimal granulation formulation. The factors that affect the degree of liquid saturation (which depends on the amount of liquid added as well as on the densification of the granules) are formulation, process, and apparatus variables. Hence, the granulation process and the properties of the granules are affected by the aforementioned variables.

### 5.1. Formulation Variables

Besides the API, excipients such as a filler or fillers, a disintegrant (not applicable to controlled release), and a binder are also included in the powder mixture of a tablet formulation. The fillers used in tablet formulations can be classified into two categories, based on their water solubility: soluble fillers such as lactose, sucrose, mannitol, etc., and insoluble fillers such as MCC, starch, calcium carbonate, calcium phosphate, etc. The binders used in the wet granulation process are water-soluble

polymers such as gelatin, PVP, HPMC and sugars such as glucose, sucrose, and sorbitol. Some of the commonly used disintegrants are sodium starch glycolate, cross-linked PVP, and cross-linked sodium carboxymethylcellulose. These excipients are available in various grades from vendors. Hence, the physical properties such as particle size distribution, particle shape, surface morphology, surface area, and solubility of API and excipients in the binder solution could vary considerably. The rate and the final degree of densification are controlled by the physical properties such as particle size distribution, particle shape, surface morphology, surface area, solubility in the binder solution, etc., of the starting materials. Therefore, the physical characteristics of drug and drug loading, the types and amount of excipients, and the type and amount of binder used could affect the rate and the final degree of densification of the resulting granules. Moreover, these aspects of the powder mixture can also affect the amount of liquid required for granulation and the degree of liquid saturation in the agglomerates, during the wet-granulation process, which in turn affect the physical properties of the obtained granules.

## 5.2. Effects of Starting Materials

The physical properties of the granules are influenced by the physical properties of the starting materials. For example, the shape, size, and size distribution of the particles of the starting materials can affect the packing pattern of a powder mixture, and ultimately the final degree of densification and the strength of the resulting granules. The extent of granule densification affects the degree of liquid saturation of the powder mixture, and the amount of liquid binder required for granulation. The total surface area of the starting materials, related to the particle size and porosity of the starting materials, will affect the amount of liquid binder required for granulation. The liquid adsorption of the starting material could also affect the amount of liquid binder required for wet granulation. Therefore, the amount of binder solution required for granulation depends on the formulation composition, and the physical characteristics of the starting materials. In a study by Schaefer et al. (21), when the mean particle size of lactose was decreased, the amount of liquid required for granulation was increased to obtain a similar particle size of granules in high-shear granulation.

The influence of the primary particle size of DCP on granule growth in a Lödige M5GR high-shear mixer granulator was investigated by Schaefer et al. (22). Two batches of DCP, one with a narrower particle distribution and smaller geometric mean diameter, and the other with a wider particle size distribution and a larger geometric mean diameter were used. The batch with the narrower particle size distribution and smaller geometric mean diameter was more easily densified than the one with the wider particle size distribution and a larger geometric mean diameter, because it was overwetted at lower moisture content. The granules with wider particle size distribution were produced from the DCP with a wider particle size distribution and larger geometric mean diameter.

The strength of wet agglomerates can be dominantly affected by the degree of liquid saturation and the primary particle size of the starting materials. Consequently, the growth mechanism and drug content uniformity of the resulting granules can be affected.

The influence of the primary particle size of lactose on the breakage of erythro-sine granules was investigated by van den Dries et al. (4). The results showed that a decrease in particle size of the starting material, lactose, led to a decrease in

breakage of granules. When granule breakage was absent, the granules remained intact and the preferential layering of the smallest particles yielded inhomogenous granules.

The effect of particle size of the lactose on the homogeneity of low-dose steroid hormone distribution in granules produced in high-speed mixers was studied by Vromans et al. (23). When a micronized low-dose steroid hormone was granulated with unmiconized lactose at 250 rpm, inhomogeneity of active was observed. The coarse particle size fractions of the granules were found to be superpotent, up to 150% of the mean drug content, whereas the fine size fraction showed a corresponding subpotency of 50%. However, when the particle size of lactose was reduced, a better drug distribution was seen. This was attributed to an increase in the tensile strength of the nuclei due to the smaller particle size of lactose.

The effect of particle size of lactose on the homogeneity of estradiol granules prepared in a 10 L high-shear mixer was studied by van den Dries et al. (15). Three different particle sizes of lactose were granulated with 0.1% micronized estradiol (5  $\mu\text{m}$ ) using an aqueous solution of hydroxypropyl cellulose (HPC) as a binder. Granules prepared with the largest lactose particles (141  $\mu\text{m}$ ) yielded a homogenous granulate. However, after a prolonged processing time, demixing was observed. Contrary to the largest particles, granulation with the smaller lactose particles (23 and 50  $\mu\text{m}$ ) led to demixing in the first minute, although to a lesser extent. It was concluded that granulation with the largest particles resulted in breakage of the granules, thereby preventing demixing. However, once the granules were strong enough (smaller particle size and prolonged process time) to survive the shear forces, demixing was observed. The extent of demixing depended on the particle size difference.

The size distribution of granules prepared from three different tablet excipients, lactose, glucose, and mannitol, in a high-shear granulator, were studied by both sieve analysis and laser light diffractometry (24). Both the shapes and the size distribution of the granules produced from the three excipients differed.

The crystallinity of the starting materials affected the granulation process and the properties of the granules. The effect of crystallinity of MCC on wet granulation, in binary mixtures of MCC and corn starch (CS), was investigated by Suzuki et al. (25). The crystallinity of MCC was modified, producing amorphous material by milling in a jet mill (J-MCC) and a vibrational rod mill (R-MCC). Crystallinity of J-MCC was nearly equal to that of intact MCC (I-MCC), but that of R-MCC was remarkably low due to the mechano-chemical effect. The growth rate of granules with R-MCC was greater than that with I-MCC and J-MCC. The formulations containing I-MCC and J-MCC produced granules with a core (MCC and CS) around which CS was layered. R-MCC provided granules in which CS and abraded MCC were homogeneously mixed. In addition, R-MCC remarkably decreased the difference in drug content among the size fractions of granules compared with I-MCC. The decrease in crystallinity of MCC increased the abrasion of the material by the impeller. This resulted in a greater growth rate of granulation.

The physical properties of the API also affect the wet granulation process and the properties of the resulting granules. For example, when the particle shape of the API was changed from spherical to plate like due to a change in the crystallization solvent, the compressibility of the resulting granules dramatically decreased (26).

The effect of the particle size of DPC 963 (API) on the characteristics of granules prepared by high-shear wet granulation was evaluated by Badawy et al. (27). Particle agglomeration was affected by the particle size of the drug substance. Granule geometric mean diameter and fraction with particle size greater than

250  $\mu\text{m}$  was inversely proportional to the particle size of the drug substance. The granules prepared with the smaller particle size had higher porosity, thus suggesting lower tendency for granule densification than those manufactured with the larger particle size. The compressibility of the granules was increased with decreasing particle size of the drug substance. The effect of particle size on granulation growth is the result of increased densification propensity from increased drug particle size.

In another study, a high-shear mixer granulator was used for pelletizing a drug. High-dose pseudoephedrine-HCl pellets were produced with MCC in a high-shear mixer granulator (28). The drug loading and drug particle size influenced the bulk and true densities of the resulting pellets.

### 5.3. Effects of Type and Amount of Binder Solution Used

A binder is normally required for the wet-granulation process. The binder can be added into the powder mixture as a dry powder followed by the addition of water, or an appropriate solvent to activate binding. Alternatively, the binder can also be added into the powder mixture as a binder solution. Because of the higher densification of the wet agglomerates, the high-shear granulation process normally only needs two-thirds to three-quarters of the liquid required during the low-shear granulation process (18). The bonding characteristics of the binders used for wet granulation could vary due to the differences in their physicochemical properties. Therefore, the type of binder used for granulation can influence the granulation process, the amount of binder required for granulation, and the physical properties of the obtained granules.

For example, the effect of binder solutions on the size of DCP granules was investigated by Ritala et al. (29). Five different binders, PVP (Kollidone 90), polyvinylpyrrolidone–polyvinylactate copolymer (PVP–PVA copolymer), hydrolyzed gelatin and HPMC (Methocel E5 and Methocel E15) were studied. The granules prepared with PVP and hydrolyzed gelatin possessed a larger mean particle size and lower intragranular porosity when the same volume of binder solutions was used. The other three binder solutions behaved similarly. This could be due to the higher densification of DCP granule caused by PVP and hydrolyzed gelatin. Thus, the granules had higher liquid saturation with lower volumes of the binder solutions. It was apparent that increasing the concentration of the binder solution in the powder mixture increased the mean granule size.

In another study, Ritala et al. (30) investigated the differences between five binders during wet granulation using a high-shear granulator. The binders used for the study were PVP K90, PVP K25, PVP–PVA copolymer, Methocel E5, and Methocel E15. The results demonstrated that the binder solutions with high surface tension, such as PVP solutions, produced denser granules with larger mean particle size than those with low surface tension, such as PVP–PVA copolymer, Methocel E5, and Methocel E15. The difference of granule growth by different binders in high-shear wet granulation could be due to the variation of surface tension of the binder solutions.

The amount of binder and granulating liquid used during granulation affect the granulation process and the physical characteristics of the prepared granules. In general, the granules are finer when the amount of granulating liquid used for granulation is decreased. For example, the size of the granules prepared from three tablet excipients, lactose, glucose, and mannitol, increased when the amount of granulation liquid was increased (24). Similar results were observed for granulating

mixtures of mannitol and MCC (31). When the mixtures were granulated in a high-shear mixer using HPC as the binder, the mean particle size of the granules increased with increasing amounts of water and concentration of the binder.

Generally, an increase in binder concentration could result in the production of larger granules. However, this is not always the case with starch paste since it could behave differently from the other binders. For example, a high-shear mixer was utilized for evaluation of pregelatinized and pregelatinized, cross-linked, waxy corn starches as binding agents in the wet-granulation process (3). Increasing the concentration of the binders decreased the average granule size; however, no difference in friability of the granules was observed. The use of pregelatinized or pregelatinized, cross-linked starches as a paste provided larger and less friable granules than when the binder was added in the dry form.

The effect of starch paste concentrations on the particle size distribution of fine granules, produced by high-speed mixer, was investigated by Makino (32). When a low concentration (5%) of starch paste was used, the growth of granules occurred mainly during the massing time, since a relatively large amount of free water was available from the paste. Only the mean particle size of the granules became larger without changing the particle size distribution of the granules during granulation. However, when a high concentration (15%) of starch paste was used, rapid deaggregation of granules occurred due to the applied shear force, following the formation of large granules, immediately after the addition of the starch paste. Deaggregation of these large agglomerates became predominant during the wet-massing stage, and hence, the size distribution of the granules became narrower. Longer massing time was also required when a high concentration (15%) of starch paste was used, since only a small amount of water exuded from the more concentrated starch paste during the agitation.

Besides the effect on the particle size of the granules, the amount of binder solution used in the wet-granulation process can also affect the content uniformity of the granules. The effects of the amount of binder solution on the content uniformity of the oily drug *D*-alpha-tocopheryl acetate (VE) in granules obtained by high-shear wet granulation was investigated by Kato et al. (33). When the amount of binder solution was below the amount of water required to reach the plastic limit (minimum amount of water required for the powder mixture to form a large agglomerate when kneaded), the content of VE was <50% in the fractionated fine granules, but was >200% in the fractionated large granules. Large variations were seen in the contents of VE even if the granulation time was extended up to 30 min. When the amount of binder solution was at or above the amount of water required to reach the plastic limit, less variation was observed in the content of VE throughout the granules, and the content of VE was fairly uniform.

In another study, the effect of the amount of water as the granulating liquid and HPC as a binder on the pharmaceutical properties of granules of two model drugs, ascorbic acid and ethenzamide, was investigated by Miyamoto et al. (34). The dependence of drug content uniformity of these two model drugs on the granule size was also investigated in this study. For a water-soluble drug, ascorbic acid, an appreciable dependence of drug content on granule size was not observed in model formulations. However, for a poorly water-soluble drug, ethenzamide, more drug was found in small-size granules (<75  $\mu\text{m}$ ). The drug content of ethenzamide in small-size granules decreased with increasing amounts of HPC and granulation liquid. These observations suggested that drug content uniformity is influenced

not only by drug solubility in the binder solution, but also by the amounts of granulation liquid and the type of the binder used.

Granule friability is also influenced by the binder concentration and the amount of granulating liquid added to the formulation during granulation. For a new API granulated with lactose and Avicel PH 101 using low-viscosity HPMC (Pharmcoat 603), increasing the binder concentration and the amount of water tended to produce higher wet-mass consistencies. Granule friability decreased with an increase in the binder level. An inverse relationship was observed between granule friability and the amount of water added to the formulation, especially at lower drug concentrations (35).

The binder can influence not only the physical properties of the granules, but also the performance of the finished tablets. For example, within a certain range of binder concentrations and granulating liquid, increasing the amount of binder or granulating liquid actually decreases the compressibility of the granules (26). In another study, the effect of different types of binders such as PVP K30, HPMC (Cellulose HP-M 603), maltodextrin (Lycatab DSH), pregelatinized starch (Lycatab PGS), and low substituted hydroxypropyl cellulose (L-HPC) (type LH 11) on the hardness of placebo and paracetamol tablets using high-shear granulation technique was compared by Becker et al. (36). The placebo granules comprised only lactose and MCC (Avicel PH 102). The binders were added at 2%, 6%, and 10% in the dry form and water was used as the granulating liquid. The median particle size increased with increasing binder concentrations from 2% to 6% except when L-HPC was used as the binder. The median particle size of the granules decreased with increasing binder concentrations from 2% to 6% when L-HPC was used as the binder. The granule strength, and the hardness (crushing strength and friability) of the resulting tablets increased with increasing binder concentrations. In the preparation of model tablets containing paracetamol, PVP K30 (6%) and Cellulose HP-M 603 (6%) turned out to be the binders of choice with respect to crushing strength of the finished tablets. Lycatab PGS, Lycatab DSH, and L-HPC-LH 11 could not be used to produce paracetamol tablets that met the requirements.

The amount of granulating water can also affect the physical properties and compressibility of MCC, which is one of the most commonly used fillers. The mechanism of forming hard granules with MCC, using a high-shear mixer granulator, was investigated by Suzuki et al. (37). The hardness of the MCC granules increased with granulation time and the amount of water added. The specific surface area decreased during the granulation process. Crystallite size of cellulose decreased with granulation time and with increasing amounts of water added. MCC granules were strengthened with longer granulation time and greater amounts of water, thus resulting in a more intricate network due to the strong shear force of the impeller.

The effect of granulating water level on the physical-mechanical properties of MCC and silicified microcrystalline cellulose (SMCC) was investigated by Habib et al. (38). Granules containing either MCC or SMCC were prepared at different water levels using a high-shear mixer. The resulting granules were tray dried. The water level ranged from 0% to 100%. Increasing the water level affected the granule particle size, increased the granular density and flow properties of the granules, and decreased the porosity and compactibility. The compactibilities of both materials were similar and acceptable at each granulating water level up to 40%. However, both the materials showed poor compactibility at higher water levels. The effect of amount of water used for granulation did not have a statistically significant difference on the compressibility of MCC and SMCC. SMCC did not offer practical advantages over MCC, other than better flow in the powder form, which could be

attributed to slightly larger particle size and the presence of silicon dioxide in its structure.

#### 5.4. Effect of Process Variables

Process variables play a critical role in the granulation process since they influence how the binder liquid is distributed in the powder bed and the degree of densification for the powder mixture. The degree of powder densification affects the level of liquid saturation of the moist agglomerates. Therefore, process variables could influence properties such as particle size distribution and the drug content uniformity of the obtained granules. Specifically, the process variables affecting the granulation process and the physical properties of the obtained granules are:

- Load of the granulator bowl
- Impeller speed
- Granulating solution addition method
- Granulating solution addition rate
- Chopper speed
- Wet-massing time.

The following examples illustrate how varying the aforementioned process variables influences the properties of the granules obtained using a high-shear wet-granulation process.

Processing variables such as impeller speed, granulating solution addition rate, total amount of water added in the granulation step, wet-massing time, etc., were evaluated using a Plackett–Burman experimental design in a study by Badawy et al. (39). The results showed that granule compressibility of the lactose-based formulation is extremely sensitive to the processing conditions. The granule particle size was increased by increasing the amount of water added, high impeller speed, and short wet-massing time. The wet-massing time and impeller speed also had a significant impact on granulation compressibility. Increasing the impeller speed and wet-massing time decreased granule porosity and fragmentation propensity, which led to the decreased hardness of the finished tablets.

The shear effects of the impeller on the properties of granules prepared from surface treated sericite were investigated by Oulahna et al. (40). Surface treated sericite was granulated with an alcoholic solution of polyethylene glycol 20,000 using a high-shear granulator at three different impeller speeds (100, 500, and 1000 rpm). The properties of the granules produced under different impeller speeds were examined in terms of porosity, friability, and binder content. The results indicated that heterogenous granules (in terms of binder concentration) with finer particles and a wider particle size distribution were obtained at a low impeller speed (100 rpm). However, at higher impeller speeds, homogenous granules with less fine particles and a narrower size distribution were observed. Moreover, the porosity of the granules decreased with increasing impeller speeds. Therefore, mechanical energy brought to the powder bed by the impeller is as important as the physicochemical characteristics of the powder–binder pair in affecting the granule properties.

The effect of granulation processing parameters, fill ratios, impeller speed, chopper speed, and wet-massing time on granule size distribution of placebo formulations was studied by Bock et al. (41). High fill ratios in the bowl resulted in an increased proportion of fines in the obtained granules. Increasing the impeller speed



and the massing time increased the granule size. The speed of the chopper did not affect granule size distribution for the formulations tested.

The mode of addition of the liquid binder can affect the characteristics of the granules (42). When water, used as a binder liquid, was added to the powder mixture by atomization, granules with a slightly narrower particle size distribution were obtained.

The effects of massing time on the properties of the granules of hydrophilic polymer-based controlled-release formulations were studied by Timmins et al. (43). The formulations consisted of  $\approx 30\%$  sodium alginate, 10% HPMC, and  $\approx 50\%$  diltiazem hydrochloride or verapamil hydrochloride. The increase in massing time resulted in an increase in the mean granule size of the formulations. This could be true for all the matrix controlled release formulations, which contain a high concentration of the hydrophilic polymers.

The effect of reducing drug loading and mixing time on the content uniformity of a low-dose drug was investigated by Kornchankul et al. (44). Buspirone hydrochloride was used as a model drug and was mixed with other ingredients in two different concentrations (0.5% and 5%, w/w) in a T. K. Fielder high-shear mixer at a high impeller speed (522 rpm) and a high chopper speed (3600 rpm) for up to 32 min. Samples were withdrawn from nine locations in the mixer at specific time points using a side-sampling thief probe. The optimum time to mix the 0.5% w/w formulation was 8 min, while it was only 1 min for the 5% w/w formulation.

MCC was granulated with water in a high-shear mixer (37). The hardness of the MCC granules increased with granulation time and the amount of water added. The specific surface area was reduced during the process. These findings suggested that the long-chain structures in MCC were disrupted, resulting in smaller units with shorter chain lengths due to the strong shear force of the impeller. These smaller units then formed a network within the granules. Thus, MCC granules were strengthened with longer granulation time and greater amounts of water, resulting in a more intricate network. The change in MCC chain length and physical structure can be experimentally detected using the small-angle x-ray scattering and wide-angle powder x-ray diffraction methods.

MCC granules were prepared by wet granulation with water in a high-shear mixer granulator (45). Samples of wet granules were taken at different time points after addition of water to examine the physical characteristics of the granules using near-IR spectrometry, thermogravimetry, and isothermal water vapor adsorption. The results indicated that the degree of interaction between MCC and water increased with granulation time due to the change of physical structure of MCC during the granulation process.

## 5.5. Effect of Granulator Design

A variety of high-shear granulators with varying processing designs are commercially available. The orientation of the mixing chamber in the granulators is either vertical or horizontal. The vertical granulators could be bottom or top driven. Besides the configuration difference, a significant difference exists among the mixers in terms of the shapes of the mixing bowl and impeller blades. For example, the vertical top-driven mixer granulators utilize a curved blade design, thus allowing the tips of the mixing blade to reach the side wall of the mixing bowl, which is also curved in a shape similar to the blade. On the other hand, the vertical bottom-driven high-shear granulators (such as Diosna) have a conical mixing bowl with a flat blade

design. The blade is parallel to the lid and the bottom of the bowl, and only a small portion of the impeller blade directly sweeps off the side wall of the conical mixing bowl. During mixing and granulation, the conical mixing bowl pushes the powder toward the center of the bowl for efficient mixing. The differences in impeller blades and mixing bowl designs of the different commercially available high-shear granulators are expected to result in different flow patterns and powder flow dynamics in the bowl.

During the wet-granulation process, the impellers impact the powder mixture and keep the mixture moving. During this process, binder solution is distributed and the powder mixture is compacted and densified. Relative swept volume, the volume swept out per second by impellor and chopper divided by the volume of the mixer, is the indicator of the work input on the powder material inside the bowl of the granulator. Changes in the granulator design could affect the relative swept volume of the granulation process, which in turn could change the degree of densification of the wet agglomerates. As a result, the optimal amount of granulating liquid and the physical properties of the resulting granules may be altered. Therefore, the design of high-shear granulators must be taken into consideration during the wet granulation process.

Schaefer et al. found that there was a difference between the horizontal (Lödige M5GR) and vertical (Fielder PMAT 25 VG) granulators in terms of granule growth for DCP (22). The degree of liquid saturation required was higher for the vertical (Fielder PMAT 25 VG) granulator in order to obtain the same granule size. Agglomeration of DCP began at lower degrees of liquid saturation in the horizontal (Lödige M5GR) granulator. This could be because the rolling motion of granules in the horizontal (Lödige M5GR) granulator facilitated agglomeration, whereas stronger mechanical forces in the vertical (Fielder PMAT 25 VG) granulator promoted the breakage of granules. A similar trend was observed for lactose granulation (46) as well.

The effects of impeller and chopper design upon granule growth of DCP in a laboratory high-speed mixer (Fielder PMAT 25) were investigated by Holm (47). Three different changeable impeller blades with the same surface area were constructed. The angles of inclination were kept at 30°, 40°, and 50°. The granules with low porosity were obtained at high impeller speed for the inclination angles at 40° and 50°. The effects of the impeller design with respect to the blade inclination and impeller rotation speed can be explained in terms of the volume of powder mixture swept out by the impeller. The relative swept volumes for the impellers at three different inclination angles were 2.2, 2.82, and 3.36 at 400 rpm. A high-swept volume causes high densification of the agglomerates and narrow granule size distributions. Chopper size and rotation speed had no effect on the granule size distribution because the primary function of the chopper is to disturb the uniform flow pattern of the mass.

## 6. GRANULATION END-POINT DETERMINATION

The granule properties for a given formulation are a function of the process parameters such as the impeller speed, amount of granulating fluid, and granulation time (wet-massing time). Therefore, the time to end the granulation process during a high-shear granulation process becomes critical. The properties of the granules produced determine, in part, the ultimate quality and performance of the finished dosage

forms. Thus, the determination of the granulation end point becomes necessary. The ultimate goal of end-point determination in a granulation process is to obtain an indication of formation of granules with the desired physical properties, such as acceptable mean particle size range and porosity. The measurements of changes during the granulation process are employed for end-point determination. The advantages of using an appropriate method to determine the granulation end point are listed below:

- Process optimization
  - Evaluate raw material
  - Determine optimal end point
- Batch reproducibility
  - Use end point to achieve batch to batch consistency
  - Document adherence to batch protocol
- Process trouble shooting
  - Detect mechanical problems
  - Identify mixing irregularities

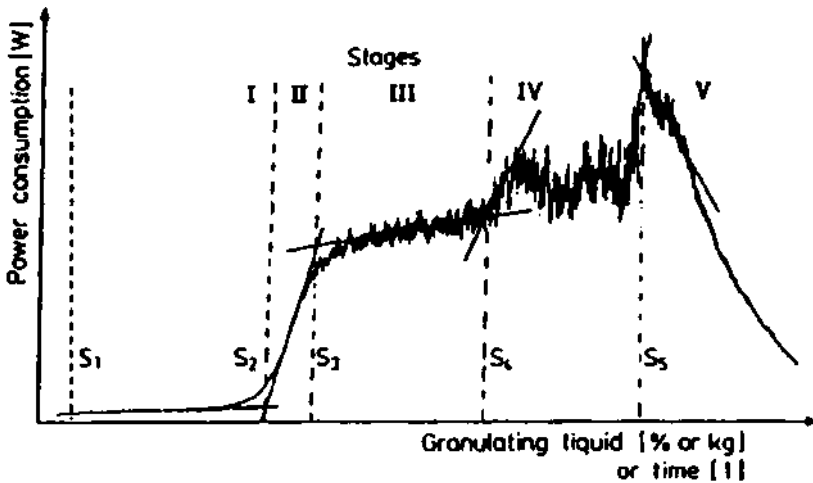
Several different approaches have been explored for granulation end-point determination. These approaches can be classified into two major categories: indirect measurements and direct measurements. In the indirect measurements, the electrical and mechanical parameters of the granulator motor are monitored since the changes of these parameters are related to the changes in the consistency of the powder mixture in the wet granulation process. Faure's study (48) has confirmed that there is a close relationship between the wet-mass consistency/viscosity of samples prepared in a mixer granulator and physical properties of the dry granules produced from the wet mass. The physical properties of the dry granules include granule size distribution, bulk density, friability, and flow characteristics. Variations in the formulation and process affect the relationships between the wet-mass consistency and dry-granule properties, and the net power consumption of the mixer granulator.

In the direct measurements, the physicochemical properties of the powder mixture are monitored during the wet-granulation process. These properties could be mass conductivity and granule size.

### 6.1. Indirect Measurements

In the indirect measurement, both electrical and mechanical characteristics of the motor are monitored to control the granulation end point. The electrical characteristics of the motor are motor current and power consumption. The mechanical characteristics of the motor are torque and tachometry.

The power consumption of a granulator motor is related to the resistance of the mass mixture to the granulator blades, which varies with the consistency of the powder mixture. Power consumption used as granulation end point control has been related to the level of liquid saturation of the moist agglomerates (49), densification of wet mass (30,50,51), and granule growth (52). Leuenberger proposed that the liquid amount required for granulation corresponds to the plateau in the power consumption record profile (53).



**Figure 12** A typical power consumption profile obtained from a commercially available high shear granulator. (From Ref. 53.)

High-shear granulators capable of monitoring the granulation end point using power consumption are commercially available. Figure 12 shows a typical power consumption profile obtained from a commercially available high-shear granulator with an end-point determination (53). It is evident that the profile consists of five phases during the wet granulation process. In Phase I, the powder mixture is moistened by adding the granulation liquid. Since the formation of liquid bridges is not observed between primary particles, power consumption does not increase during this granulation phase. In Phase II, the liquid bridges begin to form among the primary particles, thus resulting in granule formation. The power consumption increases dramatically in this phase. In Phase III, as more granulation liquid is added, the interparticular voids are filled by the granulation liquid and coarser granules are formed. The power consumption remains relatively constant in this phase. In Phase IV, liquid saturation of the powder bed is reached, and more coarse granules are formed. The power consumption increases in this phase. In Phase V, as more granulation liquid is added, a suspension is formed. The power consumption starts declining in this phase. It has been noticed that only the granules formed during Phase III are usable for further dosage form development. Thus, the power consumption profile can be used to monitor the granulation process and to determine the granulation end point.

The drawback of monitoring power consumption is that the signal is affected by a number of factors, such as product (formulation), equipment, or process variables. For example, the densification properties of the starting materials, type and amount of binder used, addition rate of binder solution, impeller speed, etc., influence the power consumption profile. Wear and tear of the granulator could also affect the power consumption signal. Thus, the power consumption profile for a granulation process is formulation and process specific.

The end-point control of granulation by power consumption measurement in a 25 L high-shear mixer was investigated by Holm et al. (42). The effect of impeller design, impeller speed, liquid addition rate, type of binder, and mixing ratios between lactose and starch on the correlation between power consumption and granule

growth was investigated in the liquid addition phase of the process using a fractional factorial experimental design. A linear correlation between power consumption and mean granule size was observed. The correlation was dependent on the impeller design, the impeller speed, and the type of binder. However, a granulation end-point control, based on power consumption was not found to be sensitive to variations in the lactose:starch ratio. An end-point control based on the peak detection method was not generally applicable, because a peak in the differentiated power consumption signal could not be identified in all the experiments.

Monitoring of power consumption was also explored for automating the wet-granulation process (54). A vertical high-shear mixer (300 L Collette Gral) was instrumented with a control unit, which controls the continuous addition of granulating liquid in relation to the consistency of the powder mass by power consumption measurement. The instrumentation comprised an important approach for automated process control, and on-line documentation of critical process parameters with respect to validation. Similarly, a signal analysis system with memory-programmable automatic process control for determining power consumption in a high-shear mixer was introduced by Laicher et al. (55). The signal analysis system made it possible to perform gliding mean value calculations of the measuring signal and to evaluate the signal fluctuations. The granulation end point was determined by curve analysis. Using this system, granules with a reproducible particle size distribution were obtained from active ingredient paracetamol or ibuprofen/excipient mixtures, which either showed a tendency to form lumps, in the case of overwetting (paracetamol), or required a short granulation time due to low melting point (ibuprofen).

Since power consumption is related to both current and voltage of the motor, it would be logical to use motor current for granulation end-point control. However, the motors used in high-shear granulators are induction motors, which use alternating current that lags behind the voltage. Therefore, it is inappropriate to determine granulation end point by monitoring motor current or the simple combined product of current and voltage (51). The power consumption of induction motors can be expressed by the following equation:

$$\text{Power} = \sqrt{3} IV \cos \theta \quad (6.1)$$

where  $I$  is the current,  $V$  is the voltage, and  $\theta$  is the phase difference between current and voltage.

An alternative to power consumption is torque measurement. A high-shear mixer was instrumented with a new capacitive sensor, a watt meter, and a strain-gauge torque sensor (50). Placebo formulations containing DCP, MCC 101, MCC 102, and lactose were granulated in the high-shear granulator. A similar map (profile of torque measurement or power consumption) of the granulation process was obtained for power consumption and torque measurement.

In another study (51), a high-shear vertical mixer/granulator was instrumented to monitor power consumption, direct torque (signal from impeller shaft), and reactive torque (signal from the motor). Of the three methods used, direct torque generated the most descriptive profile for the granulation process. Granules produced for the test formulations, based on the end points determined using direct torque measurement, resulted in tablets with acceptable hardness. Measurement of direct torque could also detail the granulation process of an overwetted formulation.

Torque profiles of granulation of MCC or lactose in a high-shear granulator with various operating conditions were studied by Kornchankul et al. (56). The

torque measurement for each batch of granules obtained was correlated with the corresponding tablet characteristics. The scatter plots of tablet hardness indicated that the hardness of tablets prepared with MCC granules was  $>7$  Kp, as long as the end torque was  $<100$  lb in., granulation rate was  $<0.4$  lb in./sec, and granulation extent was  $<13,000$  lb in. sec.

The relevance of end-point determination based on torque measurement in controlling performance characteristics of compressed tablets such as hardness, friability, disintegration time, and dissolution time was determined by Achanta et al. (57). The measurement of torque was used to determine the end point of the granulation process in a high-shear granulator. With increasing end-point levels, tablets compressed with the corresponding granules were found to be harder.

## 6.2. Direct Measurements

During the high-shear wet-granulation process, the binder liquid is dispersed in the powder mixture. At this point, the wetted powder becomes agglomerated and densified. Thus, the physical properties (particle size, density, consistency) of the powder mixture change with time during the granulation process. This change in the properties of the powder mixture can be used as an indication of the end point of the granulation process.

## 6.3. Consistency Measurement Using a Probe

One approach to determine the granulation end point is based on monitoring the change of the consistency or strength of the wet mass during the granulation process. This approach was first developed by the Boots Company for Diosna high-shear mixers (18). The Diosna-Boots probe is designed to detect changes in the momentum of granules, in a constant velocity region of the mass, with the use of strain gauges mounted on the probe. To avoid bias due to random events (e.g., production of large lumps due to inhomogenous solution distribution), signal pulse heights, sampling times, and pulse density are all considered to attain the final signal. The signal is normalized over a calibrated range of forces from 0% to 100%. The criterion for end-point indication is that the signal obtained during the granulation process must be greater than the preset value. When properly developed and calibrated for a given high-shear granulator, the probe can be successfully used to determine a repeatable granulation end point, i.e., granules with a similar particle size and density are obtained. However, the signal obtained from the probe is granulator and formulation dependent.

## 6.4. Acoustic Emission

Acoustic emission monitoring detects and analyzes the sound produced by a process or system. During the wet-granulation process, particle size, flow properties of the powder mixture, and degree of powder densification change with time because of the addition of binder and formation of agglomerates. The change of physical properties of the powder mixture could affect the acoustic emission signal. Thus, this technique can be used to map the granulation process and determine its end point. The technique is noninvasive, sensitive, and relatively inexpensive.

The acoustic emissions during the wet granulation of a model formulation containing lactose and MCC were monitored using acoustic emission sensors (58). The

sensors were attached to the outside of the high-shear mixer bowl. Undergranulated to overgranulated granules were prepared by varying the quantity of the binder solution. Average signal level increased with increasing amount of the added binder solution and wet-massing time. A strong correlation between the acoustic emissions and the physical properties of the granules at the end of the granulation process was demonstrated. This technique was capable of monitoring changes in physical properties such as particle size, flow properties, and compression properties of powder material during granulation.

### 6.5. Image Analysis

In the direct measurement techniques, one of the successful methods is monitoring the granulation processing based on the particle size of the granules.

A novel system to continuously monitor granule growth in a high-shear granulation has been developed by Watano et al. (59). The system consists of an image processing system and a particle image probe comprising a CCD camera, lighting unit, and air purge system. High-shear granulation was conducted using pharmaceutical powders, and granule size and product's yield of various size ranges were continuously measured by the developed system. Sieve analysis of the granules sampled out during the granulation was simultaneously conducted, and the data were compared with that of the on-line image processing system. A close relationship was found between both the data, thus proving that the system could monitor the granule growth accurately and continuously throughout.

Such an image processing system was further developed to automatically control the wet-granulation process by Watano et al. (60). Besides the image probe, a fuzzy control system using a linguistic algorithm employing "if-then" rules with a process lag element was developed to control granule growth accurately. The system consisted of an image processing and a fuzzy control system. An image probe continuously monitored granule images through the sidewall of the vessel. The images were digitized by the image processing system, and granule median diameter and shape factor were calculated automatically. The difference between the desired and measured granule diameters was used as an input for fuzzy reasoning. The result of fuzzy reasoning was used to control the output power of the liquid feed pump. The system could control granule growth with high accuracy, regardless of changes in the operating conditions.

## 7. FORMULATION DEVELOPMENT (OPTIMIZATION)

The pharmaceutical properties of the granules, which can significantly affect the performance and properties of the finished dosage forms are controlled by multiple interrelated variables such as formulation, process, and granulator parameters. In most cases, the nature and characteristics of the excipients and API used in the formulation are fixed. Thus, only the amount of granulating liquid and granulation process variables need to be optimized. "Design of experiment (DOE)" is often used to optimize the granulation process. In experimental designs, a number of cause factors which comprise volume of binder solution, impeller speed, massing time, etc., and response variables (dependent variables), which comprise mean particle size, tablet hardness, time for 50% of drug released, etc., are selected. The relationship between

cause variables and response variables is established mathematically. The optimal response variables can then be obtained by selecting the optimal cause variables.

A Box-Behnken design was used to optimize the composition and process factors for formulations containing mannitol and MCC, which were granulated in a high-shear mixer and compressed into tablets (31). Simultaneous optimization of crushing strength, disintegration time, and ejection force of the tablets was carried out to find optimal regions in the design space for these tablet properties. The composition of the tablet mixture and the process of tablet manufacturing were optimized using such statistical techniques.

A central composite experimental design was used to optimize a granulation process in a high-shear mixer for a hydrophilic matrix tablet formulation (61). The parameters tested were the amount of water in the hydroalcoholic granulation liquid, the amount of granulation liquid, and the massing time. The results indicated that the amount of granulation liquid was the most important parameter, followed by the amount of water in the granulation liquid. The influence of the massing time was negligible. A formulation with granule friability below 20% was obtained under optimal processing conditions.

The wet-granulation process by a high-speed mixer granulator for two model drugs, ascorbic acid and ethenzamide, was optimized through experimental design (spherical central composite experimental design) and simultaneous optimization methodology (34). The amount of water (granulation liquid) and HPC (binder) were simultaneously optimized with regard to the four pharmaceutical properties, including yield, drug content uniformity, geometrical mean diameter of granules, and uniformity of granule size. A simultaneous optimal point incorporating four pharmaceutical properties was obtained using the generalized distance function. The experimental values of the four response variables obtained in newly prepared granules were found to correspond well with the predicted values of granules containing both ascorbic acid and ethenzamide.

Various experimental designs have been explored by Vojnovic et al. to optimize wet-granulation process variables. Some of these examples are described below.

Wet granulation of lactose and corn starch in a 10 L high-shear mixer was optimized using a response surface design (62). The effect of the process factors, impeller speed, amount of water added, and granulation time on the properties of the granules were investigated. Moisture level had a major effect on geometric mean diameter and flow rate of the granules. The impeller speed markedly influenced the geometric mean diameter, geometric standard deviation, compactibility index, and percentage of granules smaller than 1250  $\mu\text{m}$ . The granulation time affected the compactibility index of the granules. Theoretical optimum conditions were obtained for the following five response variables: geometric mean diameter, geometric standard deviation, flow rate of the granules, percentage of granules smaller than 1250  $\mu\text{m}$ , and compactibility index. These results were comparable to the experimental results.

A central composite response surface design was employed to optimize a wet-granulation process for lactose and corn starch in a 10 L high-shear mixer (63). The effect of the optimal combination of three independent variables (moisture level, impeller speed, and granulation time) on four properties (geometric mean diameter, percentage of particles smaller than 1250  $\mu\text{m}$ , geometric standard deviation, and flow rate) of the granules was investigated by the simultaneous optimization method. The optimum zone determined in 10 L high-shear mixer was analyzed for scale-up. The same product was manufactured at a 50 L scale and optimum theoretical results were



obtained for the four response variables. These results were in agreement with the experimental data.

Optimization of wet granulation of a placebo formulation in a 10 L high-shear mixer was carried out using an experimental design, which combined the Scheffe simplex-centroid design and Doehlert experimental matrix (64). Lactose, corn starch, and MCC were used as excipients. Mixing ratios of these excipients were selected as formulation factors. The impeller speed and granulation time were chosen as independent variables. A two-phase experimental strategy was employed. The optimal composition of the three excipients was determined in the first phase and the optimal process conditions to obtain a geometric mean diameter  $>150\ \mu\text{m}$  was determined in the second phase.

The optimization of wet granulation in a 10 L high-shear mixer was investigated using a nonclassical mixture experimental design, which combines mixture experimental design with the ponderation function (65). HPMC, lactose, corn starch, and MCC were used as excipients, while PVP was used as a binder. The introduction of such a modification in the experimental design allowed selection of an experimental matrix, which could provide enough information with a relatively low number of experiments and at a minimal cost.

## 8. PROCESS SCALE-UP

The formulation and process for a new API are normally optimized using small-scale equipment, owing to a limited amount of API. The granulators used during the development stage are laboratory scale models. The formulation is generally fixed during the clinical trial studies. However, the production batches are manufactured with large-scale equipment. For a solid dosage form prepared using the wet-granulation process in a high-shear granulator, product scale-up could be challenging. This is because of significant differences between laboratory and production models of high-shear granulators in terms of the design, shape, size, and geometry of the impellers. Even though the composition of the formulation is similar, the physical properties of the obtained granules could be dramatically different because of the differences between laboratory scale and production scale granulators. These differences in the physical properties of the granules could significantly affect the properties and performance of the final tablets.

The ultimate goal of product scale-up is to maintain similar processing conditions for the production batches as those used at the laboratory scale so that the properties of the granules produced after scale-up would not change significantly. Therefore, it is imperative to identify and monitor key process parameters during the product development stage, so that the tablets produced from the large-scale granulation batch perform similarly to those produced from the small-scale batch.

The liquid saturation level of the agglomerates during a high-shear wet-granulation process plays an essential role in terms of granule growth, as discussed previously. It is desirable to maintain a constant level of liquid saturation during the scale-up. From Eq. 4.1, liquid saturation level is controlled by both moisture content and intragranular porosity. The moisture content is determined by the amount of applied granulation liquid. The intragranular porosity is affected by the impaction caused by the impeller and wet-massing time. Due to the different geometric shapes and sizes of the granulator and impeller, and fill ratio in the mixing bowl, maintaining constant liquid saturation level could be problematic.

## 8.1. Linear Scale-up

As described earlier, the process and formulation factors that affect the granulation process and physical properties of the obtained granules are: rate of addition of the binder solution, impeller speed, wet-massing time, and the amount of binder or granulating liquid used. Ideally, the amount of binder and granulation liquid will be scaled up by linearly increasing the amount of water with the batch size. If the time of binder solution addition is kept constant by increasing the rate of binder addition during scale-up, then the variables that need to be controlled narrow down to impeller speed and wet-massing time. Different approaches have been proposed to control impeller speed. These approaches include maintaining a constant impeller tip speed, maintaining a constant relative swept volume, or maintaining a constant Froude number (dimensionless number) during the scale-up process. The wet-massing time can be determined by the granulation end-point determination such as power consumption. However, due to the difference in the size and shape of the mixing bowl and impeller between laboratory and production scale granulators, linear scale-up may not work.

A constant relative swept volume and a constant impeller tip speed during the granulation of lactose in three Gral high-shear mixers (Gral 10, 75, and 300 L), did not result in a comparable process for different sizes of granulators (66). Thus, even within the same type of high-shear granulators, compensatory changes in the volume of binder fluid, impeller speed, and wet-massing time to produce equivalent granules during scale-up may be required.

The ease of scale up could be formulation dependent, and some formulations are not affected by the batch size. If the formulation is easy to densify, then the speed of the impeller may not affect the properties of the obtained granules. In one study (67), alpha-lactose monohydrate was granulated using a PVP K 30 (2.5% on dry material) binder solution. The wet granulation process was optimized in a Gral 10 L granulator using a two-factor (water content and impeller tip speed), three-level experimental design. The granulation process was then scaled down from a Collette Gral 10 L (8 L batch size) to a serial minigranulator (Pro-C-epT Mi-Pro) with different bowl volumes of 5 L, and 1900, 900, and 250 mL. In all mixer volumes, the impeller tip speed range used did not influence the granule or tablet properties. In all bowl volumes, the influence of water concentration on actual yield, particle size distribution, and granule friability was similar.

In another study, the formulation containing 5% API, 47.35 % of MCC, and 47.35% of pregel starch was granulated using different sizes of high-shear granulator ranging from 2 to 25 L (68). A 2<sup>3</sup> factorial design was used to investigate the effects of scale-up variables including amount of binder solution, wet-massing time, and impeller tip speed on the physical properties of the obtained granules. It was shown that the characteristics of the granulations made under different conditions were highly reproducible. The excipient system of MCC and pregel starch produced a robust formulation that was resistant to changes during the scaling-up process in the high-shear mixers.

Unfortunately, most formulations are not scalable. For example, a less homogeneous liquid distribution, a wider granule size distribution, and a higher intragranular porosity of the obtained granules were found for the scale-up batches when DCP was granulated using different sizes of high-shear granulator. This could be due to the decreased swept volume in the larger granulator during scale-up (18).

In another study, a model formulation was developed in a small-scale high-shear granulator (Diosna P 1-6) (41). It was easy to scale up to the P 10 granulator without changing the formulation or the granulation conditions. However, further scale-up to Diosna P 25 and P 100 granulators, which are large-scale machines, resulted in granules which were smaller than those prepared in the laboratory scale equipment.

To achieve linear scale-up for formulations that are sensitive to the changes during the scale up, the parameters used during the laboratory scale granulation process have to be similar to those used during the production scale process. Two processes may be considered similar if there is a geometrical, kinematic, and dynamic similarity (69). Two systems are considered to be geometrically similar if they have the same ratio of linear dimensions. Two geometrically similar systems are kinematically similar if they have the same ratio of velocities between corresponding points. Two kinematically similar systems are dynamically similar when they have the same ratio of forces between corresponding points. For any two dynamically similar systems, all the dimensionless numbers necessary to describe the process are the same (70). Dimensionless number of the process is scale independent, and thus can be employed for scale-up of granulation.

Dimensional analytical procedure was first introduced by Lord Rayleigh in 1915 (71). It is a process whereby the variables pertinent to a physical problem are systematically organized into dimensionless groups/numbers. Assuming the absence of chemical reaction and heat transfer, the following influencing and independent variables are pertinent to the wet-granulation process (72):

$\Delta P$ : net impeller power consumption (motor power consumption minus the dry blending baseline level)

$R$ : impeller radius

$N$ : impeller speed

$h$ : height of granule bed in the bowl

$\rho$ : granule bulk or specific density

$\eta$ : granule dynamic viscosity

The only three fundamental quantities are mass ( $M$ ), length ( $L$ ), and time ( $T$ ).

Buckingham theorem ( $\pi$ -theorem) (73) states that when there are  $i$  physical variables and dimensional constants and  $j$  fundamental qualities (such as mass, length, and time), the number of dimensionless groups/numbers in a complete set is equal  $i - j$ .

Therefore, according to the Buckingham theorem, there are four dimensionless numbers for a high-shear granulator.

Newton (power) number ( $N_p$ ) relates the drag force acting on a unit area of the impeller to the inertial stress:

$$N_p = \frac{\Delta P}{\rho N^3 R^5} \quad (8.1)$$

Reynolds number ( $Re$ ) relates the inertial force to the viscous force:

$$Re = \frac{\rho N R^2}{\eta} \quad (8.2)$$

Froude number ( $Fr$ ) is the ratio of the centrifugal acceleration to the gravitation constant ( $g$ ). It can be used as a criterion for dynamic similarity of granulators:

$$Fr = \frac{RN^2}{g} \quad (8.3)$$

Geometric number (ratio of characteristic lengths)  $h/R$  is related to fill level in the bowl.

An ideal scenario is that the granulation processes in laboratory scale and production scale granulators are geometrically, kinematically, and dynamically similar. However, the shape and size of granulators currently available vary from manufacturer to manufacturer. Therefore, it is difficult for the granulation processes to be geometrically, kinematically, and dynamically similar. For example, Collette Gral 10, 75, and 300 are not geometrically similar (66).

One practical approach during scale-up is to keep the processes dynamically similar, which is defined by the same dimensionless numbers for the two different sizes of granulators. Therefore, dimensionless numbers such as Froude number can be used for scale-up.

Froude number was suggested as a criterion for dynamic similarity and a scale-up parameter during wet granulation (66). Lactose granules prepared in Gral high-shear mixers of three different capacities (Gral 10, 75, and 300 L) were compared. The granulation process regarding temperature increase and particle size distribution could be scaled up by keeping the Froude number constant. It therefore seems appropriate to characterize and compare different mixers by the range of the Froude numbers. A matching range of the Froude numbers would indicate the possibility of scaling up the batch even for the mixers such as Collette Gral 10, 75, and 300 that are not geometrically similar. Hence, systematic consideration is needed to select laboratory and high-production scale granulators to develop a solid dosage form, which requires high-shear granulation in the manufacturing process. The Froude numbers of each granulator can be calculated based on Eq. 8.3. If the Froude numbers for the laboratory scale granulator cannot be matched, linear scale-up is unlikely.

Dimensionless power relationship between power number and the product of Froude number, Reynolds number, and fill ratio could be another approach for scale-up (74). A model formulation granulated in different conditions (batch size, blade speed) with different sizes of high-shear granulators, but presenting similar wet-mass characteristics (bulk density and consistency) led to dry granules of similar properties such as granule size distribution, density, friability, and flow. The wet masses were characterized by the bulk density and consistency, as measured by mixer torque rheometry. The power consumption of the granulator was monitored with a power meter. The power number, Reynolds number, Froude number, and bowl fill ratio were calculated for each running condition. The relationship between the power number and the product of Reynolds number, Froude number, and bowl fill ratio can be established by plotting the decimal logarithms of power number vs. the decimal logarithms of the product of Reynolds number, Froude number, and bowl fill ratio. The results showed that under certain conditions, a common scale-up master curve could be drawn from the data gathered for each bowl, and such a curve could be used for the determination of power consumption of a mixer granulator at a defined granulation end point for scale-up.

Dimensionless numbers such as Froude number can also be used to design and select high-shear granulators of different scales. It is therefore necessary to characterize and compare high-shear granulators of different types and sizes by the range of

the Froude numbers. A matching range of the Froude numbers would indicate the possibility of a scale-up, even for the mixers that are not geometrically similar (66). Froude number of a granulator is determined by both impeller speed and the diameter of the impeller as shown in Eq. 8.3. When the diameter of the impeller is fixed, the Froude number of a granulator can still be varied by adjusting the impeller speed. Therefore, it would be desirable for the production scale granulator to be equipped with variable speeds. Hence, the range of Froude numbers for each size of granulator needs to be considered in the design of the high-shear granulators. A systematic approach should be followed to select laboratory scale and production scale granulators.

The matching Froude numbers for different size granulators provide the possibility of linear scale-up. However, some precautions are still needed for the geometric dissimilarity of mixing bowl vessels, and the shape of the impellers in the granulators of different types and scales.

During scale-up, after selecting the granulator with matching Froude number and similarly shaped impeller blades, the granulation end point can be determined by any one of the techniques described earlier. A new approach for scale-up based on the use of power consumption, as the granulation end-point determination, is shown below.

Integration of the impeller power (watts) vs. time (seconds) profile for high-shear granulator was also explored for scale-up of high-shear granulation (75). The energy parameter impeller work during the wet-granulation process of a model MCC formulation in 5 or 10 L was recorded and normalized, based on the weight of the dry powder mixture. The relationship between work of granulation and cohesion indexes (slopes of the tablet breaking strength vs. compression force profiles), or granulation size distributions was evaluated. Independent of granulator make or model, the impeller work measured during granulation correlated quantitatively with changes in the granulation bulk and tapped densities, average particle size of the finished powders, and cohesion index. Granulation end points were accurately predicted for 25, 65, and 150 L high-shear granulators on the basis of development work on 5.0 and 10 L equipment using impeller work values normalized for the weight of dry powders in the granulator ( $W \text{ sec/g}$ ).

## 8.2. Nonlinear Scale-up

If linear scale-up cannot be achieved, the amount of binder solution, the impeller speed, and the wet-massing time should be optimized. For example, Kristensen attempted to compensate the less efficient mixing from large-scale granulation by increasing the relative amount (ratio between granulation liquid and starting materials) of granulation liquid used (76). Rekhi et al. recommended maintaining a constant tip speed, scaling up the granulation liquid linearly, and adjusting the granulation time based on the ratio of impeller speeds between the granulators used in both the scales (77).

## 8.3. Utilization of Optimization Techniques

Since scale-up of high-shear granulation is still a “trial and error” process due to the complexity of the granulation process and lacks standards for granulators of different types and sizes, the DOE approach can be useful during production. The process variables for the large-scale production can be optimized by using the DOE

technique with relatively less number of trials. Alternatively, the granulation process can be optimized in such a way that the process is scale independent.

A spherical central composite experimental design was used to design experiments (78). Granules were prepared in the two batches (2 and 5 kg batches) using a high-speed mixer granulator. Except for the rotation speed of the impeller, the operation conditions such as chopper speed, mixing time, and granulation time were kept constant during the granulation processes. The concentration of ethanol in the aqueous binder solution and the total volume of binder solution used were selected as independent variables. The yield of granules, geometric mean particle size, and geometric standard deviation were employed as dependent variables. A computerized optimizing technique based on a response surface methodology was developed. A universal optimal formulation unaffected by manufacturing scale could be obtained by minimizing the integrated optimization function. The optimized characteristics measured at the production scale coincided well with those obtained at laboratory scale, suggesting that this approach could be useful in minimizing the scale-up problems.

## 9. CONCLUSION

High-shear granulation is one of the most important unit operations in the production of tablets. Various innovative approaches have been explored to simplify and control the granulation process, and improve the quality of the produced granules. Some of these novel approaches include using a one-pot granulation system, moisture-activated dry granulation and hot-melt granulation techniques, and different granulation end-point techniques. However, both the process and formulation parameters for each formulation still need to be individually optimized due to the complexity of the number of variables involved during the granulation process and the uniqueness of the formulation. Moreover, the relationship between the properties of the finished tablets and unit operations for tableting, such as wet granulation, drying, milling, and tablet compression, is inconclusive. Therefore, a systematic evaluation of all formulation and process variables involved in the manufacturing of tablets is required for the optimization of production of tablets. Future advancement in the equipment and granulation techniques could further improve the granulation process, thus resulting in better quality of the granules.

## REFERENCES

1. Nellore RV, Rekhi GS, Hussain AS, Tillman LG, Augsburger LL. Development of metoprolol tartrate extended-release matrix tablet formulations for regulatory policy consideration. *J Control Release* 1998; 50:247–56.
2. Qiu Y, Hui HW, Cheskin H. Formulation development of sustained-release hydrophilic matrix tablets of zileuton. *Pharm Dev Technol* 1997; 2:197–204.
3. Visavarungroj N, Remon JP. Crosslinked starch as a binding agent. II. Granulation in a high shear mixer. *Int J Pharm* 1990; 65:43–48.
4. van den Dries K, de Vegt OM, Girard V, Vromans H. Granule breakage phenomena in a high shear mixer; influence of process and formulation variables and consequences on granule homogeneity. *Powder Technol* 2003; 133:228–236.

5. Kiekens F, Cordoba-Diaz M, Remon JP. Influence of chopper and mixer speeds and microwave power level during the high-shear granulation process on the final granule characteristics. *Drug Dev Ind Pharm* 1999; 25:1289–1293.
6. Christensen LH, Johansen HE, Schaefer T. Moisture-activated dry granulation in a high shear mixer. *Drug Dev Ind Pharm* 1994; 20:2195–2213.
7. Schaefer T, Holm P, Kristensen HG. Melt granulation in a laboratory scale high shear mixer. *Drug Dev Ind Pharm* 1990; 16:1249–1277.
8. Schaefer T, Holm P, Kristensen HG. Melt pelletization in a high shear mixer. II. Power consumption and granule growth. *Acta Pharm Nordica* 1992; 4:141–148.
9. Schaefer T, Holm P, Kristensen HG. Melt pelletization in a high shear mixer. I. Effects of process variables and binder. *Acta Pharm Nordica* 1992; 4:133–140.
10. Schaeferand T, Mathiesen C. Melt pelletization in a high shear mixer. IX. Effects of binder particle size. *Int J Pharm* 1996; 139:139–148.
11. Schaeferand T, Mathiesen C. Melt pelletization in a high shear mixer. VIII. Effects of binder viscosity. *Int J Pharm* 1996; 139:125–138.
12. Schaefer T, Taagegaard B, Thomsen LJ, Kristensen HG. Melt pelletization in a high shear mixer. V. Effects of apparatus variables. *Eur J Pharm Sci* 1993; 1:133–141.
13. Schaefer T, Taagegaard B, Thomsen LJ, Kristensen HG. Melt pelletization in a high shear mixer. IV. Effects of process variables in a laboratory scale mixer. *Eur J Pharm Sci* 1993; 1:125–131.
14. Plank R, Diehl B, Grinstead H, Zega J. Quantifying liquid coverage and powder flux in high-shear granulators. *Powder Technol* 2003; 134:223–234.
15. van den Dries K, Vromans H. Relationship between inhomogeneity phenomena and granule growth mechanisms in a high-shear mixer. *Int J Pharm* 2002; 247:167–177.
16. Kristensen HG. Agglomeration of powders. *Acta Pharm Suecica* 1988; 25:187–204.
17. Kristensen HG, Holm P, Jaegerskou A, Schaefer T. Granulation in high speed mixers. Part 4: effect of liquid saturation on the agglomeration. *Pharm Ind* 1984; 46:763–767.
18. Kristensenand HG, Schaefer T. Granulation. A review on pharmaceutical wet-granulation. *Drug Dev Ind Pharm* 1987; 13:803–872.
19. Yajima T, Itai S, Hayashi H, Takayama K, Nagi T. Optimization of size distribution of granules for tablet compression. *Chem Pharm Bull (Tokyo)* 1996; 44:1056–1060.
20. Wikbergand M, Alderborn G. Compression characteristics of granulated materials. IV. The effect of granule porosity on the fragmentation propensity and the compactibility of some granulations. *Int J Pharm* 1991; 69:239–253.
21. Schaefer T, Holm P, Kristensen HG. Wet granulation in a laboratory scale high-shear mixer. *Pharm Ind* 1990; 52:1147–1153.
22. Schaefer T, Holm P, Kristensen HG. Comparison between granule growth in a horizontal and a vertical high speed mixer. I. Granulation of dicalcium phosphate. *Arch Pharm Chem, Scientific Edition* 1986; 14:1–16.
23. Vromans H, Poels-Janssen HG, Egermann H. Effects of high-shear granulation on granulate homogeneity. *Pharm Dev Technol* 1999; 4:297–303.
24. Juppo AM, Yliruusi J, Kervinen L, Strom P. Determination of size distribution of lactose, glucose, and mannitol granules by sieve analysis and laser diffractometry. *Int J Pharm* 1992; 88:141–149.
25. Suzuki T, Watanabe K, Kikkawa S, Nakagami H. Effect of crystallinity of microcrystalline cellulose on granulation in high-shear mixer. *Chem Pharm Bull (Tokyo)* 1994; 42:2315–2319.
26. Chowhan ZT. Aspects of granulation scale-up in high shear mixers. *Pharm Technol* 1998; 12:26–44.
27. Badawy SIF, Lee TJ, Menning MM. Effect of drug substance particle size on the characteristics of granulation manufactured in a high-shear mixer. *AAPS Pharm Sci Tech* 2000; 1.
28. Vertommen J, Michoel A, Rombaut P, Kinget R. Production of pseudoephedrine hydrochloride pellets in a high-shear mixer granulator. *Eur J Pharm Biopharm* 1994; 40:32–35.

29. Ritala M, Jungersen O, Holm P, Schaefer T, Kristensen HG. A comparison between binders in the wet phase of granulation in a high shear mixer. *Drug Dev Ind Pharm* 1986; 12:1685–1700.
30. Ritala M, Holm P, Schaefer T, Kristensen HG. Influence of liquid bonding strength on power consumption during granulation in a high shear mixer. *Drug Dev Ind Pharm* 1988; 14:1041–1060.
31. Westerhuis JA, de Haan P, Zwinkels J, Jansen WT, Coenegracht PJM, Lerk CF. Optimization of the composition and production of mannitol/microcrystalline cellulose tablets. *Int J Pharm* 1996; 143:151–162.
32. Makinoand T, Kitamori N. Effect of starch paste concentration on particle size distribution of fine granules produced by agitation granulation. *Chem Pharm Bull (Tokyo)* 1995; 43:1231–1233.
33. Kato Y, Moroshima K, Hashizume M, Ando H, Furukawa M. Further observation of content uniformity of d-alpha-tocopheryl acetate as an oily drug in granules obtained by wet granulation with a high-shear mixer. *Drug Dev Ind Pharm* 2001; 27:781–787.
34. Miyamoto Y, Ryu A, Sugawara S, Miyajima M, Ogawa S, Matsui M, Takayama K, Nagai T. Simultaneous optimization of wet granulation process involving factor of drug content dependency on granule size. *Drug Dev Ind Pharm* 1998; 24:1055–1065.
35. Hariharanand M, Mehdizadeh E. The use of mixer torque rheometry to study the effect of formulation variables on the properties of wet granulations. *Drug Dev Ind Pharm* 2002; 28:253–263.
36. Becker D, Rigassi T, Bauer-Brandl A. Effectiveness of binders in wet granulation: a comparison using model formulations of different tableability. *Drug Dev Ind Pharm* 1997; 23:791–808.
37. Suzuki T, Kikuchi H, Yamamura S, Terada K, Yamamoto K. The change in characteristics of microcrystalline cellulose during wet granulation using a high-shear mixer. *J Pharm Pharmacol* 2001; 53:609–616.
38. Habib YS, Abramowitz R, Jerzewski RL, Jain NB, Agharkar SN. Is silicified wet-granulated microcrystalline cellulose better than original wet-granulated microcrystalline cellulose? *Pharm Dev Technol* 1999; 4:431–437.
39. Badawy SI, Menning MM, Gorko MA, Gilbert DL. Effect of process parameters on compressibility of granulation manufactured in a high-shear mixer. *Int J Pharm* 2000; 198:51–61.
40. Oulahna D, Cordier F, Galet L, Dodds JA. Wet granulation: the effect of shear on granule properties. *Powder Technol* 2003; 130:238–246.
41. Bockand TK, Kraas U. Experience with the Diosna mini-granulator and assessment of process scalability. *Eur J Pharm Biopharm* 2001; 52:297–303.
42. Holm P, Schaefer T, Larsen C. End point detection in a wet granulation process. *Pharm Dev Technol* 2001; 6:181–192.
43. Timmins P, Delargy AM, Minchom CM, Howard JR. Influence of some process variables on product properties for a hydrophilic matrix controlled-release tablet. *Eur J Pharm Biopharm* 1992; 38:113–118.
44. Kornchankul W, Hamed E, Parikh NH, Sakr A. Effect of drug proportion and mixing time on the content uniformity of a low-dose drug in a high shear mixer. *Pharmazie* 2002; 57:49–53.
45. Suzuki T, Kikuchi H, Yonemochi E, Terada K, Yamamoto K. Interaction of microcrystalline cellulose and water in granules prepared by a high-shear mixer. *Chem Pharm Bull (Tokyo)* 2001; 49:373–378.
46. Schaefer T, Holm P, Kristensen HG. Comparison between granule growth in a horizontal and a vertical high speed mixer. II. Granulation of lactose. *Arch Pharm Chem, Scientific Edition* 1986; 14:17–29.
47. Holm P. Effect of impeller and chopper design on granulation in a high speed mixer. *Drug Dev Ind Pharm* 1987; 13:1675–1701.



48. Faure A, Grimsey IM, Rowe RC, York P, Cliff MJ. Process control in a high shear mixer-granulator using wet mass consistency: the effect of formulation variables. *J Pharm Sci* 1999; 88:191–195.
49. Holm P, Schaefer T, Kristensen HG. Granulation in high-speed mixers. Part VI. Effects of process conditions on power consumption and granule growth. *Powder Technol* 1985; 43:225–233.
50. Corvari V, Fry WC, Seibert WL, Augsburg L. Instrumentation of a high-shear mixer: evaluation and comparison of a new capacitive sensor, a watt meter, and a strain-gage torque sensor for wet granulation monitoring. *Pharm Res* 1992; 9:1525–1533.
51. Kopcha M, Roland E, Bubb G, Vadino WA. Monitoring the granulation process in a high shear mixer/granulator: an evaluation of three approaches to instrumentation. *Drug Dev Ind Pharm* 1992; 18:1945–1968.
52. Holm P, Schaefer T, Kristensen HG. Granulation in high-speed mixers. Part V. Power consumption and temperature changes during granulation. *Powder Technol* 1985; 43:213–223.
53. Leuenberger H. Granulation, new techniques. *Pharm Acta Helv* 1982; 57:72–82.
54. Werani J. Production experience with end point control. *Acta Pharm Suecica* 1988; 25:247–266.
55. Laicher A, Profitlich T, Schwitzer K, Ahlert D. A modified signal analysis system for end-point control during granulation. *Eur J Pharm Sci* 1997; 5:7–14.
56. Kornchankul W, Parikh NH, Sakr A. Correlation between wet granulation kinetic parameters and tablet characteristics. *Drugs Made Germany* 2001; 44:78–87.
57. Achanta AS, Adusumilli PS, James KW. Endpoint determination and its relevance to physicochemical characteristics of solid dosage forms. *Drug Dev Ind Pharm* 1997; 23: 539–546.
58. Whitaker M, Baker GR, Westrup J, Goulding PA, Rudd DR, Belchamber RM, Collins MP. Application of acoustic emission to the monitoring and end point determination of a high shear granulation process. *Int J Pharm* 2000; 205:79–92.
59. Watano S, Numa E, Miyanami K, Osako Y. On-line monitoring of granule growth in high shear granulation by an image processing system. *Chem Pharm Bull (Tokyo)* 2000; 48:1154–1159.
60. Watano S, Numa T, Miyanami K, Osako Y. A fuzzy control system of high shear granulation using image processing. *Powder Technol* 2001; 115:124–130.
61. Bouckaert S, Massart DL, Massart B, Remon JP. Optimization of a granulation procedure for a hydrophilic matrix tablet using experimental design. *Drug Dev Ind Pharm* 1996; 22:321–327.
62. Vojnovic D, Selenati P, Rubessa F, Moneghini M, Zanchetta A. Wet granulation in a small scale high shear mixer. *Drug Dev Ind Pharm* 1992; 18:961–972.
63. Vojnovic D, Moneghini M, Rubessa F, Zanchetta A. Simultaneous optimization of several response variables in a granulation process. *Drug Dev Ind Pharm* 1993; 19:1479–1496.
64. Vojnovic D, Moneghini M, Rubessa F. Optimization of granulates in a high shear mixer by mixture design. *Drug Dev Ind Pharm* 1994; 20:1035–1047.
65. Vojnovic D, Moneghini M, Chicco D. Nonclassical experimental design applied in the optimization of a placebo granulate formulation in high-shear mixer. *Drug Dev Ind Pharm* 1996; 22:997–1004.
66. Horsthuis GJB, van Laarhoven JAH, van Rooij RCBM, Vromans H. Studies on upscaling parameters of the Gral high-shear granulation process. *Int J Pharm* 1993; 92:143–150.
67. Ameye D, Keleb E, Vervaeet C, Remon Jean P, Adams E, Massart Desire L. Scaling-up of a lactose wet granulation process in Mi-Pro high shear mixers. *Eur J Pharm Sci* 2002; 17:247–251.
68. Iskandarani B, Shiromani PK, Clair JH. Scale-up feasibility in high-shear mixers: determination through statistical procedures. *Drug Dev Ind Pharm* 2001; 27:651–657.

69. Leuenberger H. Scale-up of granulation processes with reference to process monitoring. *Acta Pharm Technol* 1983; 29:274–280.
70. Zlokarnik M. Problems in the application of dimensional analysis and scale-up of mixing operations. *Chem Eng Sci* 1998; 53:3023–3030.
71. Lord R. The principle of similitude. *Nature* 1915; 95:66–68.
72. Faure A, Grimsey IM, Rowe RC, York P, Cliff MJ. A methodology for the optimization of wet granulation in a model planetary mixer. *Pharm Dev Technol* 1998; 3:413–422.
73. Buckingham E. On physically similar systems; Illustrations of the use of dimensional equations. *Phys Rev NY* 1914; 4:345–376.
74. Faure A, Grimsey IM, Rowe RC, York P, Cliff MJ. Applicability of a scale-up methodology for wet granulation processes in Collette Gral high shear mixer-granulators. *Eur J Pharm Sci* 1999; 8:85–93.
75. Siroisand PJ, Craig GD. Scale-up of a high-shear granulation process using a normalized impeller work parameter. *Pharm Dev Technol* 2000; 5:365–374.
76. Kristensen HG. Particle agglomeration in high shear mixers. *Powder Technol* 1996; 88:197–202.
77. Rekhi GS, Caricofe RB, Parikh DM, Augsburgers LL. A new approach to scale-up of high shear granulation process. *Pharm Technol* 1996; 20:58–67.
78. Ogawa S, Kamijima T, Miyamoto Y, Miyajima M, Sato H, Takayama K, Nagai T. A new attempt to solve the scale-up problem for granulation using response surface methodology. *J Pharm Sci* 1994; 83:439–443.

# 8

## Low-Shear Granulation

**Tom Chirkot**

*Patterson-Kelley Co., East Stroudsburg, Pennsylvania, U.S.A.*

**Cecil Propst**

*SPI Pharma, Norton Shores, Michigan, U.S.A.*

### 1. INTRODUCTION

Shearing of the powder bed occurs in many granulators. The low-shear granulators included in this chapter are granulators that, for reasons of agitator speed, sweep volume, or bed pressures, generate less shear than granulators discussed in other chapters such as extruders or the high-shear mechanical granulators. Also considered to be low shear, but covered in other chapters, are fluid bed granulators.

#### 1.1. Comparison of Granulators

Comparing final granule characteristics in fluid bed, low-shear, and high-shear applications is problematic because it is often difficult for the same formulation to be successfully processed in each piece of equipment. However, some broad conclusions may be drawn. Two of the characteristics most frequently reported are bulk density and particle size; therefore, a comparison will be shown for these characteristics. These granulators may accomplish the same unit operation but the final product outcome may be quite different. The differences are a result of varied process requirements in each granulator. The process of wet granulation involves several steps including blending, liquid binder addition, and wet massing or distribution of the liquid. After charging the powder to the mixer, a blending step is required to achieve a homogenous blend. The time required to achieve the blend depends on the amount of movement characteristic of the unit and the size of the unit. Also, the degree of homogeneity differs from one type of mixer class to the next. In some classes of mixers, one can easily overblend and segregate components of the mix.

The binder solution addition step follows the blending step. The selection of the type of binder and quantity depends on the type of mixer selected for the wet granulation. Nough (1) studied a sulfadiazine formulation using several different binders. He worked in both a fluid bed unit and a conventional wet massing–screening method. When using 5% gelatin as a binder, he noted a 0.968 mm average granule size in wet massing and 0.574 mm in the fluid bed. For acacia as binder at the 5%

level, the values were 0.90 mm for wet massing and 0.605 mm for the fluid bed. For a polyvinylpyrrolidone (PVP) binder at the 5% level, the wet massing produced 0.962 mm granule size vs. 0.247 mm for the fluid bed. Surprisingly, the difference between the methods did not transfer to bulk density results. Both the acacia and the PVP formulations had similar bulk densities in both methods. The gelatin did show a difference, yielding 0.476 g/mL for the wet massing and 0.294 g/mL for the fluid bed. Gore et al. (2) made a comparison among a fluid bed granulator, a planetary mixer, and a high-shear granulator. They found that the granule yield between 20 and 100 mesh was 97.7% in the fluid bed, 53.3% in the planetary mixer, and 71.8% in the high-shear granulator. The respective bulk densities were 0.39, 0.66, and 0.71 g/mL. For comparison, in a low-shear tumble granulator, Scarpone et al. (3) found 84% yield between 20 and 100 mesh in a 0.05 m<sup>3</sup> (2 ft<sup>3</sup>) vessel and 50.7% yield in a 2.83 m<sup>3</sup> (100 ft<sup>3</sup>) vessel. Density measurements averaged 0.486 g/mL for the two trials of a cardiovascular drug formulation in the smaller vessel. Sheskey and Williams (4) studied a niacinamide formulation in both low- and high-shear granulators and concluded that the resulting apparent densities were nearly identical in both cases. In general, the bulk density values produced in low-shear tumbling granulators are intermediate in value between those of a fluid bed and of a high-shear granulator.

Similar conclusions may be drawn about granule morphology as lower-shear granulators produce fluffier, more porous granules than do high-shear granulators. A final note related to morphology: If the low-shear tumbling granulator has a rotating shell, some rounding of granules may be expected as the material flows through the angle of repose.

## 1.2. Binder Issues

Because of improved liquid distribution early in the granulation process, some high-shear granulators require 60–80% of the liquid needed in a low-shear mixer. Liquid requirement for an antacid granulation made in a high-shear horizontal mixer was 4.5% of the total batch, whereas 7% liquid was required for a low-shear planetary mixer. Some of the low-shear granulators such as the sigma mixer densify granules. The liquid requirement for the sigma mixer is slightly reduced at 6% for the same antacid. Some studies indicate that dissolving a solid binder and adding it to the dry mix vs. adding the solid binder to the dry mix and then wetting increases dried granule hardness (5).

The final stage of the wet granulation process is the liquid distribution or the wet massing. This step can be compared with a kneading step during which the voids between granules are compressed and the granules are thereby densified. The final density of the granules, therefore, is dependent on the amount of shearing available in the unit. Because the shear is introduced in the mixing process by mechanical means by moving impellers or blades, these low-shear mixers cannot compress the voids between the granules solely by mechanical means and thus require more binder solution to form granules of some integrity.

The combination of less mechanical shear and lower bed pressure allows for a thicker binder deposit, especially when the binder is poured into the granulation unit instead of sprayed. This thicker film often dries to a more effectively spreadable film during the compression of these granules to form tablets. This increased plasticity is especially true at the lower compression forces (Fig. 1). The tablets also have

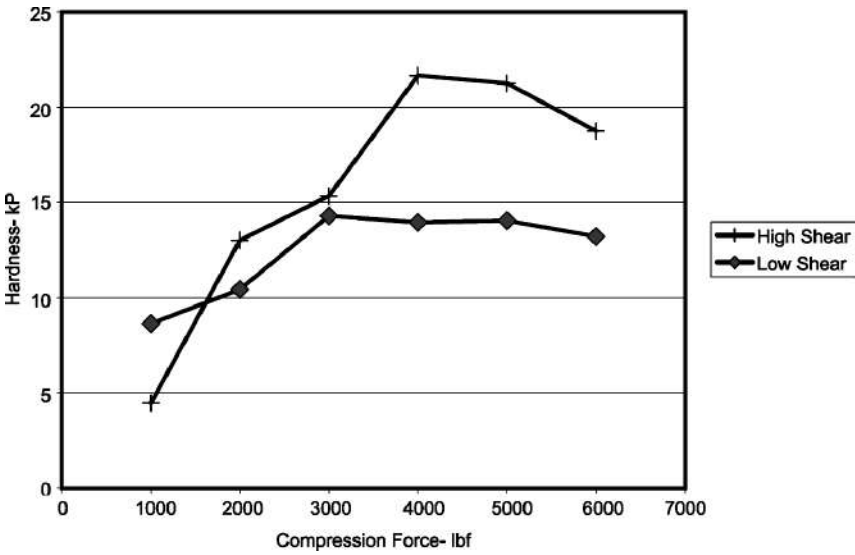


Figure 1 Hardness vs. compression forces.

a much lower friability (Fig. 2). The improved friability can be over a much broader range of compression forces.

## 2. MECHANICAL AGITATOR GRANULATORS

The machine classes to be considered under mechanical agitator granulators are; (1) ribbon or paddle blender; (2) planetary mixers; (3) orbiting screw mixers; and (4) sigma blade mixers.

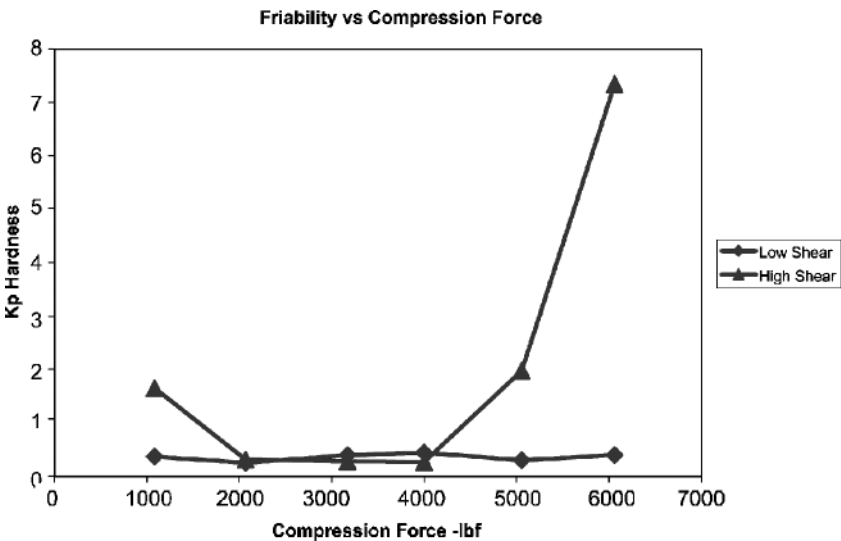


Figure 2 Friability vs. compression forces.

## 2.1. Ribbon or Paddle Blenders

The ribbon blender-type mixer (Fig. 3) is very popular as a dry mixer. However, if small amounts of liquid are added or if a dry paste is formulated for the machine, the ribbon blender can serve as a very reliable granulator (5). Most ribbon blenders are not made to withstand the shaft torque required for manufacturing granules. One should ensure that the granulator shaft is strong enough before granulating in a ribbon blender designed to dry mix.

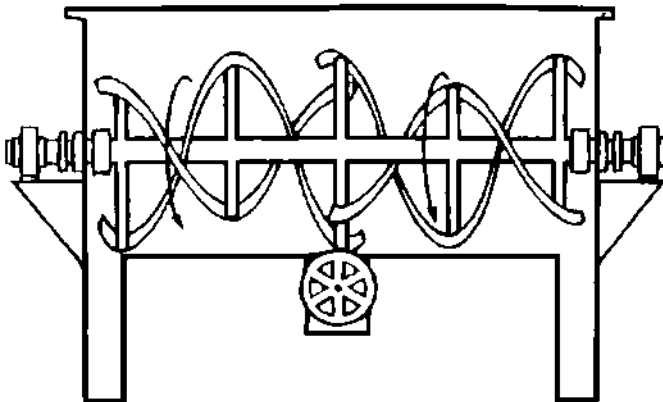
Zoglio et al. (5) studied several kneading times in a chopper ribbon blender and discovered an optimum range of kneading times for providing the best granule mechanical properties. A kneading time that is too long densifies the granules. This increases moisture exposure and particle size and reduces porosity. The tendency of the material to stick to the side wall is pronounced in the ribbon blender.

Paddles instead of ribbons decrease sticking problems and the torque required. Paddle blenders as batch granulators can handle wetter paste. These paddle blenders are occasionally used as continuous granulators and have both lower torque and more applications than a continuous ribbon blender. The movement of the paste helps remove material from the paddles. Formulation of a nontacky paste is aided by using a substance such as microcrystalline cellulose that helps absorb the excess moisture from the mix, yet is plastic and nonsticky.

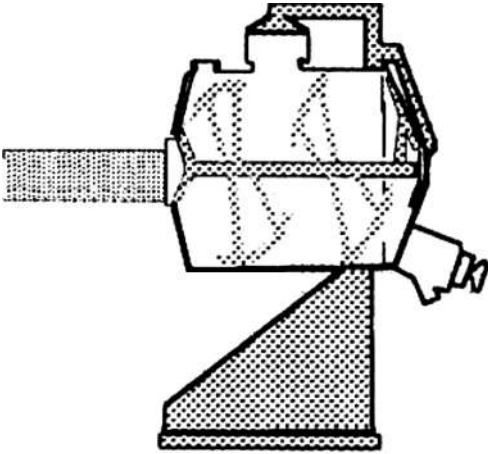
Two very popular ribbon or paddle blenders used as granulators are the topogranulator and the turbulizer.

The topogranulator (Fig. 4) is a batch-style ribbon blender with the ability to either compress or mechanically fluidize the granulation. Compression while slightly wet increases the overall influence of the liquid on the particle size of the granulation. At the other extreme, fluidization reduces density if used during the granule growth phase or speeds drying. The topogranulator is also a vacuum dryer.

The topogranulator is used extensively to make effervescent products by liquid addition under vacuum or by the Murry fusion method (6). Murry's method uses liberated moisture from the acid in the mix (i.e., hydrous citric acid) to start the acid–base reaction, which generates more water. Thus, granulating of the sodium bicarbonate–citric acid mixture can be accomplished. The water produced must be removed quickly to reproducibly stop the reaction. The topogranulator, because of its ability to compress the particles into the binding moisture, makes a larger, denser



**Figure 3** Ribbon blender.



**Figure 4** Topogranulator.

granulation with lower moisture content. Also, mechanical fluidization and vacuum drying removes the water from the reaction more quickly, making the process more reproducible.

Granulation in vacuum removes entrapped air from the particle surface. Liquid addition into the vacuum provides immediate wetting and also begins the drying process. This granulation in vacuum allows the manufacturing of a calcium carbonate-based effervescence with rapid reactivity (7).

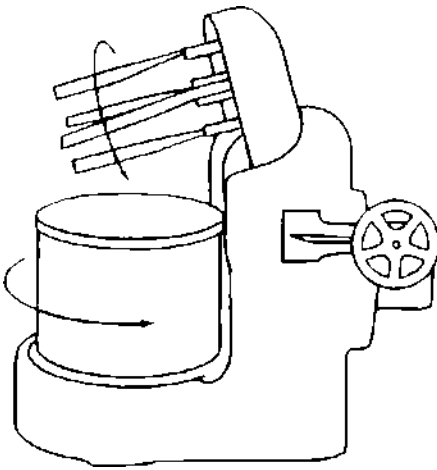
The turbulizer is a continuous paddle granulator. By using continuous powder feeders and liquid metering pumps, the unit produces large quantities of product per hour in a very small space. The unit provides adjustable mixing, shear, and impact action based on the revolutions per minute (rpm) of the shaft and the angle of the impact blade. The paddle adjustments also vary the retention time. This machine has a very low silhouette. Paddles are easily accessible for cleaning and inspection either through a clam shell- or drop door shell-opening side wall. The unit is jacketed for material temperature control.

Another continuous paddle granulator made by Teledyne Readco has been studied by Ghali et al. (8). The unit is adjustable to produce either low- or high-shearing action. The amount of energy induced by the rotating shaft can be selected by using various types of pins. A rounded granule results from the action of the pin tip speed and some rolling of the granulation against the fixed vessel wall.

## 2.2. Planetary Mixers

The planetary motion of these granulators is created by rotating the agitator off an assembly in a direction opposite that of the rotation of the agitator assembly as it moves around the bowl. The planetary mixers (Fig. 5) are represented by many commercial names including Hobart, Kitchen Aide, Pony, and AMF Glen granulators. All of these mixers have the same basic makeup, which includes: (a) planetary motion, (b) removable bowl, and (c) top-drive agitators.

These mixers tend to be better at mixing dry powders in a horizontal plane than the vertical. Lack of vertical mixing may require the materials to be dumped and returned to the bowl to obtain an acceptable dry mix. Reduced vertical mixing



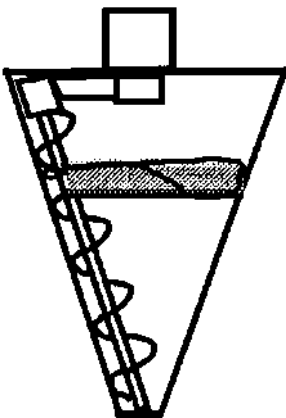
**Figure 5** Planetary mixer.

is much less a problem in the wet-mix phase, because the materials adhere to the agitator and move in groups without vertical stratification.

Remon and Schwartz, working with microcrystalline cellulose and lactose mixtures in a planetary mixer, saw decreased friability of the granule with increasing massing time (9). This increased massing time improves binder distribution and mechanical strength. Ghanta et al. demonstrated the mechanism of granule growth in a Hobart mixer (10).

### 2.3. Orbiting Screw Granulators

The orbiting screw granulator (Fig. 6) is also used mainly for dry mixing. However, the unit has been fitted with the nozzle through the center agitator to add liquids to dry powders (11). Also, a jacket can provide both heating and cooling. A sintered metal plate can allow entry of compressed air through the skin of the mixer or can exhaust moisture to obtain drying. All of these added features, along with a



**Figure 6** Orbiting screw mixer.



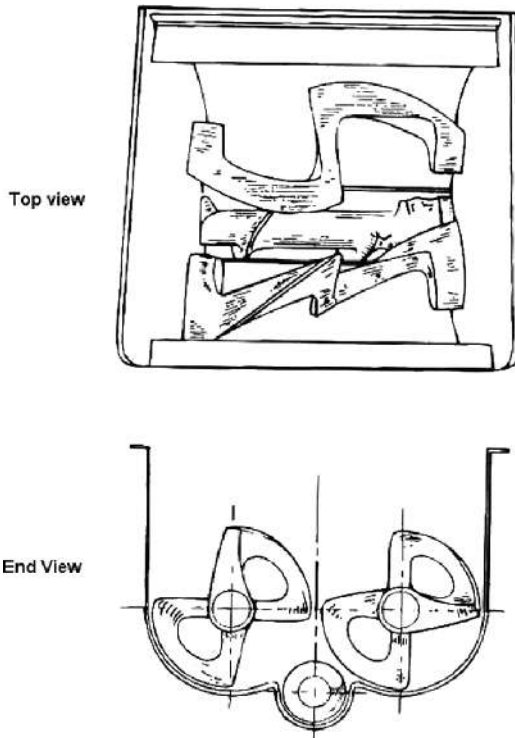
chopper in the side wall, allow this blender to be an effective granulator for powders, slurries, suspensions, and paste. The unit is a very gentle granulator mixer.

## 2.4. Sigma Blade Mixers

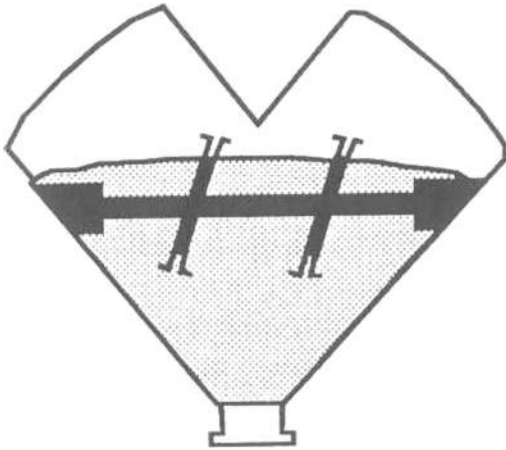
The sigma blade mixer (Fig. 7) is a compressive granulator. Generally, it develops material into a paste- or dough-type consistency. Often the sigma blade mixer is preceded by a dry mixer. The unit generates liquid distribution with pressure during granulating. This creates a uniform granulation with binder matrix and good binder distribution.

## 3. ROTATING SHAPE GRANULATORS

These vessel shapes are usually some derivation of a cylinder, with a double cone and V-shape (Fig. 8) being common examples. Unlike their fluid bed and high-shear counterparts, the machine shells rotate around an axis parallel to the ground. The rotation speed is moderate, and generally falls into a range of 72.2–106.7 m/min (250–350 ft/min) peripheral speed. The rpm value changes as vessel size grows. A laboratory model may rotate at 25–30 rpm, whereas a larger production model may rotate at 4–8 rpm. The peripheral speed remains constant in order to maintain a scale-up relationship among vessel sizes.



**Figure 7** Sigma blade mixer.



**Figure 8** Schematic of the twin-shell blender that allows blending and granulating in a single vessel. (Courtesy of Patterson-Kelley Co., Division of Harsco Corp., East Stroudsburg, PA.)

A second rotating device is located on the same axis of rotation as the shell. This bar or arm may be supported at both ends or may be cantilevered, with support only on a single end. The bar is used to impart substantially more energy into the system than that delivered by the rotating shell. The bar is driven by an additional, larger motor that runs independently of the shell motor. The manufacturer's descriptive names for these bars, such as agitator or intensifier bars, confirm their use. Unlike the gentle rolling action induced by the shell movement, the bar movement has a high-speed nature. This should not be confused with high shear because the bar movement produces mainly a convective motion within the material. Indeed, these machines were originally designed as mixers, with elements of diffusive and convective mixing. Only later in their evolution did they become granulator-dryers.

The increased peripheral speed of the bar is substantial. As a general rule, they operate at 10 times the speed of the shell or about 914.4 mpm (3000 fpm). The bars may also serve as liquid addition devices. The vessels may be jacketed for heating and cooling if there is a necessity for these options during granulation. They are vacuum capable, which makes them ideal candidates as a single-pot processor for mixing, granulating, and drying in the same vessel. Ultimate vessel size for these granulators is constrained by the weight of the agitator bar. The bars have many parts and must be disassembled often for cleaning. Large bars become increasingly unwieldy and difficult to remove from the interior of the vessel.

Ample opportunity exists for fine-tuning a granulation process in these machines. Apparatus variables that can be adjusted are shell speed, bar speed, bar size, and bar design. Process changes can be made in mix time, liquid addition time, bed temperature, internal vessel pressure, and spray droplet size.

Overwhelmingly, these granulator types are used in batch operations. However, a few manufacturers offer continuous granulating systems that emulate the combination of forced and rolling agglomeration found in the batch machines. Besides the issue of validating a continuous process, throughput requirement is usually the influencing criterion when considering a change from batch to continuous operation.

Much of the granulation done in the pharmaceutical industry is by wet massing and, more recently, by fluidized bed (12). Consequently, the literature is rich with articles describing the many variables studied in these machines. On the other hand, the rotating shape granulators originated as mixing devices and a paucity of research articles exist on their usage as granulators. This makes them a fruitful area for future research.

### 3.1. Bar Speed and Energy Input

The combination of agitator bar speed and its accompanying energy input yields a wide influence on the physical properties of the granulated material. Watano et al. (13), using a fluidized bed granulator with an agitator blade, varied the rotation speed of the agitator and observed the effect it had on product density. They were able to derive a predictive equation that yielded the density value when the agitator speed was known. The same group measured shape index—the mean ratio of the short/long diameters—and concluded that as granulation times increased, the shape tended more toward sphericity. The rotating shape granulators vary energy input to the powder bed by changing the agitator speed or extending the running time of the bar after liquid addition has stopped. A common term for the extended bar period is postmix time.

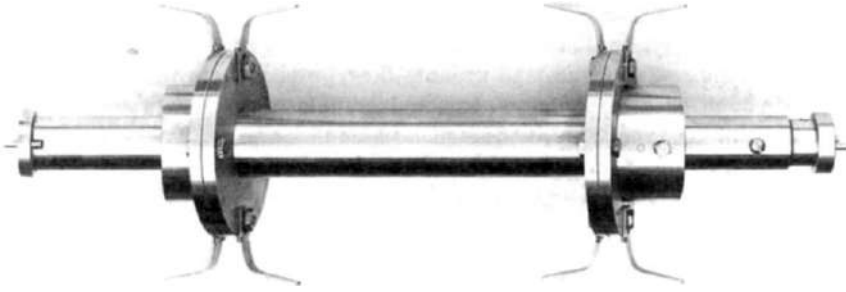
A study of a low-shear granulator, with a formulation consisting of lactose, PVP, and water, that varied the peripheral speed of the bar showed no statistically significant change in granule density despite the substantial change in bar tip speed from 636 to 846 to 1056 mpm (14). The tip speed was statistically influential on the amount of granules found in the yield fraction. The lowest speed produced the best yield indicating that the higher speeds can degrade the formed granules during a postmix phase and thereby cause a reduction in yield. The ultimate lower limit on tip speed is the point where adequate distribution of the binder solution is compromised.

### 3.2. Disk Size and Bar Design

Addition of binder liquid with spray heads is available with rotating shape granulators. The double-cone shape is often used with a dry intensifier bar and spray head combination for granulating. A wide range of bar designs exists for the more typical situation of adding liquid through the bar. Blade or knife design is one variable to consider. The blades extend perpendicularly from the disk circumference and then bend 90° in a shape often called a “dog-eared” design (Fig. 9).

The blade shape is critical for the liquid addition method. As the blades rotate, they carve out a toroidal void volume in the flowing powder bed. The liquid exiting the disk coats the interior of the torus. Proper vessel loading ensures that no liquid impinges on the wall of the vessel.

The action of the blades is quite vigorous and may cause a problem with very friable materials. A modification to the bar that removes the blades and recesses all nuts and bolts can be used to granulate these fragile materials. Further fine-tuning of the spray pattern can be accomplished with changes in the positioning of liquid evacuation spacing on the disk circumference. A straight pattern creates droplet flow orthogonal to the axis of rotation, which allows only a small area of the interior torus to be coated. An angled pattern creates a substantially wider spray effect, with more efficient droplet distribution.



**Figure 9** Intensifier bar for the twin-shell blender/granulator showing a “dog-eared” design. (Courtesy of Patterson-Kelley Co., Division of Harsco Corp., East Stroudsburg, PA.)

Disk diameter is critical. A large-diameter disk imparts more energy as torque is a function of diameter. The larger diameter offers more circumference for liquid to be evacuated and carves out additional void volume in the material. The sweep volume of the disks is considered a major factor in properly scaling up a granulator (15).

### 3.3. Liquid Addition Rate

Particle motion is so complex when granulating that it becomes difficult to determine the optimum rate of liquid addition. Stamm and Paris (16) studied rates of 5, 10, and 20 mL/min in a fixed shell, helicoidal mixer with vertical bar, and determined that the best results occurred at the slowest rate.

Cliff (17), working in a high-shear granulator, found that a long binder addition time was needed to prevent overdensification. Lipps and Sakr (18), using a top-spray, fluidized bed granulator, related geometric mean granule size, specific surface area, and granule flow properties to the binder flow rate.

In rotating shape granulators, the main energy-imparting function and the liquid distribution function are encompassed within the agitator bar, yielding a highly efficient system. Liquid is literally ripped into droplets by the peripheral speed of the bar. Tumbling action ensures that fresh material replaces the wet material during each shell revolution (19). A wide range of liquid addition rates is permissible. The lowest rate is undefined and may involve a slow dropwise addition to the bar. The highest rate is limited to the point when the liquid rate reduces the droplet making efficiency of the bar and results in liquid being forced out in a sheet-like pattern to the powder bed.

When one extends the liquid addition period, the bar continues to abrade the granules. Favorably, any particles that have been fractured can be rewetted and the fracture surface can easily bind to another particle. This mechanism tends to hold down the oversized fraction without the expected increase in the undersized fraction.

Extremely rapid liquid addition overwhelms the blending capability of the system. Many particles simply do not have enough time to become associated with the droplets, whereas others become overwet due to the concentrated onrush of liquid. An additional consequence of high liquid addition rate is that liquid may have difficulty releasing from the bar. A back pressure situation develops that may impede liquid flow in the feed tube and ultimately cause it to reverse its flow. High enough back pressure can induce a spring-loaded bar to jump from its moorings and damage

the interior of the machine. Because the rotating shape granulators are often heat-jacketed, the potential exists for them to provide a partially or fully coated, hard granule.

Use of the dissolved solids binder addition method through an agitator bar could be problematic. Any undissolved solids may clog the liquid evacuation spacing on the disk. Also, binder solutions with a viscosity much beyond 300–500 cP may not atomize readily when released from the disk.

### 3.4. Droplet Size

Droplet size is a very important variable in fluidized bed granulation. Droplet size is unimportant in high-shear granulators because the energy exists to readily distribute and redistribute the liquid. Liquid addition in the rotating shape granulators is unique, for the droplets are released from the fluidizing device or agitator bar. An analogous situation in a high-shear application would mean that liquid was being added through the impeller or chopper.

The liquid in a rotating shape granulator is fed through a tube and exits in the interior of the bar through a distribution slot. A pump can be used for metering the flow, or gravity flow may be sufficient, if desired. The speed of rotation of the bar actually induces an area of lower pressure within the bar to draw in the liquid. The liquid exits the agitator bar through openings on the circumference of the rotating disk. Openings can be adjusted by placement of spacers that vary in thickness. A droplet diameter cannot exceed this thickness value, although smaller droplets may be present. Typical spacer openings are 0.025 cm (0.010 in.) with common adjustment to 0.0125 cm (0.005 in.) and 0.05 cm (0.020 in.), depending on the viscosity of the liquid.

Many granulation methods deliver the liquid at some pressure through a spray head. With liquid addition through the bar, only enough pressure is needed to overcome line loss. Undue pressure is actually counterproductive. The atomization is influenced by pressure and the liquid exiting the disks under high pressure tends to be sheet-like rather than easily distributed droplets.

Droplet size in a fluid bed has been measured by capturing droplets on a slide covered with viscous oil. The size has been determined to be in the 20–100  $\mu\text{m}$  range (20). Less delicate techniques in the rotating shape granulators have shown droplet sizes of about 250  $\mu\text{m}$ . Agland and Iverson provide an experimental study showing the relation of liquid droplet size to granule characteristics such as size and penetration of liquid (21).

### 3.5. Vessel Loading

A negative factor for rotating tumble granulators with high-speed internal bars is the tight constraint for fill level. The fill level is usually about 50–65% of the total volume, and the powder level must have some contact with the bar. Overloading the vessel impedes the mixing action.

Underloading causes material to flow beneath the bar during vessel rotation, resulting in liquid spraying on the interior wall. This spray-through can be a factor in material sticking during a drying step.

Even careful loading of the machine with the dry powder may not be sufficient to preclude spraying through to the walls. If substantial densification occurs during early liquid addition, the load may drop enough during the final stages of liquid

addition for liquid to find its way to the shell wall. The effective working volume fill level can be increased if the tip-to-tip blade diameter is extended.

### 3.6. Low Shear Single Pot Processing

The rotating shape granulators offer fine potential for single-pot processing (Fig. 10). Their original design as mixers ensures even minor ingredients are well-distributed in the dry mix phase prior to granulation.

After granulation, the heated shell and vacuum capability are used for gentle tumble drying and collection of condensed vapors. The bar can then be used to provide a measure of dry sizing, followed by lubricant addition, and tumble blending.

### 3.7. Continuous Granulation

Although batch granulation is commonly used, there are some examples of low-shear continuous granulation. A true adaptation of the batch, rotating shape granulators is the Patterson-Kelley Zig Zag mixer (Figs. 11 and 12). This vessel consists of a high-speed mixing chamber connected to a series of three V-shaped tumble blenders. The principles of liquid addition and disk speeds covered earlier are equally applicable to the Zig Zag.

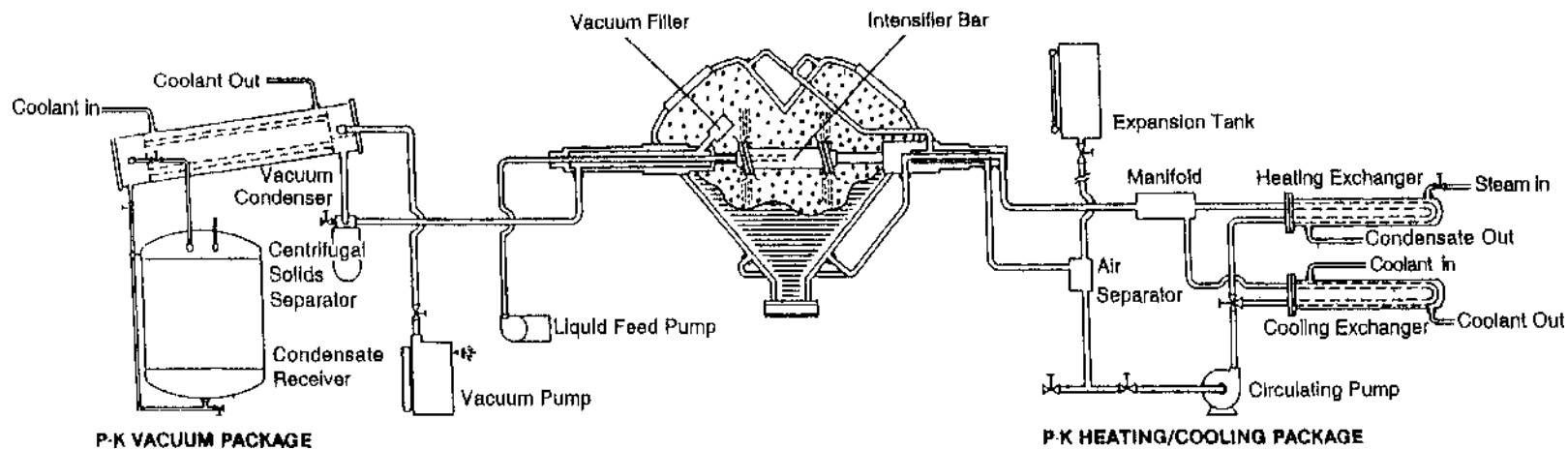
The typical hold-up volume is half of the total volume of the vessel. The hold-up volume can be adjusted somewhat by raising or lowering the discharge end a few degrees from the horizontal. Residence times are in the 3–5 min range for granulation applications. Two types of granulation mechanisms occur in this machine. When the material is in the high-speed mixing chamber, the liquid droplets contact the powder in a manner similar to that of batch units. As the wet material travels into the tumbling section, rolling agglomeration occurs. The tumbling section splits its load in half on each revolution, allowing half the material to proceed forward while the other half recycles to the rear. This action tends to smooth out any inconsistencies.

Scale-up to larger Zig-Zag units is based on constant residence times. Therefore, even in the very largest models, a residence time of 3–5 min can be expected. The largest models are capable of producing 30,000 kg/hr.

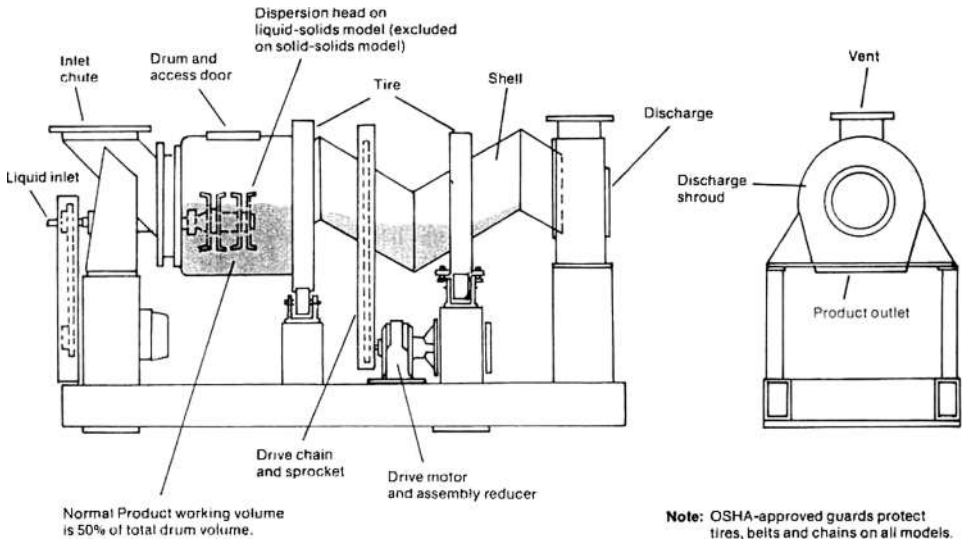
## 4. SCALE-UP

Often, the most difficult part of implementing a granulation process is the scale-up step. The many variables involved and the poorly understood relations among the variables often places scale-up in the realm of trial and error. Hancock et al. (22), using a fixed bowl mixer with meshing blades, linked a torque arm to a dynamometer to monitor the process. The amplitude of oscillation (torque range) and the mean torque increase from baseline were the items recorded. Torque showed a relation for the force required to shear the wet mass and provided an output for determining the wet mass strength. Integrating the torque-time curve yields the total energy into the system for a particular time period. Hancock's group defined the term, cumulative energy of mixing, and postulated its use as a means of scaling up.

Vojnovic et al. (23) determined that peripheral speed of the impeller in a vertical high-shear mixer was an important factor and adjusted this speed as a function



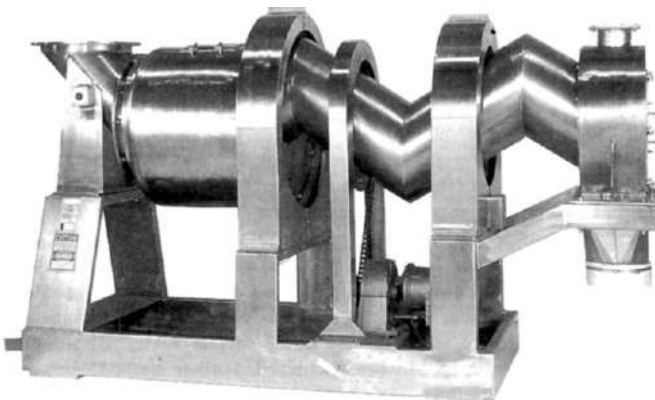
**Figure 10** Schematic diagram of Patterson-Kelley Solids Processor. (Courtesy of Patterson-Kelley Co., Division of Harsco Corp., East Stroudsburg, PA.)



**Figure 11** Schematic of a Zig-Zag, which is an example of a continuous granulating machine. (Courtesy of Patterson-Kelley Co., Division of Harsco Corp., East Stroudsburg, PA.)

of the diameter of the larger mixer. They found this to be an adequate scale-up method despite a geometric dissimilarity in the two mixers studied.

Further work on the rheologic character of the wet mass and the effect on scale-up was performed by York in a high-shear mixer–granulator (24). It was theorized that the power number–Reynolds number relationship used in the scale-up of fluid mixing impeller systems could be applicable to the granulation mechanism in high-shear mixer. To analyze the relationship, appropriate machine information needed to be measured, as did the density and viscosity of the wet mass. Mixer torque rheometry was used to determine wet mass viscosity, and yielded a pseudo-Reynolds number with the units of torque. It is interesting to note that some unit operations textbooks show similar logic in developing scale-up equations for dry powder mixing (25).



**Figure 12** Zig-Zag mixer–agglomerator. (Courtesy of Patterson-Kelley Co., Division of Harsco Corp., East Stroudsburg, PA.)



Scaling up the process in a low-shear granulator is a daunting task. Scale-up equations are usually proprietary to the mixer manufacturers and little is written about them in the literature. The equations have a sound basis in science but are ameliorated by constants and factors that take into consideration empirical feedback and intuition concerning the machine function.

Most commonly, an energy/volume ratio is established in the smaller vessel. This ratio is emulated in the larger vessel, with appropriate consideration for the added mass and the larger motor, to yield an estimated scale-up time.

Scarpone et al. (3) studied a change in granulation technology from a high-shear mixing bowl to a V-shaped granulator. Developmental work was done in a 0.056 m<sup>3</sup> (2 ft<sup>3</sup>) vessel and the ultimate production in a 2.83 m<sup>3</sup> (100 ft<sup>3</sup>) vessel. Scale-up based on the manufacturer's recommendation was not exact and required some fine-tuning before the process was established in the larger vessel.

This study provides a detailed look at some of the hazards encountered in scaling up. The initial trial in the 2.83 m<sup>3</sup> (100 ft<sup>3</sup>) production vessel failed to provide an adequate granulation. The main reason for the failure was that the scale-up trial lacked the active ingredient and contained only excipient. This highlights the necessity of maintaining as much constancy as possible, both with formulation and process variables. Additional tests with the active ingredient were much closer to the results gained in the smaller vessel. By the third trial, a successful scale-up had been achieved. Further studies were conducted to evaluate the influence of changes in the physical characteristics of the active ingredient. For example, density changes had an influence on the binder liquid needed. The researchers were able to use their knowledge from the scale-up to achieve another scale-up on a different product.

M. Uliveri, M. Eli, and R. Bianchini (unpublished data) also attempted a scale-up in a V-shaped granulator. The laboratory vessel was a 0.056 m<sup>3</sup> (2 ft<sup>3</sup>) model and the scale-up vessel was a 0.283 m<sup>3</sup> (10 ft<sup>3</sup>). They found it was necessary to increase the batch size 1.2 times over the direct 10:2 ratio, that the total liquid was 82% of direct scale-up, and the granules were slightly larger in the scale-up vessel.

Another scale-up attempt in a V-shaped granulator involved a 2 and 57 L vessel (15). The author used a cumulative torque to mass ratio as a means of relating the process in both vessels. A separate, individual method is also provided for scaling-up the liquid addition time.

Suitably, an article by Ennis et al. (26) highlights the fact that understanding granulation scale-up is a needed growth area for further research.

## 5. END-POINT DETERMINATION AND CONTROL

The rapidity by which granulation proceeds makes end-point determination a difficult problem. Growth behavior is nonlinear, preventing easy solutions to the differential equations describing the process (27). Watano et al. (13) used an infrared moisture sensor to continuously monitor moisture through a PID feedback loop. The current was used to control the liquid addition pump until a suitable size was achieved. Leuenberger et al. (28) plotted the power consumption curve in a planetary mixer and observed five distinct phases that were dependent on the amount of liquid added. Zoglio et al. (5), working in a ribbon blender, postulated a potential end-point determination using specific pore area. Ghanta et al. (10) installed a slip ring torque sensor between the Hobart mixer agitator and motor and observed five

phases in the torque profile. This process was repeatable and could be considered for granulation end point in this type of mixer. Another method uses effusivity to determine the amount of moisture in the granule for end-point determination (29).

## 6. CONCLUSIONS

Low-shear granulators offer a middle ground solution for many of the problems formulators may encounter. Much denser granules may be produced in these vessels, compared with a fluid bed device, yet the energy expended is not as great as that found in a high-shear machine. Many of the low-shear granulators are extremely adaptable devices capable of mixing the formulation constituents before granulating, and some even dry the materials after granulation is complete. Ample opportunity is available in these granulators for adjustments: energy input may be altered with variable speed drives; droplet size may be changed through judicious selection of spray heads; and various agitating bar designs may be selected. As with many other granulators, scale-up and end-point detection remain poorly defined. A trial and error procedure is often the only method to determine end point and scale-up.

## REFERENCES

1. Nouh ATI. The effect of variations in concentration and type of binder on the physical characteristics of sulfadiazine tablets and granulations prepared by wet and fluidized-bed granulation method. *Pharm Ind* 1986; 48(6):670.
2. Gore AY, McFarland DW, Batuyios NH. Fluid-bed granulation: factors affecting the process in a laboratory development and production scale-up. *Pharm Technol* 1985:114–122.
3. Scarpone AJ, Dalvi UG, Delorimier AE. Preparing tablet granulations in a 100 cu ft solids processor. *Pharm Technol* 1986; 10:44.
4. Sheskey PJ, Williams DM. Comparison of low-shear and high-shear wet granulation techniques and the influence of percent water addition in the preparation of a controlled-release matrix tablet containing HPMC and a high-dose, highly water-soluble drug. *Pharm Technol* 1996:80–90.
5. Zoglio MA, Huber HE, Koehne G, Chan PL, Carstensen JT. Physical aspects of wet granulation II: factors involved in prolonged and excessive mixing. *J Pharm Sci* 1976; 65:1205.
6. Murry R. *J Pharm Sci* 1968; 57:1776–1779.
7. Gergely et al. Effervescent system for effervescent tablets and effervescent granules. US Patent 5888544, March 30, 1999.
8. Ghali S, Contractor AM, Mankad AD, O'Connor RE, Schwartz JB, Auslander DE, Grim WM. A high-speed mixer for continuous wet granulation. *Pharm Technol* 1990; 14:60.
9. Remon JP, Schwartz JB. Effect of raw materials and processing on the quality of granules prepared from microcrystalline cellulose-lactose mixtures. *Drug Dev Ind Pharm* 1987; 13:1.
10. Ghanta SR, Srinivas R, Rhodes CT. Use of mixer torque measurements as an aid to optimizing wet granulation process. *Drug Dev Ind Pharm* 1984; 10:305–311.
11. Day JH & Co. News bulletin: monitoring particle density, moisture content, particle size, and process weight. Cincinnati, OH, 1983.
12. Schaefer T. Equipment for wet granulation. *Acta Pharm Suecica* 1988; 25:205.

13. Watano S, Terashita K, Miyanami K. Determination of end-point with a complex granulation applying infrared moisture sensor. *Chem Pharm Bull* 1991; 329:1013.
14. Chirkot TS. Characterization of a pharmaceutical wet granulation process in a V-type granulator. *Pharm Eng* 1999; 19(4).
15. Chirkot TS. Scale-up and endpoint issues of pharmaceutical wet granulation in a V-type low shear granulator. *Drug Dev Ind Pharm* 2002; 28:871.
16. Stamm A, Paris L. Influence of technological factors on the optimal granulation liquid requirement measured by powder consumption. *Drug Dev Ind* 1985; 11:333.
17. Cliff MJ. Granulation end point and automated process control of mixer-granulators: part I. *Pharm Technol* 1990; 14:112.
18. Lipps D, Sakr AM. Characterization of wet granulation process parameters using response surface methodology. 1. Top-spray fluidized bed. *J Pharm Sci* 1994; 83:937.
19. Fischer JJ. Liquid-solids blending. *Chem Eng* 1962; 3(Feb 5).
20. Lindberg NO, Jonsson C. The granulation of lactose and starch in a recording high-speed mixer, Diosna P25. *Drug Dev Ind Pharm* 1985; 1:387.
21. Agland S, Iverson S. The impact of liquid droplets on powder bed surfaces. CHEMECA '99, Newcastle, Australia, Sep 26–29, 1999:25.
22. Hancock C, York P, Rowe RC, Parker MD. Characterization of wet masses using a mixer torque rheometer: 1. Effect of instrument geometry. *Int J Pharm* 1991; 76:239.
23. Vojnovic D, Moneghini M, Rubessa F, Zanchetta A. Simultaneous optimization of several response variables in a granulation process. *Drug Dev Ind Pharm* 1993; 19:1479.
24. York P. Granulation using mechanical agitation. Proceedings of IFPRI Annual Meeting, Urbana, IL, 1995.
25. McCabe WL, Smith JC, Harriot P. *Unit Operations of Chemical Engineering*. 4th ed. New York: McGraw-Hill, 1985:846.
26. Ennis BJ, Green J, Davies R. The legacy of neglect in the US. *Chem Eng Prog* 1994:32.
27. Oliver R, Ford LJ. The role of agglomeration in chemical and process technology. Proceedings of the Institute for Briquetting and Agglomeration, Orlando, FL, 1987:1–32.
28. Leuenberger H, Bier HP, Sucker HB. The theory of the granulating liquid requirement in the conventional granulation process. *Pharm Technol* 1986; 11:76.
29. Mathis Instruments. *Technical Literature*. Frederickton, NB, Canada: Mathis Instruments, 2003.

# 9

## Batch Fluid Bed Granulation

**Dilip M. Parikh**

*Synthon Pharmaceuticals Inc., Research Triangle Park, North Carolina, U.S.A.*

**Martin Mogavero**

*Niro Pharma Systems, Columbia, Maryland, U.S.A.*

### 1. INTRODUCTION

Fluidization is the unit operation by which fine solids are transformed into a fluid-like state through contact with a gas. At certain gas velocities, the fluid will support the particles, giving them freedom of mobility without entrainment. Such a fluidized bed resembles a vigorously boiling fluid, with solid particles undergoing extremely turbulent motion, which increases with gas velocity. Fluidized bed granulation is a process by which granules are produced in a single piece of equipment by spraying a binder solution on to a fluidized powder bed. This process is sometimes classified as the one-pot system. The fluid bed granulation process has received considerable attention within the pharmaceutical industry; however, other process industries, such as food, agro-chemical, dyestuffs, and other chemical industries, have adopted the fluid bed granulation process to address particle agglomeration, dust containment, and material handling. The fluidization technique, as it is known today, began in 1942, with the work of the Standard Oil Company (now known as Exxon, in the United States) and M.W. Kellogg Company, in an effort to produce the first catalytic cracking plant on a commercial scale (1).

Fluid bed processing of pharmaceuticals was first reported by Wurster, when he used the air suspension technique to coat tablets (2,3). In 1960, he reported on granulating and drying of a pharmaceutical granulation, suitable for the preparation of compressed tablets, using the air suspension technique. In 1964, Scott et al. (4) and Rankell et al. (5) reported on the theory and design considerations of the process, using a fundamental engineering approach and employing mass and thermal energy balances. They expanded this application to the 30 kg-capacity pilot plant model designed for both batch and continuous operation. Process variables, such as airflow rate, process air temperature, and liquid flow rate were studied. Contini and Atasoy (6) later reported the processing details and advantages of the fluid bed process in one continuous step.

Wolf (7) discussed the essential construction features of the various fluid bed components, and Liske and Mobus (8) compared the fluidized bed and traditional

granulation process. The overall results indicated that the material processed by the fluid bed granulator was finer, more free-flowing, and had homogenous granules, which, after compression, produced stronger and faster disintegration of tablets than the materials processed by conventional wet granulation. Reviews by Sherrington and Oliver (9), Pietch (10), and a series published on the topic of “Fluidization in the Pharmaceutical Industry” (11–17) provide an in-depth background on the fundamental aspects of the fluidized bed and other granulation technologies. The fluidized bed was used only for drying the pharmaceutical granulation efficiently in early days, but now it is employed routinely for drying, agglomeration, pelletization, and production of modified-release dosage forms using air suspension coating. Because of this, these units are normally classified as multiprocessor fluid bed units.

The size enlargement of primary particles has been carried out in the pharmaceutical industry in a variety of ways. One of the most common unit operations used in the pharmaceutical industry is fluid bed processing. The batch size increase using fluid bed granulation requires a good understanding of the equipment functionality, theoretical aspect of fluidization, excipient interactions, and most of all identifying the critical variables that affect the process of agglomeration.

This chapter will provide the essential understanding of the fluidization theory, system description that make up the fluid bed processor, and will discuss the critical variables associated with the equipment, the product, and the process.

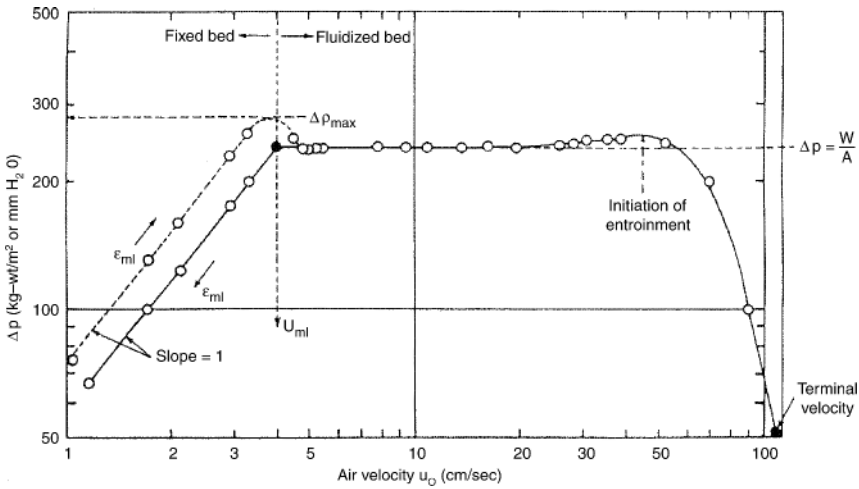
## 2. FLUIDIZATION THEORY

A fluidized bed is a bed of solid particles with a stream of air or gas passing upward through the particles at a rate great enough to set them in motion; this velocity, according to Külling and Simon (18), is higher than the incipient fluidizing velocity, but lower than the entrainment velocity. When the rate of flow of gas increases, the pressure drop across the bed also increases until, at a certain rate of flow, the frictional drag on the particles equals the effective weight of the bed. These conditions, and the velocity of gas corresponding to it, are termed *incipient fluidization* and *incipient velocity*, respectively. The relationship between the air velocity and the pressure drop is as shown in Figure 1 (19).

At low gas velocities the bed of particles is practically a packed bed, and the pressure drop is proportional to the superficial velocity. As the gas velocity is increased, a point is reached at which the bed behavior changes from fixed particles to suspended particles. The superficial velocity required to first suspend the bed particles is known as *minimum fluidization velocity* ( $u_{mf}$ ). The minimum fluidization velocity sets the lower limit of possible operating velocities, and the approximate pressure drop can be used to approximate pumping energy requirements. For the agglomeration process in the fluid bed processor, the air velocity required is normally five to six times the minimum fluidization velocity.

At the incipient point of fluidization, the pressure drop of the bed will be very close to the weight of the particles divided by the cross-sectional area of the bed ( $W/A$ ). For the normal gas fluidized bed, the density of the gas is much less than the density of the solids and the balance of forces can be shown as

$$\Delta P_{mf} = W/A \quad \text{where } W = (1 - \varepsilon_{mf})\rho_p(g/gc)$$



**Figure 1** Relation between the air velocity and pressure drop. (From Ref. 19.)

where  $\Delta P$  = pressure drop,  $\varepsilon_{mf}$  = minimum fluidization void fraction,  $A$  = cross-sectional area,  $W$  = weight of the particles,  $\rho_p$  = density of particles,  $g/g_c$  = ratio of gravitational acceleration and gravitational conversion factor.

The fundamental phenomenon of fluidization was recently studied by researchers (20) using a small-scale fluid bed unit. The purpose of the study was to compare experimental and computational minimum fluidizing velocities ( $u_{mf}$ ) of pharmaceutical materials using miniaturized fluid bed device. Using various materials, researchers found that the experimental method was more capable of describing the fluidizing behavior of pharmaceutical materials than the computational approach. Computational models of fluidization are based on the behavior of various model particles. Computational models do not take into account particle size and shape distributions, cohesion and adhesion of pharmaceutical materials.

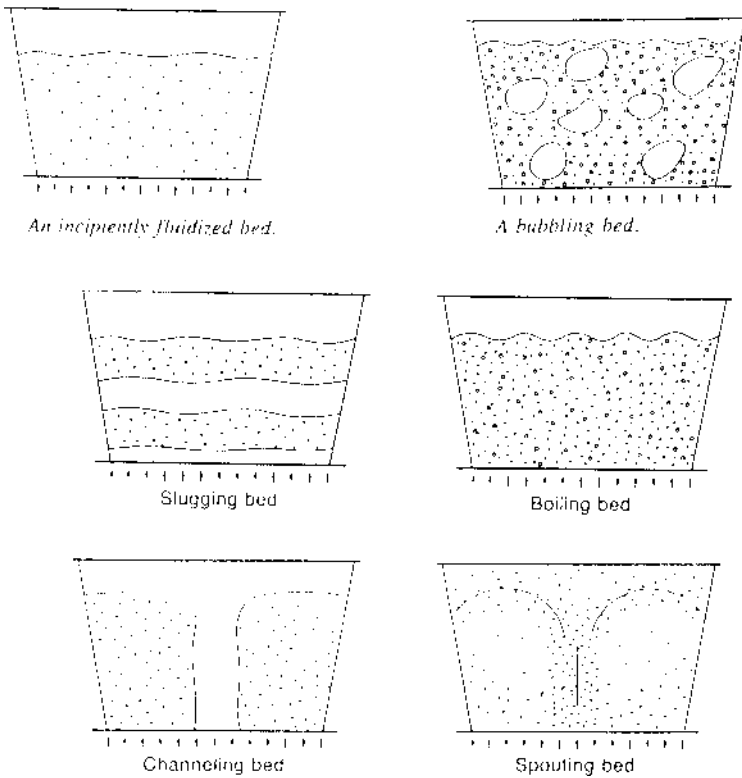
As the velocity of the gas is increased further, the bed continues to expand and its height increases with only a slight increase in the pressure drop. As the velocity of the gas is further increased, the bed continues to expand and its height increases, whereas the concentration of particles per unit volume of the bed decreases. At a certain velocity of the fluidizing medium, known as entrainment velocity, particles are carried over by the gas. This phenomenon is called entrainment. When the volumetric concentration of solid particles is uniform throughout the bed all the time, the fluidization is termed as *particular*. When concentration of solids is not uniform throughout the bed, and if the concentration keeps fluctuating with time, the fluidization is called *aggregative fluidization*.

A *slugging bed* is a fluid bed in which the gas bubbles occupy the entire cross-section of the product container and divide the bed into layers.

A *boiling bed* is a fluid bed, in which the gas bubbles are approximately of the same size as the solid particles.

A *channeling bed* is a fluid bed, in which the gas forms channels in the bed through which most of the air passes.

A *spouting bed* is a fluid bed in which the gas forms a single opening through which some particles flow and fall on the outside.



**Figure 2** Various types of fluid beds. (From Ref. 21.)

Figure 2 shows various types of fluid beds (21).

The mechanisms by which air affects fluidization have been discussed by various researchers (13,22–26). When the fluidizing velocity is greater than the incipient velocity, bubbles of air rise through the bed causing mixing of particles. Mixing does not generally occur when the bed is fluidized at very low or zero excess gas velocities, because insufficient bubbles are formed to cause bulk displacement of particles. It is the gas passing through the bed in the form of bubbles that determines the degree of mixing. The extent of mixing appears to vary with the particle size. Mixing of particles having a mean particle size of less than approximately  $150\ \mu\text{m}$  decreases as their mean size approaches zero. Different types of beds, described above, are formed depending on the movement of bubbles through the bed. The pattern of movement of the gas phase in and out of bubbles depends on several factors, including minimum fluidization velocity and particle size. These movements affect heat transfer between air bubbles and particles. The air distributor at the bottom of the container has a controlling influence on the uniform distribution of gas, minimization of dead areas, and maximization of particle movement. The most common reason for mixing problems, such as segregation in the fluid bed, is the particle density differences. The main characteristic of the fluid bed is the relative velocity imparted to the particles,  $U_0$ , which is a strong function of the size of the particles and the gas velocity in the bed, and was shown to be given by (27)

$$U_0 \approx aY^0 = 18U_b a / D_b \delta^2$$

where  $a$  is the average particle size,  $U_b$  is the bubble velocity,  $D_b$  is the bubble diameter, and  $\delta$  is the dimensionless bubble spacing. The first expression on the right-hand side of equation applies to fluidized beds with no rotating parts, where shear is induced by the motion of bubbles only.

The extent of segregation can be controlled in part by maintaining high fluidizing velocities and high bowl height–bowl diameter ratio. There are standard air velocities for various processes that can be used as guidelines. The standard velocities are based on the cross-sectional area at the bottom of the product container.

This is calculated by using the following formula for calculating the air velocity.

$$\text{Velocity (m/sec)} = \text{Airflow (m}^3/\text{hr)}/\text{Area (m}^2) \times 3600$$

where airflow in cubic meters per hour (CMH) = airflow (CFM)  $\times$  1.696.

Standard air velocities are based on the application. Low air velocities such as 0.8–1.4 m/sec are required for drying. The velocities are higher during the early stages of drying because of the wet mass present in the bowl, but will be reduced when the product loses its moisture. The objective is to have good particle movement, but to keep the material out of filters. Particle movement and quick drying are important during the agglomeration process. Airflow velocities are normally 1.0–2.0 m/sec.

An indication of good fluidization is a free downward flow of the granulation at the sight glass of the drying container. However, improper fluidization can also be detected by monitoring the outlet air temperature. Every product has a unique constant rate of drying in which the bed temperature remains relatively constant for a significant length of time. Therefore, if the outlet temperature rises more rapidly than anticipated, it will indicate an improper fluidization and the process may have to be stopped, and manual or mechanical intervention may be required to assist the fluidization.

### 3. SYSTEM DESCRIPTION

A fluid bed processor is a system of unit operations involving conditioning of process air, a system to direct it through the material to be processed, and have the same air (usually laden with moisture) exit the unit void of the product. [Figure 3](#) shows a typical fluid bed processor with all the components. These components and their utility in granulation will be reviewed.

An exhaust blower or fan is situated at the downstream end of the fluid bed processor to draw the air through the entire unit. This arrangement provides negative pressure in the fluid bed, which is necessary to facilitate material loading, maintain safe operation, prevent material escape, and carry out the process under good manufacturing practice guidelines, all of which will be discussed later in the chapter.

#### 3.1. Air Handling Unit

A typical air preparation system includes sections for prefiltering air, air heating, air dehumidification, rehumidification, and final high-efficiency particulate air (HEPA) filtering. Generally, outside air is used as the fluidizing medium in a fluid bed processor. For the air to be used for pharmaceutical products, it must be free from dust and contaminants. This is achieved by placing coarse dust filters (30–85%) in the air handling unit (AHU). [Figure 4](#) shows a typical AHU.





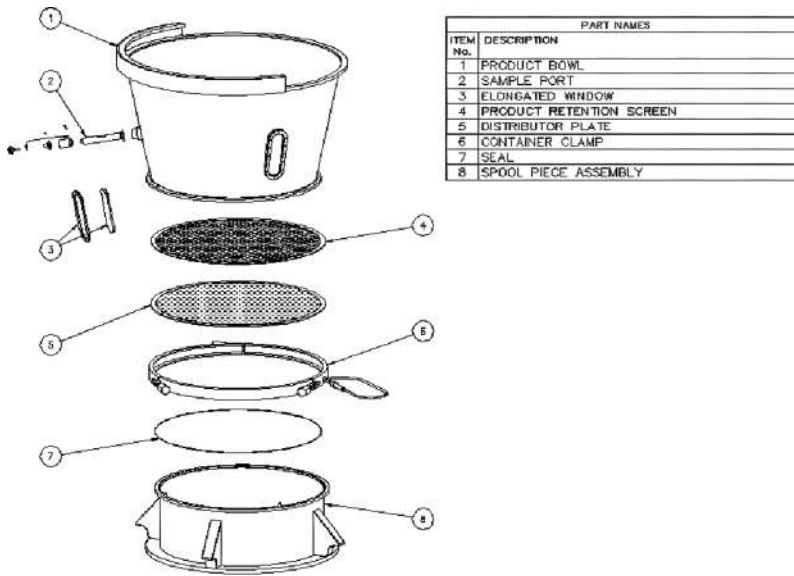
Through years of experience and dealing with various types of materials and various climatic conditions, it is known that incoming air must be controlled very closely. As an example, it has been found that the humidity of the incoming air can greatly affect the quality of spray granulation, drying, or coating. Therefore, air preparation systems are now designed to better control the conditions of the incoming air. After the installation of the filters, distinct heating or cooling sections are installed in the air handler, depending on the geographical location of the plant. In an extremely cold climate, where cooling coils (needed in summer months for maintaining uniform dew point) can freeze in winter, a preheating section is placed ahead of the cooling coils. A typical range for the air after pretreatment that one should aim at achieving is 15–30°C dry bulb and 3–5°C wet bulb. If the unit is located in a tropical or humid climate, the humidity removal section is employed first. The dehumidification of the air is extremely important where the outside air moisture varies over a wide range. In summer, when the outside humidity is high, dehumidification of the process air is required to maintain a specific dew point of the incoming process air. Rehumidification may be necessary during the winter months in some regions. A steam injector is used for rehumidifying the dry air. Generally, lower the process air dew point, higher the affinity to entrain moisture and shorter the process time. When granulating extremely fine powders, inlet air dew point of 15°C is beneficial to reduce static charges and facilitate uniform fluidization. In many processes, when preheating is required, a bypass loop can be used for pre-conditioning the air. This loop allows the required process temperature and humidity to be attained within the system ducts before the product is subjected to fluidization. After the conditioned air leaves the humidification/dehumidification section of the AHU, it is finally heated to the desired process air temperature and then passed through an HEPA filter of about 99.90–99.99% capacity. As the process air is treated and filtered, it is transported by the inlet duct. The air is thus brought into the process vessel in the lower plenum.

### 3.2. Product Container and Air Distributor

With the air at the desired humidity and temperature, it is ready to be passed through the bed of solids. [Figure 5](#) shows a typical product container with the air distributor.

The air must be introduced evenly at the bottom of the product container, through an inlet air plenum. Proper airflow in the inlet air plenum is critical to ensure that equal airflow velocities occur at every point on the air distributor plate. If the air is not properly distributed before it reaches the bottom of the container, uneven fluidization can occur. To facilitate the even flow of powder in the product container, conditioned air is brought in the plenum at various locations by certain manufacturers.

To properly fluidize and mix the material in the container, correct choice of the container and air distributor must be made. The container volume should be chosen, such that the container is filled to at least 35–40% of its total volume and not more than 90% of its total volume. Correct choice of the air distributor is important. These distributors are made of stainless steel and are available with a 2–30% open area. Typically, the distributor should be chosen such that the pressure drop across the product bed and air distributor is 200–300 mm of water column. A fine screen of 60–325 mesh normally covers the air distributor and retains the product in the container. This type of sandwiched construction has been used for the last 30 years in the fluid bed processors. The classic air distributor with the fine product retaining screen is shown in [Figure 5](#).



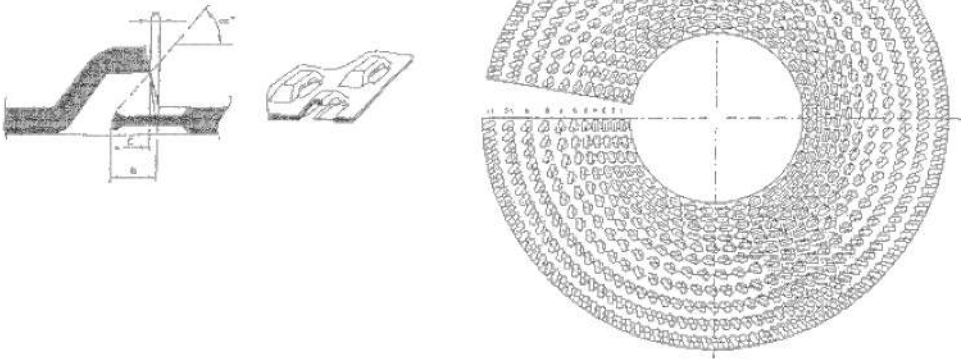
**Figure 5** Product container with air distributor.

Keeping the screen and air distributors clean has been challenging. Partially to address the cleaning problems and partially to provide an efficient processing, a overlap gill plate, shown in [Figure 6\(A\)](#) and (B), was introduced in 1990 (28). These new overlap gill air distributors eliminate the need for a fine screen and perform dual functions as efficient air distributors and product retainers. Other advantages claimed by the manufacturer are validatable clean in place (CIP), controlled fluidization, and directional flow of air to discharge the processed product from the container. Because there is no fine screen, these types of air distributors sometimes sift very fine particles through the plate, thus losing part of the batch in the plenum. This sifting of fine powder through these types of air distributors is of concern when a container containing product is moved around on the production floor, losing some product due to movement of the container. Before selecting these types of single-plate distributors, product particle size and a sifting test should be performed. But these types of air distributors offer advantages when the airflow can be directed to discharge the granulated product from the container in a contained manner. (Please see the [material handling options](#) section.)

### 3.3. Spray Nozzle

A spray is a zone of liquid drops in a gas, and spraying is the act of breaking up a liquid into a multitude of these droplets. The general purpose of spraying is to increase the surface area of a given mass of liquid, in order to disperse it over the product area. The primary concern is with the increase of surface area per unit mass achieved by spraying. The nozzle is an orifice through which liquid is forced, normally by compressed air. This is done by one of three general methods: (a) liquid may be sucked up by a pressure drop created over the nozzle cap, after which compressed air atomizes the liquid stream by disintegrating it with air jets (b) the compressed air operates a piston arrangement that pushes the liquid through the orifice and then lets surface tension create droplets or (c) two pressure streams of liquid impinge upon each other, and so form a highly dispersed, uniform spray.

(A)



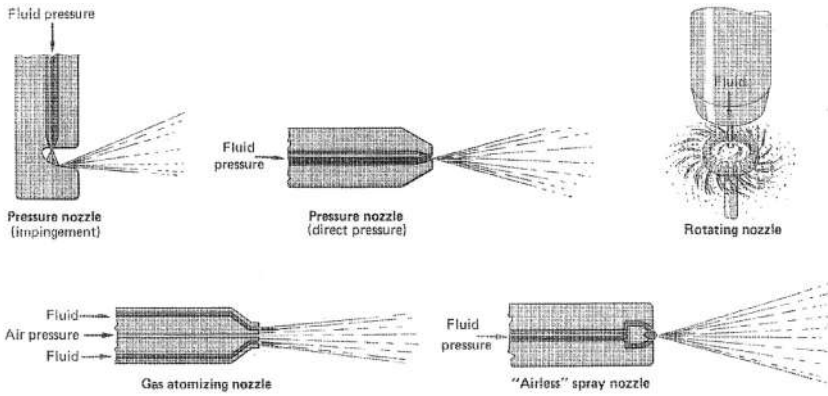
(B)



**Figure 6** (A) Schematic of the overlap gill plate—gill arrangements. (B) Container with the overlap gill distributor. (Courtesy of Niro Pharma Systems.)

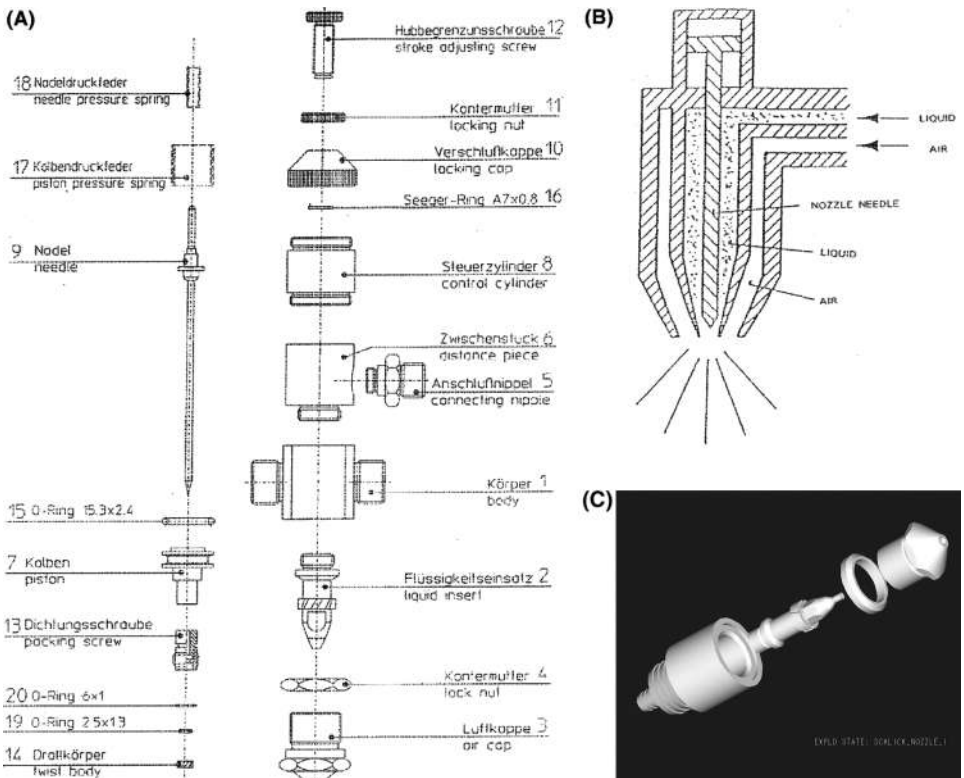
The type of spray system is usually characterized by one of four nozzle designs (29). [Figure 7](#) shows four types of nozzles.

1. *Pressure nozzle*: The fluid under pressure is broken up by its inherent instability and its impact on the atmosphere, on another jet, or on a fixed plate.
2. *Rotating nozzle* (rotary atomizer): Fluid is fed at a low pressure to the center of a rapidly rotating disk, and the centrifugal force breaks up the fluid. These types of nozzles are used mainly in a spray drying application.
3. *Airless spray nozzle*: The fluid is separated into two streams that are brought back together at the nozzle orifice, where upon impingement, they form drops.
4. *Gas atomizing nozzle* (two-fluid nozzle): The two-fluid (binary) nozzle where the binder solution (one fluid) is atomized by compressed air (second fluid) is the most commonly used nozzle for fluid bed granulation ([Fig. 8A–C](#)). These nozzles are available as single-port or multiport designs. Generally, the single-port nozzles are adequate up to the 100 kg batch, but for larger-size batches multiport nozzles, such as either three-port ([Fig. 9](#)) or six-port ([Fig. 10](#)) nozzles are required. When these nozzles are air atomized, the spray undergoes three distinct phases. In the first, the compressed air



**Figure 7** Types of nozzle. (From Ref. 29.)

(gas) expands, essentially adiabatically, from the high pressure at the nozzle to that at the fluid bed chamber. The gas undergoes a Joule–Thomson effect, and its temperature falls. In the second, the liquid forms into discrete drops. During this atomization, the liquid’s specific surface area usually increases 1000 times. In the third, the drops travel after being formed, until they become completely dry or impinge on the product particles. During



**Figure 8** (A) Schematic nozzle showing different parts. (B) Schematic of two-fluid nozzle. (C) Typical single-port nozzle. (Courtesy of Niro Pharma Systems.)



**Figure 9** Three-port nozzle. (Courtesy of the Vector Corporation.)

this phase, the solvent evaporates and the diameter of the drops decreases. The energy required to form a drop is the product of the surface tension and the new surface area. About 0.1 cal/g energy is needed to subdivide 1 g of water into 1  $\mu\text{m}$  droplets. The air pressure required to atomize the binder liquid is set by means of a pressure regulator. The spray pattern and spray angle are adjusted by adjusting the air cap.

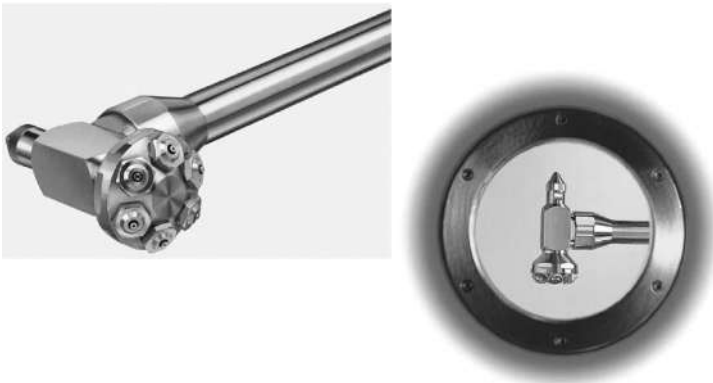
Optimum atomization is achieved by fine adjustment of the air cap and atomization air pressure measured at the nozzle. The binder solution is delivered to the nozzle port through a spray lance and tubing. The peristaltic or positive displacement pump is commonly used to pump the binder solution. The pneumatically controlled nozzle needle prevents the binder liquid from dripping when the liquid flow is stopped. Nozzle port openings of between 0.8 and 2.8 mm in diameter are most common and are interchangeable.

The two-fluid nozzle in its simplified model is based on energy transmission as shown below:

Energy + Liquid  $\longrightarrow$  Two fluid nozzle  $\longrightarrow$  Droplets + Heat

The ratio of energy dissipation by heat and by the droplet-making process is difficult to measure. Masters (30) suggested that  $< 0.5\%$  of applied energy is utilized in liquid breakup. Virtually, the whole amount is imparted to the liquid and air as kinetic energy.

Six-headed spray nozzle for fluid bed granulator



**Figure 10** Six-port nozzle. (Courtesy of the Glatt Group.)

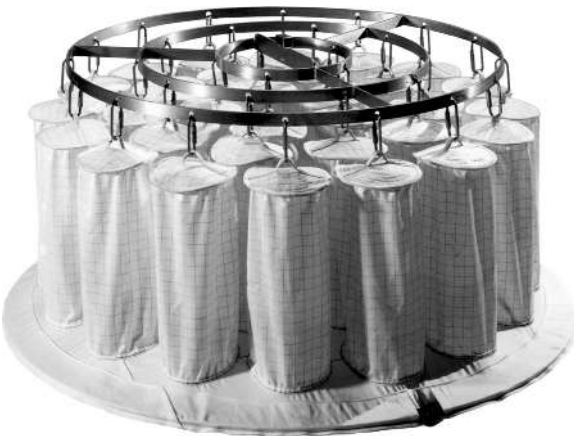
### Conventional bag filters: single and dual chamber



**Figure 11** Conventional bag filters. (Courtesy of the Glatt Group.)

### 3.4. Disengagement Area and Process Filters

Once the air leaves the product bed, fine particles need to be separated from the air stream. Two zones are used in the fluid bed to separate the particles from the air stream—the disengagement area and the exhaust filter. In the disengagement area, larger particles lose momentum and fall back into the bed. The velocity of the process air is the highest at the center of the processor and approaches zero at the sidewalls. A process-air filter system removes the particles from the exhaust air. The process air is filtered by using bags or cartridges. The bag filters are widely used and are available with single-bag or with double-bag configuration, where one bag is mechanically shaking the particles while the other bag remains functional, thus facilitating uninterrupted fluidization. This alternate shaking of dual bags allows the process to be consistent from batch to batch. These filter bags can be constructed out of nylon, polyester, polypropylene, and polytetrafluoroethylene (PTFE) lined materials (Figs. 11–13). To dissipate the potential static charges from the product particles, conductive fabrics are also available and are recommended.



**Figure 12** Conventional bag filters with hanging arrangements. (Courtesy of the Vector Corporation.)

Cartridge filters lined with PTFE were introduced to the industry in the 1980s (31). The standard filtration system normally contains a multiple-cartridge filter system with an alternating blowback pulse arrangement allowing continuous product fluidization. A cleanable polyester 2  $\mu\text{m}$  material is utilized for processing water-soluble and -insoluble materials, which has an electrical conductivity for static-free operation. Recently, cartridges made of stainless steel suitable for CIP have been introduced (32). Various suppliers of the process equipment have filter arrangements. The vertical filter cartridge claimed to provide better cleaning, however, requires mechanical means to bring the filters down to replace them. Cartridge filters located at an angle do provide better access to take them out from and place them in the unit. They are equally effective. Figure 14(A) and (B) shows the different cartridge-filter arrangements in the fluid bed processor. The stainless steel cartridge filters (Fig. 15) are an expensive alternative to the cloth filter bags, but provide the possibility of cleaning, using the automated CIP system. For a potent compound processing these cartridge filters with a CIP capability is normally recommended.

During the granulation or drying process, cloth filters are mechanically shaken to dislodge any product adhered, while cartridge filters use low-pressure compressed air blowback system to do the same. Figure 14(A) and (B) shows various PTFE lined cartridge filters used in the fluid bed processors.

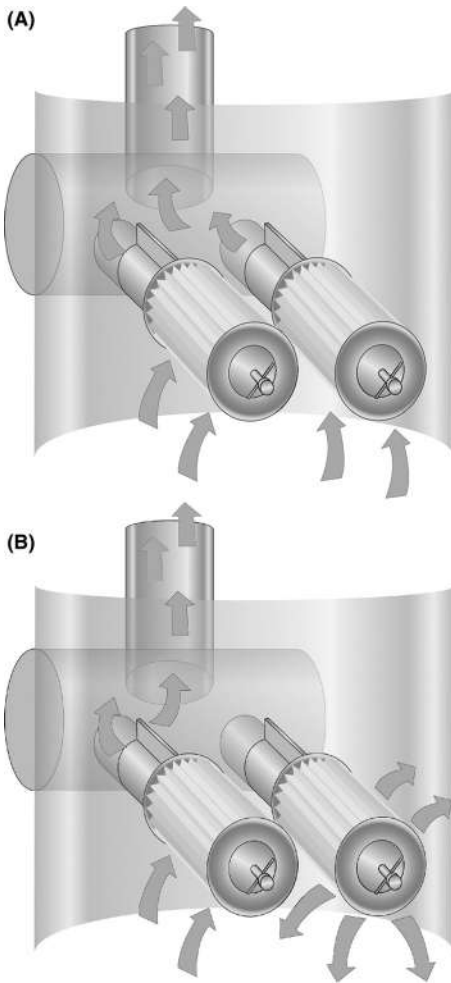
### 3.5. Exhaust Blower or Fan

Once the air leaves the exhaust filters, it travels to the fan. The fan is on the outlet side of the system, which keeps the system at a lower pressure than the surrounding atmosphere. The airflow is controlled by a valve or damper installed just ahead or after the fan. Manufacturers of the fluid bed normally make the selection of the fan,



**Figure 13** Production size unit with filter bags. (Courtesy of the L.B. Bohle Group.)





**Figure 14** (A) Cartridge filter during processing mode. (B) Cartridge filters during cleaning mode. (Courtesy of the Vector Corporation.)

based on the layout and the complexity of the system. Fan size is determined by calculating the pressure drop ( $\Delta P$ ), created by all the components that make up the fluid bed processor, including the product at the highest design airflow volume.

### 3.6. Control System

A fluid bed granulation process can be controlled by pneumatic analog control devices, or state of the art, programmable logic controllers (PLCs) or computers. The electronic based control system offers not only reproducible batches according to the recipe but also a complete record and printout of all the process conditions. Process control technology has changed very rapidly and it will continue to change as advances in computer technology take place and as the cost of control systems fall. The CFR Part 11 requirements (33) mandated by the US FDA has created a number of approaches to ensure that these control systems are complying with the



**Figure 15** Stainless steel filters. (Courtesy of the Glatt Group.)

current regulation. The concept of process analytical technology (PAT) is covered in another chapter of this book, as it pertains to the process control, and is discussed further in this chapter, as it pertains to fluid bed processing in particular.

### 3.7. Solution Delivery System

The liquid delivery systems operate at a low pressure. A peristaltic pump capable of delivering fluid at a controlled rate is desirable. The liquid is transported from the solution vessel through the tubing, and atomized using a two-fluid (binary) nozzle in the fluid bed processor.

### 3.8. Laboratory Units

During feasibility of process development, the supply of active ingredient is scarce. A smaller unit with all the functionalities of a larger unit is desirable. The process parameters developed at this stage may not be fully scalable; however, one can process 20–100 g of material. Figures 16–18 show various smaller-size units that can be used for process feasibility and preliminary development work.

## 4. PARTICLE AGGLOMERATION AND GRANULE GROWTH

Agglomeration can be defined as the size enlargement process, in which the starting material is fine particles and the final product is an aggregate in which primary particles can still be identified. The granules are held together with bonds formed by the binder used to agglomerate. Various mechanisms of granule formation have been described in the literature (34–36). The chapter on the theory of granulation in this book discusses the theory of granule growth. To summarize, the researchers have suggested three mechanisms for granule formation. These are

1. Bridges due to *immobile liquids* form adhesional and cohesive bridging bonds. Thin adsorption layers are immobile and can contribute to the bonding of fine particles under certain circumstances.
2. *Mobile liquids* where interfacial and capillary forces are present.
3. *Solid bridges* formed due to crystallization of dissolved substances during drying.



**Figure 16** Tabletop unit. (Courtesy of Pro-cept.)

The type of bonds formed approaches through four transition states, described by Newitt and Conway-Jones (34) as (1) pendular, (2) funicular, (3) capillary, and (4) droplet, which normally happens during spray drying.

Tardos et al. (37) investigated comprehensive model of granulation. They developed a pendular bridge apparatus that can be used to test the bridge-forming characteristics of the binder, and to determine binder penetration and spreading rates and the critical time of binder strengthening. Iveson (38) reported a mathema-



**Figure 17** Tabletop fluid bed processor. (Courtesy of the Glatt Group.)



**Figure 18** Lab unit. (Courtesy of Heinen, Germany.)

tical model for granule coalescence during granulation. He found that current models had one of two limitations; either they only consider whether a bond formed on impact is strong enough to survive subsequent impacts or they fail to consider the possibility of bond rupture after formation at all. He developed a new model that takes into account both the effects of bond strengthening with time and the distribution of impact forces. He suggested that his model be combined with existing models that predict whether or not two granules stick initially on impact, to be able to predict the probability of permanent coalescence.

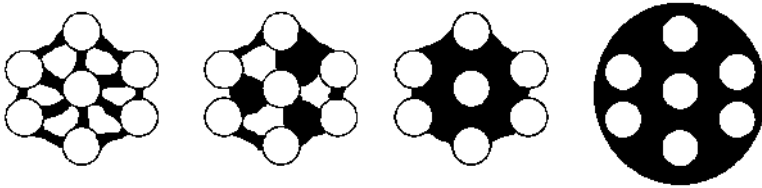
Most of the fluid bed granulated products require much less wetting than the high-shear granulation or spray dryer processed product. In the fluid bed granulation process, the particles are suspended in the hot air stream and the atomized liquid is sprayed on it. The degree of bonding between these primary particles to form an agglomerated granule depends on the binder used, the physicochemical characteristics of the primary particles being agglomerated, and the process parameters.

Schaefer et al. (39) and Smith and Nienow (40) have reported a description of the growth mechanisms in the fluid bed, where the bed particles are wetted by liquid droplets in the spray zone. Atomized liquid from the nozzle tends to spread over the particle surface, as long as there is an adequate wettability of the particle by the fluid (41) Wet particles, on impact, form a liquid bridge and solidify as the agglomerate circulates throughout the remainder of the bed. Solid bridges then hold particles together. The strength of the binder determines whether these particles stay as agglomerates. These binding forces should be larger than the breakup forces and in turn depend on the size of the solid bridge. The breakup forces arise from the movement of the randomized particles colliding with each other and are related to the excess gas velocity and particle size.

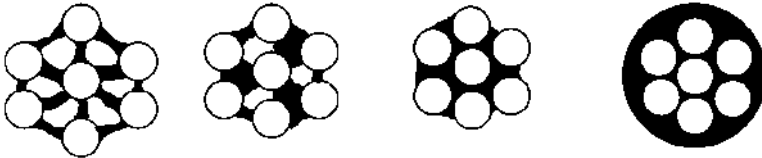
If the binding forces are in excess of the breakup forces, either in the wet state or in the dry state, uncontrolled growth will proceed to an overwetted bed or production of excessive fines, respectively. If a more reasonable balance of forces is present, con-



(A)



(B)



Pendular

Funicular

Capillary

Droplet

**Figure 20** States of liquid saturation. Liquid bridging state of agglomerates undergoing (A) binding liquid addition and (B) densification.

agglomerate and continue the transition from the pendular state to the capillary state.

The uniqueness of the fluid bed agglomeration process is in, how the liquid addition and drying (evaporation) steps are concurrently carried out. When the granulation liquid is sprayed into a fluidized bed, the primary particles are wetted and form together with the binder relatively loose and very porous agglomerates. Densification of these agglomerates is brought about solely by the capillary forces present in the liquid bridges. It is therefore important that the quantity of liquid sprayed into the bed should be relatively large compared with that used in high-shear granulation.

Drying a wet product in a fluid bed is a separate topic, but during the granulation process it becomes an integral part of the process; hence, understanding fluid bed drying is important before we review the agglomeration process.

## 5. FLUID BED DRYING

Drying is usually understood to be the removal of moisture or solvent. Drying involves heat transfer and mass transfer. Heat is transferred to the product to evaporate liquid, and mass is transferred as vapor in the surrounding gas; hence, these two phenomena are interdependent. The drying rate is determined by the factors affecting the heat and mass transfer. The transfer of heat in the fluid bed takes place by convection. Convection is the transfer of heat from one point to another within a fluid (gas, solid, liquid), by the mixing of one portion of the fluid with another. The removal of moisture from a product granulated in the fluid bed granulator or in other equipment essentially removes the added water or solvent. This *free moisture content* is the amount of moisture that can be removed from the material by drying at a specified temperature and humidity. The amount of moisture that remains associated with the material under the drying conditions specified is called the equilibrium moisture content (EMC).

The evaporation rate of liquid film surrounding the granule being dried is related to the rate of heat transfer by the equation:

$$\frac{dw}{dt} = h \frac{A}{H} \delta T$$

where  $dw/dt$  is the mass transfer rate (drying rate),  $h$  is the heat transfer coefficient,  $A$  is the surface area,  $H$  is the latent heat of evaporation, and  $\delta T$  is the temperature difference between the air and the material surface.

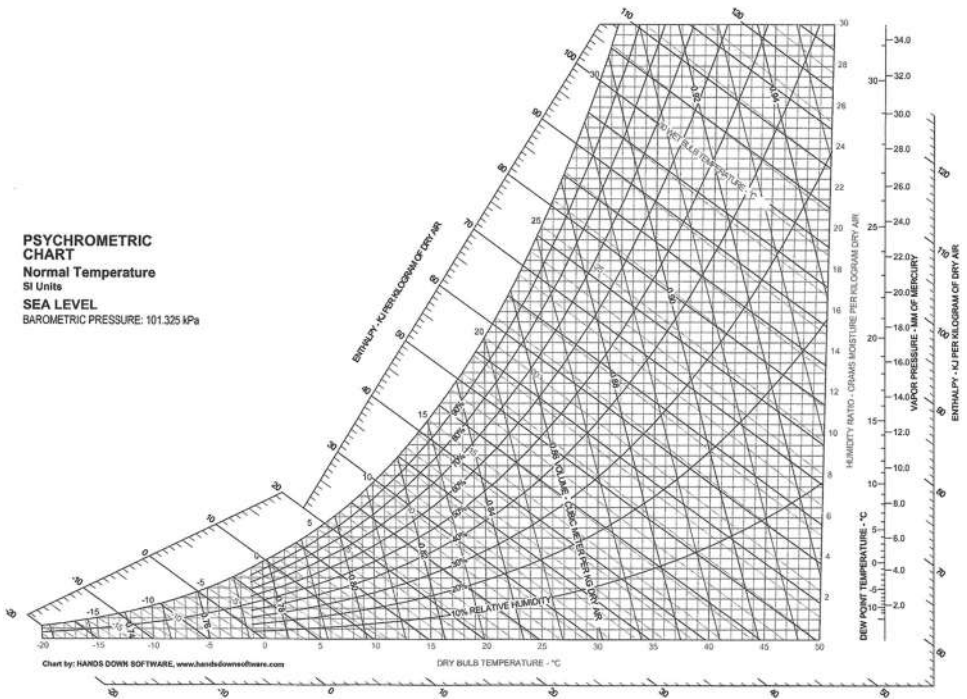
Because fluid bed processing involves drying of a product in suspended hot air, the heat transfer is extremely rapid. In a properly fluidized processor, the product temperature and the exhaust air temperatures should reach equilibrium. Improper air distribution and hence poor heat transfer in a fluidized bed causes numerous problems such as caking, channeling, or sticking. The capacity of the air (gas) stream to absorb and carry away moisture determines the drying rate and establishes the duration of the drying cycle. Controlling this capacity is the key to controlling the drying process. The two elements essential for this control are inlet air temperature and airflow. The higher the temperature of the drying air, the greater its vapor holding capacity. Since the temperature of the wet granules in a hot gas depends on the rate of evaporation, the key to analyzing the drying process is psychrometry (44–46).

Psychrometry is defined as the study of the relationships between the material and energy balances of water vapor–air mixture. Psychrometric charts (Fig. 21) simplify the crucial calculations of how much heat must be added and how much moisture can be added to the air. The process of drying involves both heat and mass transfer. For drying to occur, there must be a concentration gradient, which must exist between the moist granule and the surrounding environment. As in heat transfer, the maximum rate of mass transfer that occurs during drying is proportional to the surface area, the turbulence of the drying air, the driving force between the solid and the air, and the drying rate. Because the heat of vaporization must be supplied to evaporate the moisture, the driving force for mass transfer is the same driving force required for heat transfer, which is the temperature difference between the air and the solid.

Schäfer and Worts (47) have shown that the higher the temperature difference between the incoming air and the product, the faster the drying rate. Therefore, product temperature should be monitored closely to control the fluidized bed drying process.

During fluid bed drying, the product passes through three distinct temperature phases (Fig. 22). At the beginning of the drying process, the material heats up from the ambient temperature to approximately the wet-bulb temperature of the air in the dryer. This temperature is maintained until the granule moisture content is reduced to the critical level. At this point, the material holds no free surface water, and the temperature starts to rise further.

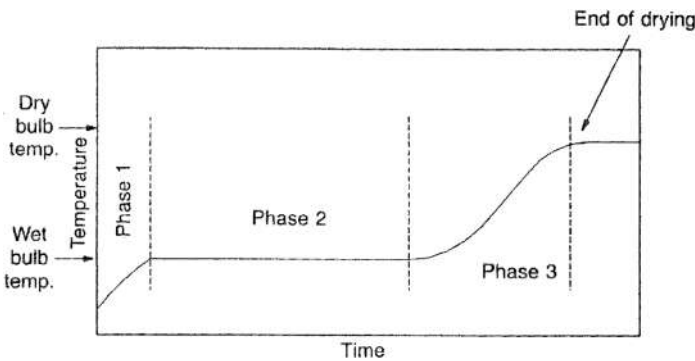
The drying capacity of the air depends on the relative humidity (RH) of the incoming air. At 100% RH, the air is holding the maximum amount of water possible at a given temperature, but if the temperature of the air is raised, the RH drops, and the air can hold more moisture. If air is saturated with water vapor at a given temperature, a drop in the temperature will force the air mass to relinquish some of its moisture through condensation. The temperature at which moisture condenses is the dew point temperature. Thus, the drying capacity of the air varies significantly during processing. By dehumidifying the air to a preset dew point, incoming air can be



**Figure 21** Psychrometry chart.

maintained at a constant drying capacity (dew point) and hence provide reproducible process times.

Julia Gao et al. (48) studied the importance of inlet air velocity to dry the product granulated in a high-shear granulator and dried in a fluid bed dryer. The manufacturing process involved granulating the dry components containing 63% water-insoluble, low-density drug in a high-shear granulator, milling the wet mass, and drying in a fluid bed dryer. The granules were dried at an inlet air temperature of 60°C. Two different air velocities were examined for their effect on drying uniformity of the product. The authors observed that the excessive velocity, indicated by



**Figure 22** Product temperature changes during drying. (From Ref. 21.).



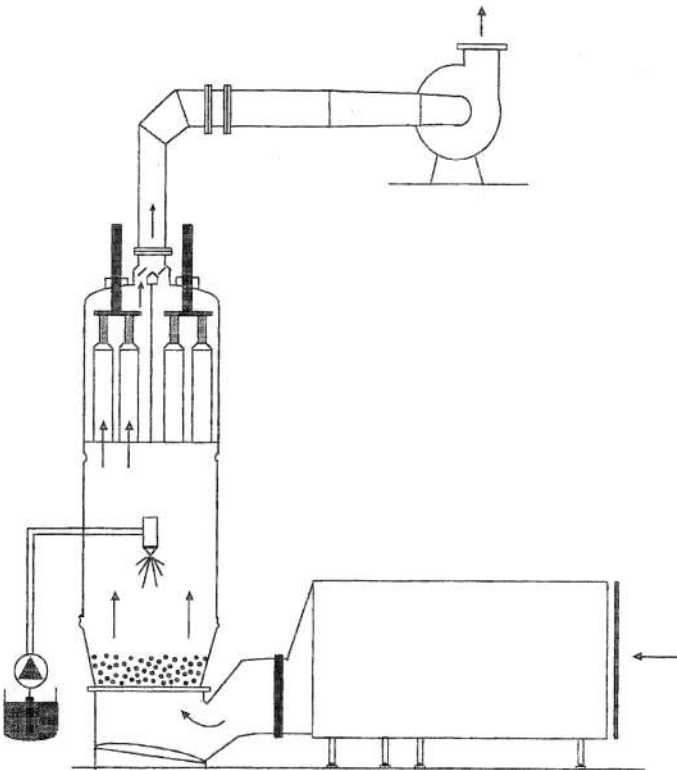
the rapid rise in the exhaust air temperature resulted in nonuniform drying of the product besides resulting in an inefficient process.

## 6. PROCESS AND VARIABLES IN GRANULATION

### 6.1. Process

As with any granulating system, in fluid bed granulation processing, the goal is to form agglomerated particles through the use of binder bridges between the particles. To achieve a good granulation, the particles must be uniformly mixed, and the liquid bridges between the particles must be strong and easy to dry. Therefore, this system is sensitive to the particle movement of the product in the unit, the addition of the liquid binder, and the drying capacity of the air. The granulation process in the fluid bed requires a binary nozzle, a solution delivery system, and compressed air to atomize the liquid binder. Figure 23 shows the equipment setup for granulation using the fluid bed processor.

Thurn (49), in a 1970 thesis, investigated the details of the mixing, agglomerating, and the drying operations, which take place in the fluid bed process. Results indicated that the mixing stage was particularly influenced by the airflow rate and the air volume. It was suggested that the physical properties of the raw materials, such as hydrophobicity, might exert a strong influence on the mixing stage. At the granulation stage, particular attention was paid to the nozzle, and it was concluded that a



**Figure 23** A typical fluid bed processor setup for fluid bed granulation.

binary design (two-fluid) nozzle gave a wide droplet size distribution, yielding a homogenous granule. The need for strong binders was recommended to aid granule formation and it was suggested that the wettability of the raw materials required particular attention. Several research papers have been published, on the influence of raw material (47–65), binder type (5,8,47,49,59,61,66–76), binder concentration, and binder quantity (8,52,57,61,63,66,68–70,73–75,77–93). Recently, researchers granulated various products using foam instead of solution and found that fluid bed granulation using foams of aqueous solutions of low molecular weight Methocel hypromellose polymers (E3PLV and E6PLV) or conventional solution did not have an effect on the physical properties of granules or tablets compressed from these granules. However, they found that due to foam, the granule formation is achieved more efficiently. It was further claimed that variables associated with nozzles were eliminated by using foam, and water requirement was reduced along with shorter production time (94).

Each phase of the granulation process must be controlled carefully to achieve process reproducibility. When the binder liquid is sprayed into a fluidized bed, the primary particles are wetted and form together with the binder, relatively loose and very porous agglomerates. Densification of these agglomerates is brought about, almost solely by the capillary forces present in the liquid bridges. It is therefore important that the liquid binder sprayed into the bed should be relatively large in quantity, compared with that used in high- or low-shear granulation processes. During spraying, a portion of the liquid is immediately lost by evaporation, so the system has little tendency to pass beyond the liquid bridge phase. The particle size of the resulting granule can be controlled to some extent by adjusting the quantity of binder liquid and the rate at which it is fed, i.e., the droplet size. The mechanical strength of the particles depends principally on the composition of the primary product being granulated and the type of the binder used. Aulton et al. (83) found that lower fluidizing air temperature, a dilute solution of binder fluid, and a greater spray rate produced better granulation for tableting.

## 6.2. Variables

Factors affecting the fluid bed granulation process can be divided into three broad categories:

1. Formulation related variables
2. Equipment related variables
3. Process related variables

### 6.2.1. Formulation Related Variables

**6.2.1.1. Properties of Primary Material.** Ideally, the particle properties desired in the starting material include a low particle density, a small particle size, a narrow particle size range, the particle shape approaching spherical, a lack of particle cohesiveness, and a lack of stickiness during the processing. Properties such as cohesiveness, static charge, particle size distribution, crystalline or amorphous nature, and wettability are some of the properties which have an impact on the properties of granules formed. The cohesiveness and static charges on particles present fluidization difficulty. The same difficulties were observed when the formulation contained hydrophobic material or a mixture of hydrophilic and hydrophobic materials. The influence of hydrophobicity of primary particles has been shown by Aulton and

Banks (17) where they demonstrated that the mean particle size of the product was directly related to wettability of the primary particles expressed as  $\cos \theta$  (where  $\theta$  is the contact angle of the particles). It was also reported that as the hydrophobicity of the mix is increased, a decrease in granule growth is observed. Aulton, Banks, and Smith, in a later publication, showed that addition of a surface-active agent, such as sodium laurel sulfate, improves the fluidized bed granulation (57). In a mixture containing hydrophobic and hydrophilic primary particles, granule growth of hydrophilic materials takes place selectively, creating content uniformity problems. Formulating a controlled release granulation can be accomplished by using fluid bed granulation. A controlled release matrix formulation of Naproxen was successfully developed using fluid bed granulation (95).

**6.2.1.2. Low-Dose Drug Content.** Wan et al. (96) studied various methods of incorporating a low-dose drug, such as chlorpheniramine maleate, in lactose formulation with Povidone (PVP) as the granulating binder. They concluded that the randomized movement of particles in the fluid bed might cause segregation of the drug and that uniform drug distribution was best achieved by dissolving the drug in the granulating solution. The mixing efficiency of drug particles with the bulk material was found to increase, in the proportion of the granulating liquid used to dissolve the drug. The optimum nozzle atomizing pressure was deemed to be important to avoid spray drying the drug particles or overwetting, which creates uneven drug distribution. Higashide et al. (97) studied the fluidized bed granulation using 5-fluorouracil in a concentration of 0.3% in 1:1 mixture of starch and lactose. Hydroxy propyl cellulose (HPC) was used as the binder. The ratios of starch and lactose contained in the granules were measured gravimetrically. The researchers found that a larger amount of the drug and starch was found in larger granules than in smaller granules. The results were attributed to the hydrophobicity of the 5-fluorouracil, starch, and the hydrophilicity of lactose.

**6.2.1.3. Binder.** A more general discussion on the types of binders used in the pharmaceutical granulations and their influence on the final granule properties was presented in a previous chapter of this book. Different binders have different binding properties, and the concentration of the individual binder may have to be changed to obtain similar binding of primary particles. Thus, the type of binder, binder content in the formulation, and concentration of the binder have a major influence on granule properties. These properties include friability, flow, bulk density, porosity, and size distribution.

Davies and Gloor (98,99) reported that the types of binder such as povidone, acacia, gelatin, and HPC, all have different binding properties that affect the final granule properties mentioned above. Hontz (91) investigated microcrystalline cellulose concentration, inlet air temperature, binder (PVP) concentration, and binder solution concentration effects on tablet properties. Binder and microcrystalline cellulose concentration were found to have a significant effect on tablet properties. Alkan and Ulusoy (76) studied binder (PVP) addition in solution and as a dry powder in the powder mix. They found a larger mean granule size when the dry binder was granulated with ethanol. However, when the binder was in solution, the granules produced were less friable and more free-flowing. A similar finding was confirmed by other researchers (92,93). Binder temperature affects the viscosity of the solution, and in turn affects the droplet size. Increased temperature of the binder solution reduces the viscosity of the solution, reducing the droplet size, and hence producing smaller mean granule size. Binder solution viscosity and concentration affect the droplet size of the binder. Polymers, starches, and high molecular weight PVP cause

increased viscosity, which in turn creates a larger droplet size and subsequently a larger mean granule particle size (68).

Diluted binders are preferred because they facilitate finer atomization of the binder solution, provide control of the particle size, reduce friability, and increase the bulk density, even though the tackiness or binding strength may suffer (8,69,79,83,99).

**6.2.1.4. Binder Solvent.** In most instances, water is used as the solvent. The selection of solvent, such as aqueous or organic, depends on the solubility of the binder and the compatibility of the product being granulated. Generally, organic solvents, due to their rapid vaporization from the process, produce smaller granules than the aqueous solution. Different solvents have different heats of vaporization as shown in Table 1. Incorporating the binder or a mixture of binders of low melting point with the drug substance in the dry form can eliminate the requirement of a solvent for the binder. The temperature of the incoming air is sufficient to melt the binder and form the granules. Seo et al. (100) studied fluid bed granulation using meltable polymers such as polyethylene glycol (PEG) 3000, or esters of polyethylene glycol and glycerol (Gelucire 50/13). They showed that melt agglomeration by atomization of a melted binder in a fluid bed occurs by initial nucleation followed by coalescence between nuclei. The nuclei are formed by immersion of the solid particles in the binder droplets, provided that the droplet size is larger than the size of the solid particles. The agglomerate growth rate is supposed to be practically independent of the droplet size, if the binder viscosity is so low that the droplets are able to spread over the agglomerate surface. If the droplets are unable to spread, because of high viscosity, the growth rate is supposed to be inversely proportional to the droplet size. These effects of droplet size are different from those seen in aqueous fluid bed granulation, probably because the aqueous process is affected by the evaporation of the binder liquid.

## 6.2.2. Equipment Related Variables

**6.2.2.1. Design.** To fluidize, and thus granulate and dry the product, a certain quantity of process air is required. The volume of the air required will vary based on the amount of material that needs to be processed. The ratio of drying capacity of the process air to the quantity of the product needs to be maintained constant throughout the scaling-up process. However, some suppliers of the equipment provide higher drying capacity for their laboratory unit, but cannot maintain the same ratio for the production units. This lack of proportionality reduces the drying capacity per unit volume of the process air, resulting in a longer process time in the production units. The current design of the fluid bed is a modular one, where multiple

**Table 1** Heats of Vaporization for Commonly Used Solvents

Solvent	Solvent boiling point (°C)	Density (g/mL)	Heat of vaporization (kcal/g)
Methylene chloride	40.0	1.327	77
Acetone	56.2	0.790	123.5
Methanol	65.0	0.791	262.8
Ethanol	78.5	0.789	204.3
Isopropanol	82.4	0.786	175.0
Water	100.0	1.000	540.0

processes such as drying, granulating, Wurster coating, rotary fluid bed granulating or coating, etc., can be carried out by changing the container specially designed for the individual process.

**6.2.2.2. Air Distributor Plate.** The process of agglomeration and attrition due to random fluidization requires control of the particle during the granulation process. This is a complex phenomenon due to the prevailing fluidizing conditions and a particle size distribution, which undergoes changes during the process. As the conditioned air is introduced through the lower plenum of the batch fluid bed, the fluidizing velocity of a given volume of air determines how fluidization will be achieved.

Perforated air-distributor plates covered with the 60–325-mesh fine stainless steel screen, described previously, provide an appropriate means of supplying air to the product. These plates are identified by their percentage of open area. Air distributor plates that have 4–30% open area are normally available. These interchangeable plates provide a range of loading capacities, so that batches of various sizes can be produced efficiently and with uniform quality. To prevent channeling, an operator can select a plate with optimum lift properties. For example, a product with low bulk density requires low fluidizing velocity. A distributor plate having a small open area to give a large enough pressure drop may provide uniform fluidization of such a product without reaching entraining velocity and impinging the process filters. Alternatively, a product with higher bulk density can be fluidized and processed using a plate with a larger open area. The air distributor plate consists of a perforated plate and a fine mesh screen. This arrangement sometimes causes problems like product leakage, due to a torn screen, and difficulty in cleaning without separating the perforated plate and the fine mesh screen. To overcome these deficiencies, various air distributor design have been recently introduced. These distributor designs were discussed earlier in the chapter.

**6.2.2.3. Pressure Drop.** The blower creates flow of air through the fluid bed processor, or a fan located downstream from the process chamber. This fan imparts motion and pressure to air using a paddle-wheel action. The moving air acquires a force or pressure component in its direction of motion, because of its weight and inertia. This force is called velocity pressure and is measured in inches or millimeters of water column. In operating duct systems, a second pressure that is independent of air velocity or movement is always present. Known as static pressure, it acts equally in all directions. In exhaust systems such as fluid bed processors, a negative static pressure exists on the inlet side of the fan. The total pressure is thus a combination of static and velocity pressures. Blower size is determined by calculating the pressure drop ( $\Delta P$ ) created by all the components of the fluid bed processing system. Proper selection of the blower is essential in fluid bed design. A blower with appropriate  $\Delta P$  will fluidize the process material adequately. However, a blower without enough  $\Delta P$  will not allow proper fluidization of the product, resulting in longer process time and improper granulation. A similar effect can be seen when a product with unusually high bulk density is processed in place of normal pharmaceutical materials, or an air distributor offers high resistance due to its construction. This creates a pressure drop that the blower was not designed to handle. A properly sized blower or fan should develop sufficient  $\Delta P$  so that the exhaust damper can be used in the 30–60% open position. Any additional components such as scrubbers, exhaust HEPA, police filters, or additional components in the air handling unit would require a larger blower/static pressure which can be recommended by the supplier of the fluid bed processor.

**6.2.2.4. Shaker/Blow Back Cycle Mechanism.** To retain entrained particles of a process material, process filters are used. To maintain these filters from building up layers of fine process material, and causing a higher pressure drop and thus improper fluidization, these filters are cleaned during the granulation process. When bag filters are used, mechanical means are used to clean them. This mechanical cleaning of the bag filters requires a cessation of airflow and thus the fluidization during the filter cleaning process. In units with a single-bag house, this results in a momentary *dead bed*, where no fluidization takes place. This interruption in the process extends the process time. To avoid process interruptions, a multishaking filter bag arrangement is desired, where the granulation process is continuous. Using bag filters with a blowback or using cartridge filters where air under pressure is pulsed through the filters also achieves the continuous process. Generally, filters should be cleaned frequently during the granulation step, to incorporate the fines back in the granulation. This is possible if the cleaning frequency is high and the period between the filter cleaning is short. Rawley (101) reported the effect of bag-shake/interval cycle. He discussed the possibility of improving particle size distribution by optimizing the shake time and the corresponding interval between bag shakes.

The following general guidelines for filter cleaning frequency and duration are recommended:

*Single-bag shaker unit:* Frequency, 2–10 min between filter cleaning, 5–10 sec for shaking. This may vary as the fine powders form granules, and the frequency between the shakes or duration of shaking interval, can be extended. In any case, the occurrence of a collapsed bed should be kept at a minimum in a single-shaker unit.

*Multiple bags shaker unit:* Since this is a continuous process, frequency of shaking for each section is approximately 15–30 sec between filter cleanings, and about 5 sec for shaking the filters. If a low-pressure blow back system is used for the bags, the frequency of cleaning is about 10–30 sec.

*Cartridge filters:* These offer continuous processing and require cleaning frequency of 10–30 sec.

The cleaning frequency and cleaning duration are now offered as an automated system, where instead of having to base the cleaning frequency on time, the trigger point for filter cleaning is the buildup of a pressure drop across the filters. This automates the process and eliminates operator input.

**6.2.2.5. Other Miscellaneous Equipment Factors.** Granulator bowl geometry is considered to be a factor that may have an impact on the agglomeration process. The fluidization velocity must drop from the bottom to the top rim of the bowl by more than half to prevent smaller, lighter particles from being impinged into the filter, creating segregation from heavier product components in the bowl. Generally, the conical shape of the container and expansion chamber is preferred, where the ratio of cross-sectional diameter of the distributor plate to the top of the vessel is 1:2. Most of the suppliers of this equipment offer units with a multiprocessor concept where a single unit can be used for drying, agglomerating, air suspension coating, or rotary fluid bed processing by changing the processing container, while the rest of the unit is common. This approach does eliminate the concerns about the geometry of the processor, because of the way these units are constructed.

### 6.2.3. Process Related Variables

The agglomeration process is a dynamic process where a droplet is created by a two-fluid nozzle, and deposited on the randomly fluidized particle. The binder solvent evaporates, leaving behind the binder. Before all of the solvent is evaporated, other randomized particles form bonds on the wet site. This process is repeated numerous times to produce the desired agglomerated product. There are a number of process variables that control the agglomeration. Process variables, most important to consider are listed as follows:

1. Process inlet air temperature
2. Atomization air pressure
3. Fluidization air velocity and volume
4. Liquid spray rate
5. Nozzle position and number of spray heads
6. Product and exhaust air temperature
7. Filter porosity and cleaning frequency
8. Bowl capacity

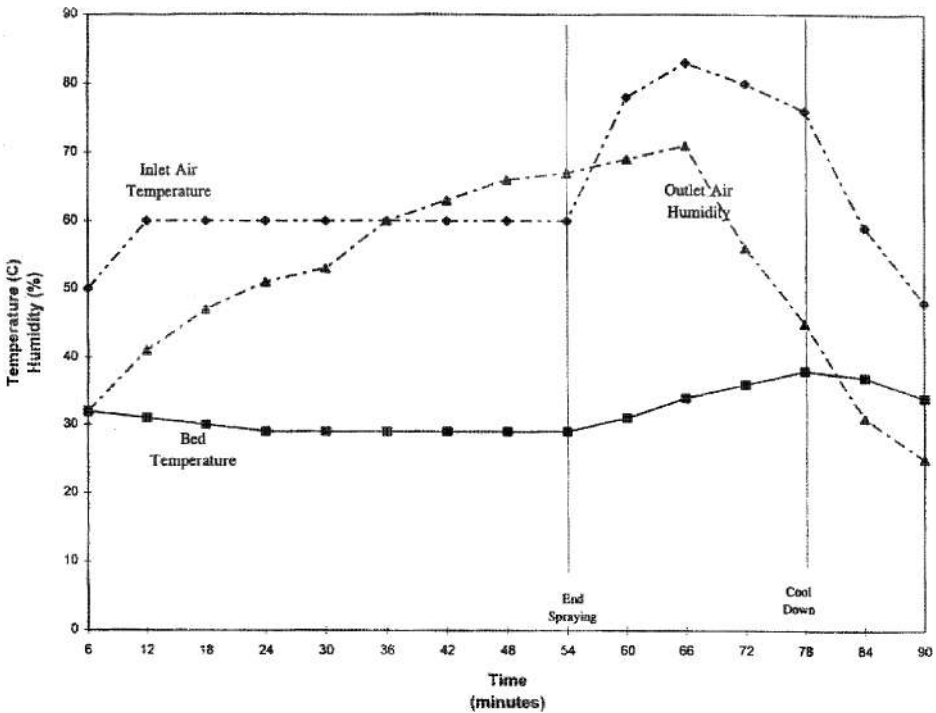
These process parameters are interdependent and can produce the desired product if this interdependency is understood. Inlet process air temperature is determined by the choice of binder vehicle, whether aqueous or organic, and the heat sensitivity of the product being agglomerated. Generally, aqueous vehicles will enable the use of temperatures between 60°C and 100°C. On the other hand organic vehicles will require the use of temperatures from 50°C to below room temperature. Higher temperatures will produce rapid evaporation of the binder solution and will produce smaller, friable granules. On the other hand, lower temperatures will produce larger, fluffy, and denser granules.

Figure 24 shows the relationship of inlet and product air temperature, and outlet air humidity during the granulation process.

The process of drying while applying spraying solution is a critical unit operation. This mass transfer step was previously discussed. The temperature, humidity, and volume of the process air determine the drying capacity. If the drying capacity of the air is fixed from one batch to the next, then the spray rate can also be fixed. If the drying capacity of the air is too high, the binder solution will have a tendency to spray dry before it can effectively form bridges between the primary particles. If on the other hand, the drying capacity of the air is too low, the bed moisture level will become too high and particle growth may become uncontrollable. This will result in unacceptable movement of the product bed.

As previously discussed, the appropriate process air volume, inlet air temperature, and binder spray rate are critical for achieving proper and consistent particle size distribution and granule characteristics. There are many ways to arrive at the proper operating parameters. The following procedure was found by the authors to be one of the ways one can set the operating parameters when granulating with fluid bed processors.

1. Determine the proper volume of air, to achieve adequate mixing and particle movement in the bowl. Avoid excessive volumetric airflow so as to entrain the particles into the filters.
2. Choose an inlet air temperature that is high enough to negate weather effects (outside air humidity or inside room conditions). The air temperature should not be detrimental to the product being granulated. (To



**Figure 24** Temperature and humidity changes during the granulation process.

achieve consistent process year round, a dehumidification/humidification system is necessary, which provides the process air with constant dew point, and hence constant drying capacity).

3. Achieve a binder solution spray rate that will not dry while spraying (spray drying) and will not overwet the bed. This rate should also allow the nozzle to atomize the binder solution to the required droplet size.
4. As stated earlier, a typical air velocity used for spray granulation is from 1.0 to 2.0 m/sec. Table 2, which is based on the psychrometric chart, gives a first guess at determining the proper spray rate for a spray granulation process in a fluid bed processor.

The presence of variables in the fluid bed granulation process, and their impact on the final granulation, was summarized by Davies and Gloor (102), where they state that the physical properties of granulation are dependent on both the individual formulations and the various operational variables associated with the process. The solution spray rate increase and subsequent increase in average granule size, resulted in a less friable granulation, a higher bulk density, and a better flow property for a lactose/corn starch granulation. Similar results were obtained by an enhanced binder solution, decreasing nozzle air pressure, or lowering the inlet air temperature during the granulation cycle. The position of the binary nozzle with respect to the fluidized powders was also studied. It was concluded that by lowering the nozzle, binder efficiency is enhanced, resulting in average granule size and a corresponding decrease in granule friability.



**Table 2** Calculation of Fluid Bed Spray Rate

---

Given process data

Air volume range:

Minimum (1.2 m/sec) \_\_\_\_\_ m<sup>3</sup>/hr

Maximum (1.8 m/sec) \_\_\_\_\_ m<sup>3</sup>/hr

Inlet air temperature and humidity to be used: \_\_\_\_\_ °C \_\_\_\_\_ %RH

% Solids in sprayed solution: \_\_\_\_\_ % solids

From psychrometry chart

Air density at point where air volume is measured: \_\_\_\_\_ m<sup>3</sup>/kg air

Inlet air absolute humidity (H): \_\_\_\_\_ g H<sub>2</sub>O/kg air

Maximum outlet air absolute humidity (H): \_\_\_\_\_ g H<sub>2</sub>O/kg air

(Follow line of constant adiabatic conditions)

Use 100% outlet RH for spray granulator or 30–60% RH (as required for column coating)

Calculations for spray rate

Step 1 Convert air volumetric rate to air mass rate

Minimum \_\_\_\_\_ m<sup>3</sup>/hr ÷ (60 × \_\_\_\_\_ m<sup>3</sup>/kg air) = \_\_\_\_\_ kg air/min

Maximum \_\_\_\_\_ m<sup>3</sup>/hr ÷ (60 × \_\_\_\_\_ m<sup>3</sup>/kg air) = \_\_\_\_\_ kg air/min

Step 2 Subtract inlet air humidity from outlet air humidity

\_\_\_\_\_ (g H<sub>2</sub>O/kg air) H<sub>out</sub> - \_\_\_\_\_ (g H<sub>2</sub>O/kg air) H<sub>in</sub>

= \_\_\_\_\_ g H<sub>2</sub>O removed/kg air

Step 3 Calculate (minimum and maximum) spray rate of solution

This will provide range of generally acceptable spray rates based on the airflow used in the unit

Step 1 (minimum) \_\_\_\_\_ × step 2 \_\_\_\_\_ ÷ [1 - ( \_\_\_\_\_ % solids ÷ 100)]

= \_\_\_\_\_ spray rate (g/min) at minimum airflow

Step 2 (maximum) \_\_\_\_\_ × step 2 \_\_\_\_\_ ÷ [1 - ( \_\_\_\_\_ % solids ÷ 100)]

= \_\_\_\_\_ spray rate (g/min) at minimum airflow

---

The significant process parameters and their effect on the granule properties are summarized in [Table 3](#).

Maroglou (43) listed various parameters affecting the type and rate of growth in batch fluidized granulation ([Table 4](#)) and showed the influence of process parameters and the material parameters on the product.

## 7. PROCESS CONTROLS AND AUTOMATION

The agglomeration process is a batch process, and accurate repeatable control of all critical process parameters is necessary for a robust system. Earlier designs of the fluid bed processor used pneumatic control, which provided safe operation in a hazardous area but relied heavily on human actions to achieve repeatable product quality and accurate data acquisition. Current designs use PLCs and personal computers (PCs) to achieve sophisticated control and data acquisition. The operating conditions are controlled to satisfy parameters of multiple user-configured recipes, and critical data are collected at selected time intervals for inclusion in an end-of-batch report. Security levels protect access to all user-configured data with passwords permitting access only to selected functions. With the appropriate security level, not only are operating conditions configured, but also identification of each

**Table 3** Significant Variables and Their Impact on the Fluid Bed Granulation Process

Process parameter	Impact on process	References
Inlet air temperature	Higher inlet temperature produces finer granules and lower temperature produces larger stronger granules	(74,85)
Humidity	Increase in air humidity causes larger granule size, longer drying times	(39)
Fluidizing airflow	Proper airflow should fluidize the bed without clogging the filters. Higher airflow will cause attrition and rapid evaporation, generating smaller granules and fines	(17,20,74)
Nozzle and position	A binary nozzle produces the finest droplets and is preferred. The size of the orifice has an insignificant effect, except when binder suspensions are to be sprayed. Optimum nozzle height should cover the bed surface. Too close to the bed will wet the bed faster producing larger granules, while too high a position will spray dry the binder, create finer granules, and increase granulation time.	(59)
Atomization air volume and pressure	Liquid is atomized by the compressed air. This mass-to-liquid ratio must be kept constant to control the droplet size and hence the granule size. Higher liquid flow rate will produce larger droplet and larger granule and the reverse will produce smaller granules. At a given pressure an increase in orifice size will increase droplet size	(39,59,87,94)
Binder spray rate	Droplet size is affected by liquid flow rate, and binder viscosity and atomizing air pressure and volume. The finer the droplet, the smaller the resulting average granules	(17,56,73,74,94)

valid recipe and operator is entered. The identification is verified before any operator actions are permitted and is included with the end-of-run report. The use of computer related hardware requires some additional validation, but with coordination between the control system provider and the end user, the validation of software can be managed. [Figure 25](#) shows the pneumatic control panel and [Fig. 26\(A\)](#) and [\(B\)](#) shows a PLC-based control panel with a typical operator screen.

The most important sensors for control of the drying process are product, inlet and exhaust air temperature, and sensor for airflow measurement, located in the air transport system. Other sensors for the spray agglomeration process are atomization air pressure and volume, pressure drops (across the inlet filter; the product container with the product being processed, and outlet process air filter), inlet air humidity or dew point, process filter cleaning frequency and duration, spray rate for the binder solution, and total process time.

All of these sensors provide constant feedback information to the computer. These electronic signals may then be stored in the computer's memory and then recalled as a batch report. With this ability to recall data analysis, a greater insight can be gained into the process.

**Table 4** Influence of Operating and Material Parameters on the Granulated Product

<i>Operating parameters</i>	
Droplet size	NAR <sup>a</sup> Atomization air velocity Rheology Surface tension Nozzle position Nozzle type
Bed moisture content	Solution type and feed rate Bed temperature Fluidization velocity Aspect ratio Nozzle position and atomization velocity Air distributor design Jet grinding
Binder solution/suspension Concentration	Bridge strength and size Rheology
<i>Material parameters</i>	
Binder solution/suspension Concentration	Bridge strength and size Rheology
Type of binder	Molecular length and weight
Wettability	Particle-solvent interaction Surface tension Viscosity
Material to be granulated	Average particle size Size distribution <sup>a</sup> Shape and porosity Drying characteristics Density and density differences <sup>b</sup>

<sup>a</sup>NAR is the ratio of air to liquid flow rates through the nozzle of a twin fluid atomizer expressed either in mass units or in volume units (air at STP).

<sup>b</sup>Especially important relative to elutriation and segregation.

## 7.1. Advances in Process Control and Automation

The degree of the instrumentation of pharmaceutical unit operations has increased. This instrumentation provides information on the state of the process and can be used for both process control and research. A central part of optimizing production is increasing the level of automation. Besides monitoring the process parameters, a number of approaches are being developed for measuring the moisture of the product to determine the end point of the process, and consequently the in-process particle size analysis. A number of publications discuss the on-line moisture measurement and process end point determination using near-infrared (NIR).

### 7.1.1. Near-Infrared

The nondestructive character of vibrational spectroscopic techniques, such as NIR, makes them novel tools for in-line quality assurance (103). NIR has been widely used for the measurement of water in various applications (28). NIR can be applied both for quantitative analysis of water and for determining the state of water in solid material. This gives a tool for understanding the physicochemical phenomena during manufacture of pharmaceutical granulation.

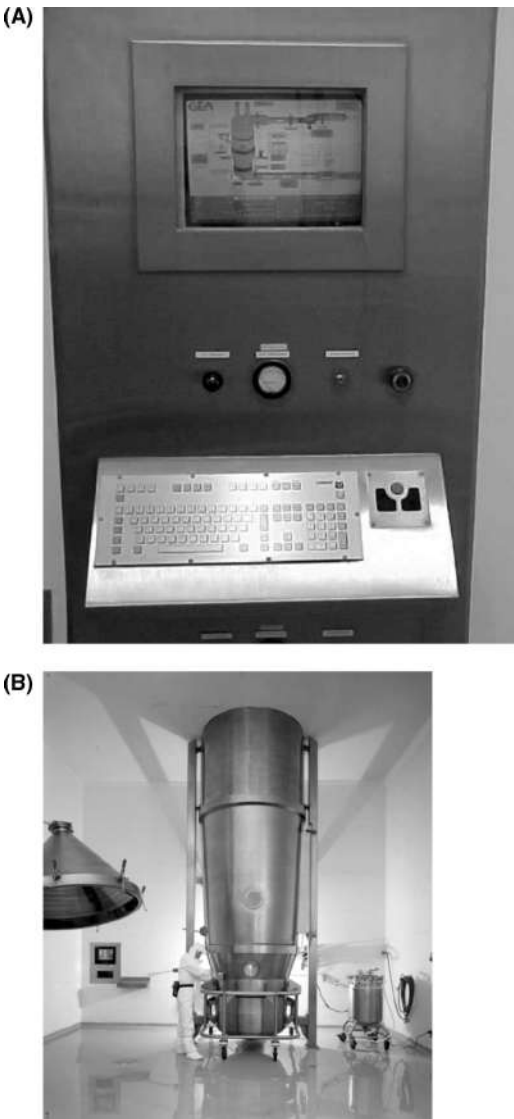


**Figure 25** Pneumatic control panel. (Courtesy of the Glatt Group.)

The history of NIR dates back to the studies, by Herschel, in 1800. The modern NIR analysis was developed in 1950 by the works of a group at United States Department of Agriculture (USDA), headed by Karl Norris (28).

Other branches of chemical industry have also applied for various applications. One feature of NIR is that the applications have been ahead of theoretical aspects. This has hindered the general approval of NIR in the pharmaceutical industry. However, the pharmacopoeias have defined some characteristics of analysis with NIR (104,105). The NIR spectrum is just above the visible region of electromagnetic spectrum (EMS). The NIR region covers the interval between 4000 and 12,500  $\text{cm}^{-1}$  (0.8–2.5  $\mu\text{m}$ ). Molecules that absorb NIR energy vibrate in two fundamental modes: stretching and bending. Stretching is a continuous change in the interatomic distance, along the axis between two atoms, and it occurs at lower wavelengths than bending vibration. A bending vibration is a change in the bond angle between diatomic molecules. A band observed at 1940 nm is known to be caused by O–H stretching and bending vibrations, and is the most used analytically (106,107). It has recently been reported, from measurements on silica gel layers, that water content has an effect on NIR absorption at all wavelengths, even where water is absorbed minimally (108). Usually, for a solid sample, the reflected light is the parameter measured in NIR spectroscopy, known as diffuse reflectance. The reflected light consists of two components: specular and diffuse. The specular, or mirror-like, component in the boundary between two media occurs at the sample surface, and it contains little information about the chemical composition of the substance. The NIR spectroscopy is particularly based on the diffused component of the reflected light, and it can be affected by particle size and shape distribution, bulk density surface characteristics, and temperature (109,110). This portion of the Electro Magnetic Spectrum (EMS) has, for the last 30 years, been studied and investigated in great detail as an analytical tool for the analysis of many natural and man-made materials (109,111–114).

Developing a functional automation system requires new measuring techniques; new in-line measuring devices are needed (115–119). Solid–water interactions are one of the fundamental issues in the pharmaceutical technology. The state of



**Figure 26** (A) PLC based system. (Courtesy of Niro Pharma Systems.) (B) Production unit with a PLC control panel. (Courtesy of the L.B. Bohle Group.)

water in the solid material may be characterized using x-ray diffraction, microscopic methods, thermal analysis, vibrational spectroscopy, and nuclear magnetic resonance spectroscopy (120). Traditionally, the control of fluidized bed granulation has been based on indirect measurements. These control methods applied utilize the properties of process air by Schaefer and Worts (47). Frake et al. (121) demonstrated the use of NIR for in-line analysis of the moisture content in 0.05–0.07 mm pellets during spray granulation in fluid bed processor. Rantanen et al. (122,123) described a similar approach for moisture content measurement using a rationing of three to four selected wavelengths. He and his coworkers reported that the critical part of in-line process was the sight glass for probe positioning, which was continuously

blown with heated air. They also reported spectra baselines caused by particle size and refractive properties of the in-line samples; they analyzed several data pretreatments to eliminate these effects on their fixed wavelength setup. Solvents other than water have also been evaluated for real-time quantification.

On-line measurement has also been possible enabling the monitoring of film coating on pharmaceutical pellets, in an industrial manufacturing process. Andersson et al. (124) conducted measurements on solid coated tablets using fiber-optic probe positioned in the fluid bed processor. In this case, they secured a representative sampling during processing, by using a sample collector that was emptied with compressed air inside the processor. Vázquez recently provided comprehensive review of FT-NIR application in measuring fluid bed drying end (125). Rantanen et al. (126) used NIR to monitor the moisture as well as airflow. Using in-line multichannel NIR the multivariate process data collected were analyzed using principal component analysis (PCA). The authors showed that robust process control and measurement system combined with reliable historical data storage can be used for analyzing the fluid bed granulation process. PCA modeling proved a promising tool to handle multidimensional data that were collected, and for reduction of the dimensionality of process data. FT-NIR spectra gave useful information for understanding the phenomenon during granulation. Rantanen et al. (127) further studied the application of NIR for fluid bed process analysis. The authors used NIR to study moisture measurement combined with temperature and humidity measurements. By controlling the water during the fluid bed granulation, the granulation process was controlled. They concluded that the varying behavior of formulations during processing can be identified in a real-time mode. Thus, they found that NIR spectroscopy offered unique information of granule moisture content during all phases of granulation.

### *7.1.2. Other Approaches for Process Control*

**7.1.2.1. Self-Organizing Maps.** On-line process data are usually multidimensional, and it is difficult to study with traditional trends and scatter plots. Rantanen et al. (128) has suggested a new tool called “self-organizing maps” (SOM), for dimension reduction and process state monitoring. As a batch process, granulation traversed through a number of process states, which was visualized by SOM as a two-dimensional map. In addition, they demonstrated how the differences between granulation batches can be studied.

**7.1.2.2. At-Line Measurement.** Laitinen et al. presented a paper at a recent conference (129) proposing at-line optical techniques to study particle size. Using a CCD camera with optics and illumination units, with stabilized collimated light beams, authors took two images of 36 granule samples by illuminating the samples alternatively. Two digital images, with matrices of their gray scale values, were obtained and the differences between the two matrices were calculated. This method provided very rapid (1 min per sample) measurement of particle size, with a very small sample size (<0.5 g).

**7.1.2.3. Focused Beam Reflectance Measurement.** This device uses a focused beam of laser light that scans, in a circular path, across a particle or particle structure passing in front of the window. Upon hitting the particle, light is scattered in all directions. The light scattered back toward the probe is used to measure the chord length or the length between any two points on a particle. Such devices are supplied commercially and claim to be useful for monitoring on-line measurement of particle size in the fluid bed granulation process.

**7.1.2.4. Artificial Neural Network.** Neural networks have been used by scientists for optimizing formulations as an alternative to statistical analysis because of its simplicity for use and potential to provide detailed information. The neural network builds a model of the data space, which can be consulted to ask “what if” kinds of questions. Recently, there has been interest in using artificial neural network (ANN) for process control. Similar to the human brain, an ANN predicts events or information based on learned pattern recognition. ANNs are computer systems developed to mimic the operations of the human brain, by mathematically modeling its neurophysiological structure (i.e., its nerve cells and the network of interconnections between them). In ANN, the nerve cells are replaced by computational units called neurons, and the strengths of the interconnections are represented by weights (130). This unique arrangement can simulate some of the neurolocal processing ability of the brain, such as learning and drawing conclusions from experience (131). Using the process control system, quality assurance results, or energy usage data, an ANN develops supervisory set points for the system. When ANN and process control systems are used together, they form a product control system. Product control occurs when a system measures defined product attributes in real time, and uses the knowledge to adjust the control system. While process control system runs the process (i.e., fans, motors, heaters, etc.), the ANN controls the product (moisture level, consistency). The fluidized bed processor’s process control system includes an operator interface, sensing elements, and final control elements. The inputs in that case are inlet air temperature, outlet air temperature, airflow rate, and energy consumption. Additional contributing factors are the fouling coefficient of the dryer bags, the quantity of product in the processor, and the type of product with its unique characteristics.

Watano et al. (132) described a practical method for moisture control in fluid bed granulation by means of neural network. Wet granulation of pharmaceutical powder was conducted using an agitation fluidized bed, and the moisture content was continuously measured by IR moisture sensor. A neural network system for moisture control was developed using moisture content and its changing rate as input variables, and the moisture control characteristics were investigated by the neural network system with a back propagation learning. Good response and stability without overshoot were achieved by adopting the developed systems. This system also maintained favorable stability under various operating conditions. Several researchers have published papers, detailing the use of ANN for different applications (133–135).

## **8. PROCESS SCALE-UP**

### **8.1. Regulatory**

Scale-up is normally identified with an incremental increase in batch size, until a desired level of production is obtained. In 1991, American Association of Pharmaceutical Scientists (AAPS) with US FDA held a workshop on scale-up (136), where several speakers presented scale-up issues from an industrial and regulatory perspective. For example, Shangraw divided scale-up problems into two general categories: those related to raw materials or formulation and those related to processing equipment. He also indicated that it is essential to ascertain whether or not changes in raw materials have occurred, before one looks at processing/equipment changes as a source of any problem. The workshop report, as it pertains to the process and equipment, is reproduced below:

It is generally recognized that many NDAs and ANDAs contain provision for multiple manufacturers of the drug substance(s), and that not all drug substance suppliers, a priori, produce equivalent material. There is then a need for material quality control to assure the performance and reproducibility of the finished product. Particle size and distribution, morphology, and intrinsic dissolution of the drug substance are important considerations. Polymorphism, hygroscopicity, surface area, wettability, density (bulk and tapped), compressibility (for dry blending), and powder flow effects should be controlled.

Additionally, the process should be controlled by employment of a validation protocol, which defines the critical parameters and also establishes the acceptance criteria for the granulation or blend; which may include sieve analysis, flow, density, uniformity, and compressibility, moisture content, etc.

In the milling, blending, granulating and or drying processes, the operating principles of the equipment employed should be defined, and the variables determined. The impact and mechanism of measurement on in-process variables should be defined. Time, temperature, work input of equipment, blend/granulation volume, and granulating rate should be determined. . . . The parameters selected should be appropriate for the process, . . . In those cases where the manufacturing process has been controlled and validated as specified in the foregoing discussion; batch scale-up, changes in site of manufacture, allowance for equipment change (where the operating principle is the same), minor formulation changes, etc., should be determined on the basis of the comparability of both the blend/granulation and the final product; as assured by: a) appropriate tests; b) specifications; c) process validation; and d) comparative accelerated stability.

Regulatory guidelines for scale-up and postapproval changes (SUPAC) IR were released in 1995 (137) and are discussed in another chapter of this book.

## 8.2. Scale-Up and Equipment Design

The scale-up from the laboratory equipment to production size units is dependent on equipment design, which may or may not have been scalable as far as its dimensional feature or components selection is concerned. The importance of scalability is well understood and accepted by the manufacturers of fluid bed processors. Various sizes in their product line are logically designated and manufactured. Airflow in the fluid bed process is a critical parameter. The design and selection of the processor is very important for the laboratory and production unit. Because airflow is one of the components of the drying capacity of a fluid bed system, the ratio of air volume per kilogram or liter of the product is very critical to achieve a scale-up that is linear. The other design feature is the cross-sectional area of the product container, and how it has been designed throughout the various sizes that a manufacturer supplies. The relationship between various sizes of the process containers can be utilized to calculate the scale-up of binder spray rate, and if the cross-sectional area is designed linearly, then the spray rate scale-up can be linear.

## 8.3. Scale-Up and Process Factors

The fluid bed agglomeration process is a combination of three steps, namely, dry mixing, spray agglomeration, and drying to a desired moisture level. These process steps are equally important. But the quality of the granules is really determined during the spraying stage, when constant building of granules and evaporation of



binder solvent are taking place. Granule size is directly proportional to the bed humidity during granulation (47) and hence, control of this humidity during scale-up is essential.

Gore et al. (138) studied the factors affecting the fluid bed process during scale up. The authors found that processing factors that affected granule characteristics the most, were process air temperature, height of the spray nozzle from the bed, rate of binder addition, and the degree of atomization of the binder liquid.

The atomizing air pressure and the wetness of the bed are two of the most important elements of fluid bed granulation. A higher atomizing air pressure yields a finer droplet of binder solution. Therefore, granule growth (as described earlier in this section) is affected by the atomizing air pressure. A major factor which must be considered during the scale up of fluid bed granulation process is maintaining the same droplet size of the binder for assuring successful scale-up. A recent study (139) confirmed the influence of spray nozzle setup parameters on the drying capacity of the air. The study concluded that more attention should be paid to the easily overlooked nozzle atomizing air pressure and volume. When considering the atomizing air pressure, attention must be paid to ensure that enough air is delivered to the nozzle tip. This can be ensured by placing air pressure and volume measurement devices at the nozzle. The data also show that the drying capacity of the process air influences the final granulated particle size.

Jones (140) has suggested various process related factors that should be considered during the scale-up of a fluid bed processing. The suggestions are listed in the following paragraphs.

Due to the higher degree of attrition in the larger unit compared to the smaller unit, the bulk density of the granulation from the larger fluid bed is  $\approx 20\%$  higher than the smaller unit. He also re-emphasized the importance of keeping the bed moisture level below the critical moisture level, to prevent the formation of larger agglomerates. Since the higher airflow along with the temperature (drying capacity) in a larger unit provide higher evaporation rate, one must maintain the drying capacity in the larger unit, such that the bed temperature is similar to the smaller-unit bed temperature. This can be accomplished, either by increased spray rate, increased air temperature, and increased airflow, or by the combination of these variables to obtain suitable results. Since the ratio of bed depth to the air distributor increases with the size of the equipment, the fluidization air velocity is kept constant by increasing the air volume. In the past, the scale-up was carried out by selecting best guess process parameters. The recent trend is to employ the factorial and modified factorial designs and search methods. These statistically designed experimental plans can generate mathematical relationships between the independent variables, such as process factors, and dependent variables, such as product properties. This approach still requires an effective laboratory/pilot scale development program and an understanding of the variables that affect the product properties.

In summary, when scaling up, the following processing conditions should be similar to the pilot scale studies:

1. Fluidization velocity of the process air through the system
2. The ratio of granulation spray rate to drying capacity of fluidization air volume
3. Droplet size of the binder spray liquid.

Each of these values must be calculated based on the results of the operation of the pilot size unit. Pilot size equipment studies should also be conducted in a wide range to determine the allowable operating range for the process.

Another chapter of this book provides fluidized bed scale-up and should be reviewed.

## 8.4. Case Study

The following case study illustrates how a product is scaled up from 15 to 150 kg in the equipment supplied by Aeromatic, when one understands the critical process parameters used when scaling up.

A spray granulation process was developed for a common pharmaceutical compound. The granulation process involved spraying of a 5% w/w binder solution onto the fluidized powder. Table 5 shows the data from the 15 kg run and the resulting successful 150 kg run condition for a spray agglomeration process.

### 8.4.1. Airflow Calculations

To maintain the same fluidization velocity, the air volume in a larger unit must be increased, based on the cross-sectional area of the product bowl. In this case, the cross-sectional area of the base of the larger container was  $0.77 \text{ m}^2$  and that of the smaller was  $0.06 \text{ m}^2$ . The correct airflow should be calculated as  $300 \times (0.77/0.06) = 3850 \text{ CMH}$ . This number was further modified after considering the increase in bed depth in a larger unit to 4000 CMH.

### 8.4.2. Spray Rate Calculations

To maintain the same particle size, the triple-headed nozzle could spray three times the pilot unit spray rate at a 2.5 atomization air pressure. However, this could result in a longer process time. Another approach to maintain a similar droplet size is to maintain the mass balance of spray rate and the atomization pressure. Thus, by increasing the atomization pressure to 5 bar, the spray rate was increased to 800 g/min, keeping the same droplet size, and hence obtaining granulation with the desired characteristics.

### 8.4.3. Temperature Calculations

Finally, the required inlet temperature was recalculated based on the change in the ratio of the air volume to the spray rate. Because the air volume was increased over 13 times but the spray rate was only increased eight times, the inlet temperature was reduced to  $50^\circ\text{C}$ . This adjustment in drying capacity was necessary to avoid spray drying of the spray solution. (A three-headed nozzle used in this scale-up can be

**Table 5** Scale-Up Process Parameters from a 15 to a 150 kg Batch

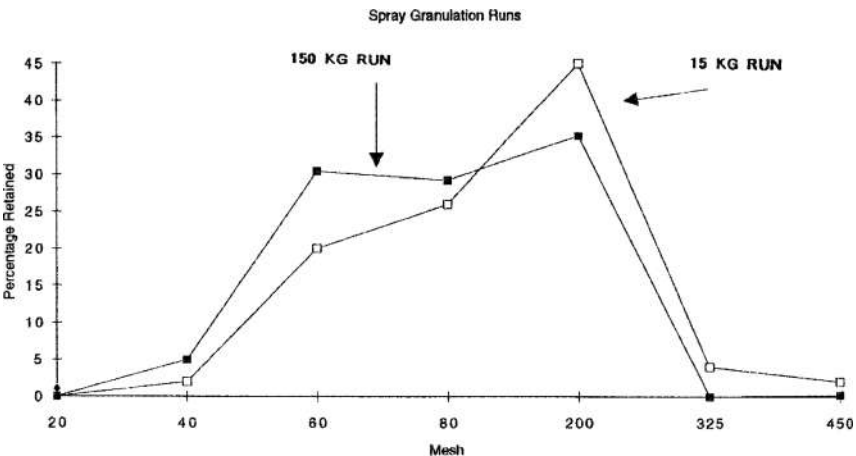
Process parameters	15 kg	150 kg
Airflow ( $\text{m}^3/\text{hr}$ )	300	4000
Inlet air temperature ( $^\circ\text{C}$ )	55	50
Spray rate (g/min)	100	800
Nozzle air pressure (bar)	2.5	5
Container cross-sectional area of the base ( $\text{m}^2$ )	0.06	0.77
Number of nozzles	1	3

replaced by a six-headed nozzle. This would have resulted in the ability to increase the spraying rate 13 times above the pilot size unit to match the airflow. The maintenance of droplet size and temperature could have been achieved with the six-headed nozzle. The end result would be reduced process time.) Figure 27 shows the particle size distribution produced, using 15 and 150 kg units.

Recently, Matharu and Patel (141) presented a scale-up case study, where a low-dose multiple-strength product (0.5–5% w/w/ active) was spray granulated and scaled up from a pilot scale fluid bed processor to production size equipment. Their approach was based on matching air velocity between the two scales of operation. The impact of droplet size was determined by varying the independent parameters. Based on their study, authors have suggested an equation, which takes into account, material and equipment parameters. Rambali (142) scaled up granulation process from small (5 kg) to medium (30 kg) to large (120 kg) with an aim to obtain the target geometric mean granule size of 400 μm. The scaling up was based on the relative droplet size and the powder bed moisture content at the end of the spraying cycle. Authors found that the effect of the change in relative droplet size on the granule size was different for each fluid bed. They applied the experimental design on the small- and medium-scale unit, and regression models for the granule size were proposed in order to scale up the granulation process on the small to medium scale. Using only the relative droplet size, authors were able to scale up the process to the larger unit.

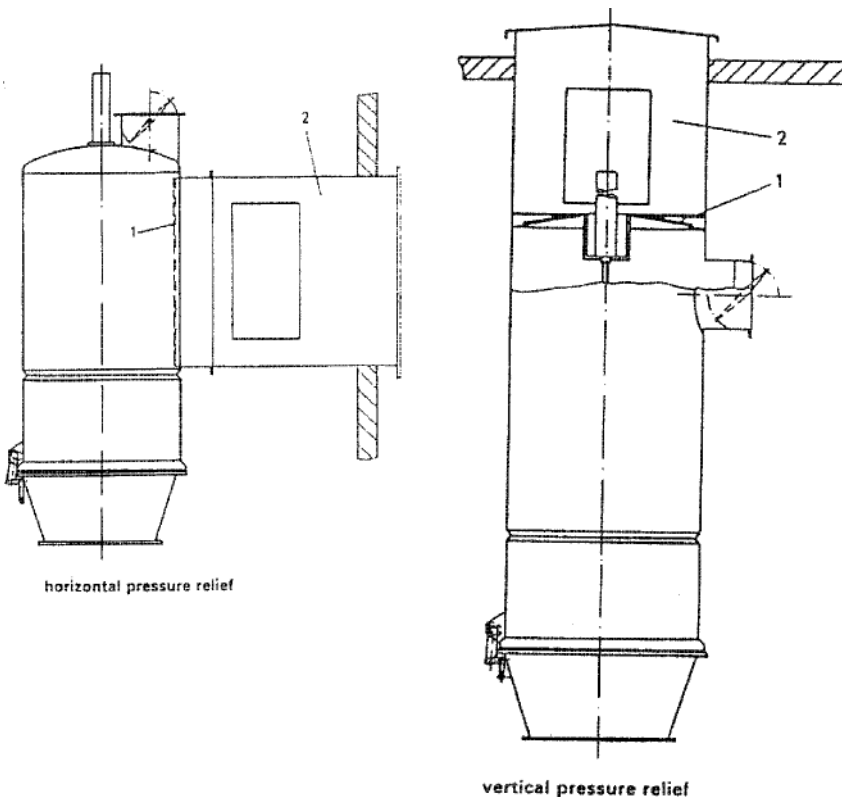
**9. SAFETY IN FLUID BED**

For an explosion to occur, three conditions must exist: an ignition source, a fuel, and oxygen. With an explosion, oxygen reacts with the fuel, releasing heat and gases. If a dust explosion occurs in free space, a fireball of considerable extent arises. If the dust explosion occurs in a closed container, there is a sudden pressure rise that is mainly decided by the following factors: type of dust, size of the dust, dust/oxygen ratio, turbulence, precompression, temperature, shape of the container, and ignition source. In a container without precompression and with an organic dust of sufficient fineness, the pressure inside the container can rise to over 10 bar overpressure.

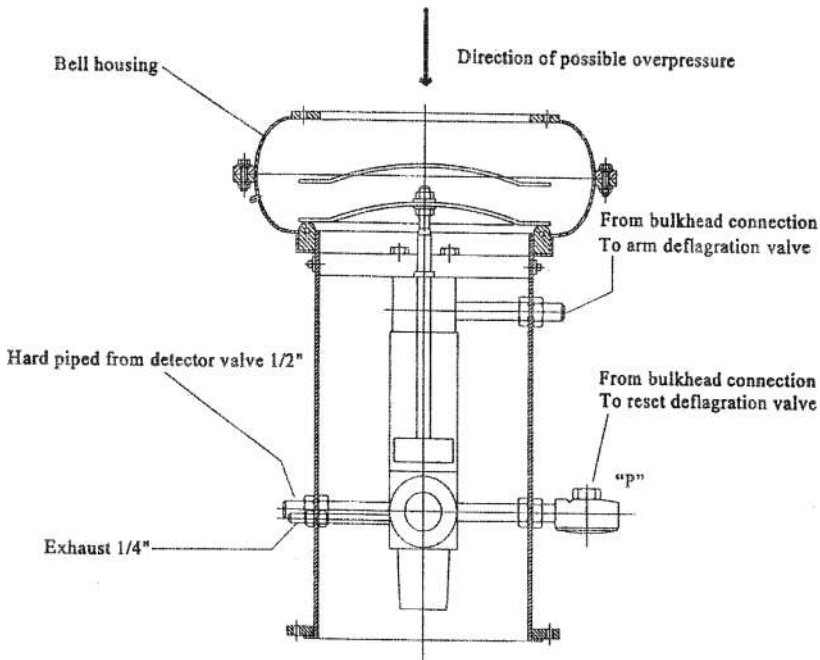


**Figure 27** Scale-up case study and resultant particle size distribution.

The fluid bed process handles a large amount of air. This air, in the presence of fine product dust, poses potential for an explosion. This hazard can be enhanced when using flammable solvents. If sufficient ignition energy (static charge) is introduced, an explosion within the processor can take place. In order to contain these dust or flammable solvent induced explosions, fluid bed processors are normally constructed to withstand an overpressure of 2.0 bar. In this case, the fluid beds are provided with explosion relief flaps, to release the pressure as soon as it starts to build up inside the processor. The explosion flaps, mounted either horizontally or vertically (Fig. 28), are designed to vent the pressure buildup as low as 0.06 bar. The explosion protection valve, shown in Figure 29, acts to cut off the airflow to the blower and isolates the overpressure within the processor. The 2 bar vented design shows the propagation of the overpressure (Fig. 30). The explosion flaps open up to the outside of the building. These panels are gasketed, and sealed so that normal fluid bed operation is not affected. It was an accepted practice to have the production unit with 2 bar pressure shock integrity; however, the cleaning of the gasket area around the flaps is always difficult. To avoid having the product exposed to the outside during such an event, a suppression system is used to contain the possible overpressure front from leaving the unit (Fig. 31). The suppression system consists of low-pressure sensors located within the processor. These sensors are designed to trigger a series of fire extinguishers (containing ammonium phosphate), as soon as a preset level (generally, 0.1 bar) of pressure is set within the processor.

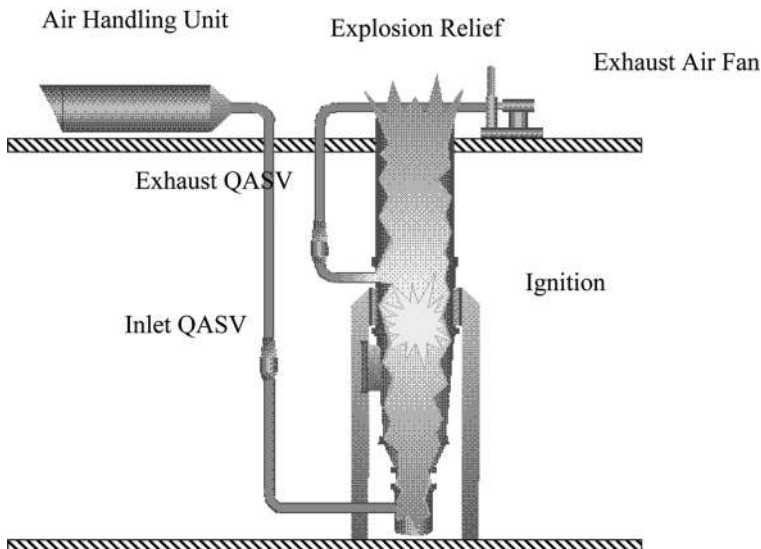


**Figure 28** Processor with horizontal and vertical relief.

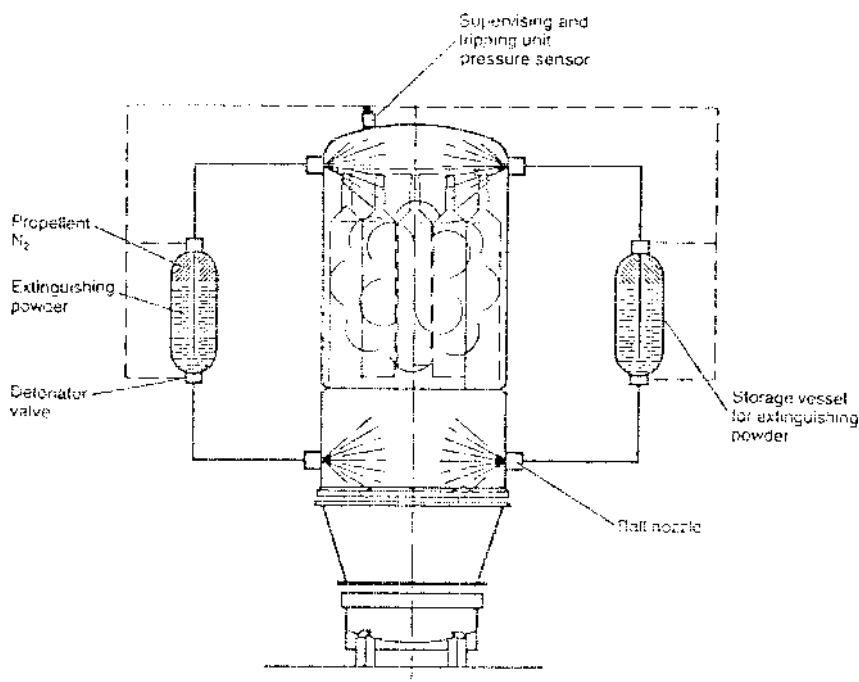


**Figure 29** Explosion protection valve.

With the introduction of potent and costly drug substances, the 2 bar design is being replaced with a 10 bar design and higher, based on the specific mixtures of the product(s) being processed. These units can withstand explosions up to 10 bar. Most of the pharmaceutical dust explosions studied (143) show the overpressure reaching



**Figure 30** Vented design (2 bar unit). (Courtesy of the Glatt Group.)



**Figure 31** Explosion suppression system.

9 bar, with a  $K_{st}$  value (constant of explosion speed) of 200. An explosion in a 10 bar unit is contained within the unit. A 10 bar designed unit does not require any explosion relief panels or gaskets. This eliminates the concerns about cleaning of the gaskets and panels. Another advantage of a 10 bar unit is that, in case of explosion, the processor containing the potent drug substance is contained inside the unit, and explosion does not pose an environmental problem as with the 2.0 bar unit. [Figure 32\(A\)](#) and [\(B\)](#) shows the Ventex-ESI valve for passive control of the explosion. The Ventex-ESI valve requires less maintenance than the active valve shown in [Figure 29](#). An explosion force (pressure wave), moving ahead of the flame front, hurls the poppet forward to the valve seat providing an airtight seal. The poppet, once seated, is locked in by a mechanical shut-off device, which retains the seal until manually reset. The three basic versions of the standard mechanical Ventex valve are available with a set pressure of 1.5 psi and a maximum pressure of 150 psi. The Ventex-ESI valve closes by the explosion pressure wave, without external power for horizontal or vertical operation. [Figure 33](#) shows the various types of Ventex valves installed in a fluid bed system.

In case of granulation requiring flammable solvents, process air and nozzle atomization air are replaced by an inert gas such as nitrogen and the system is designed as a closed cycle with a solvent recovery capability (144). A number of approaches can be taken to handle solvent from the process. [Table 6](#) summarizes various methods for solvent emission control systems.

Külling and Simon (18) reported the closed loop system shown in [Figure 34](#). The inert gas used for fluidization circulates continuously. An adjustable volume of gas is diverted through the bypassed duct, where solvent vapors are condensed and solvent collected. The circulating gas passes through the heat exchanger to maintain the temperature necessary for evaporation of the solvent from the product bed. During

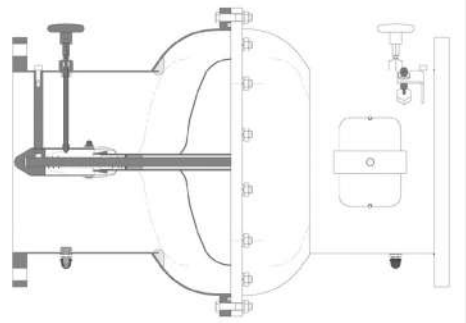
(A) **Rico-Sicherheitstechnik AG**  
 St.Gallerstrasse 26  
 CH-9100 Herisau



Explosionbarrier valve Ventex-ESI-E passiv,  $K < 300$  (400)  $\text{bar} \cdot \text{m} \cdot \text{s}^{-1}$

**Function:**

- Valve poppet positioned between two springs in the valve housing
- Pressure wave of the explosion pushes valve poppet into the closed and locked position
- Flame and pressure barrier between valve poppet and housing with an elastomer gasket
- Position of valve poppet indicated by a mechanical indicator or by a limit switch



**Ventex-ESI-E**

(B)



**Figure 32** (A) Schematic of the Ventex valve. (B) Ventex valve. (Courtesy of Rico-Sicherheitstechnik AG, Switzerland.)

the agglomeration and subsequent drying process, the solvent load in the gas stream does vary. The bypass valve controls the flow of the gas to the heat exchanger and the condenser. By controlling the gas stream in this manner, the drying action is continued until the desired level of drying is reached. Even though the cost of fluid bed processor with the solvent recovery is generally double the cost of a regular single-pass fluid bed processor, such a system offers effective measures for both explosion hazard reduction and air pollution control.

In 1994 European parliament issued the ATEX directive (145) on the approximation of the laws of the member states, concerning equipment and protective systems intended for use in potentially explosive atmospheres. The scope, these regulations specifically require “protective systems,” intended to halt incipient explosions immediately

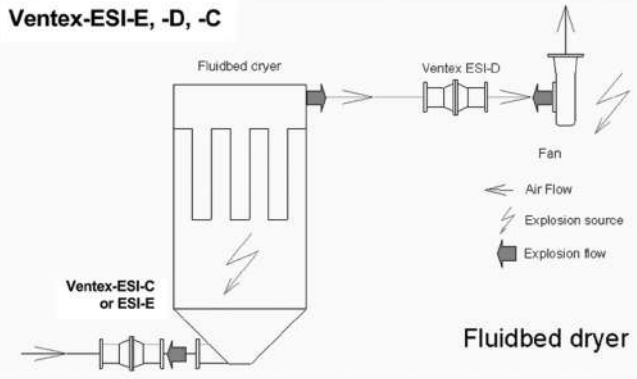
**Rico-Sicherheitstechnik AG**  
 St.Gallerstrasse 26  
 CH-9100 Herisau



Example of a Ventex-ESI-E/-D/-C installation in a fluidbed dryer

**Function:**

Fluidbed dryer, fan and dryer protected by a Explosionbarrier valve Ventex-ESI-D valve, inlet devices protected by a Ventex-ESI-C or a Ventex-ESI-E



**Figure 33** Setup of fluid bed with different Ventex valves. (Courtesy of Rico-Sicherheitstechnik AG, Switzerland.)

and to limit the effective range of explosion flames and explosion pressures. All manufacturers of fluid bed processors in Europe must comply with this directive.

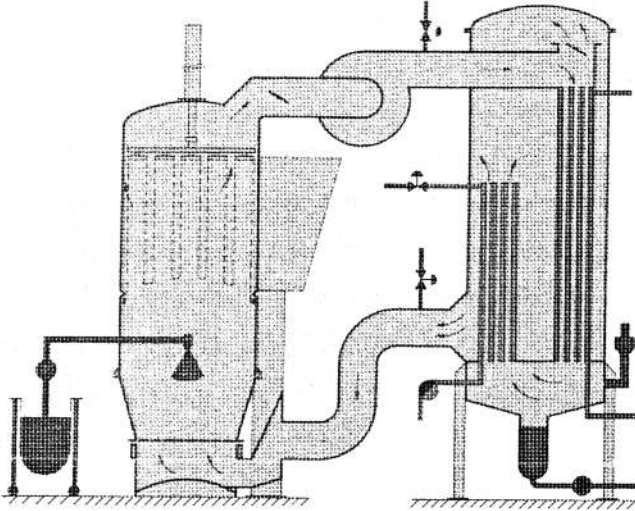
**10. MATERIAL HANDLING OPTIONS**

The transfer of materials to and from the fluid bed processor is an important consideration. The loading and unloading of the processing bowl can be accomplished either by manual mode or by automated methods.

**Table 6** Comparison of Different Solvent Emission Control System

Water scrubbing	Catalytic burning	Carbon absorption	Condensation
Open cycle	Open cycle	Open cycle	Closed cycle with nitrogen
High capital cost	Low capital cost	Moderate capital cost	Low capital cost
High energy requirement	Low energy	Low energy	Low energy
External installation	External installation	External installation	Internal installation
Medium space requirement	High space requirement	Moderate space requirement	Small space requirement
Medium flexibility	Medium flexibility	Low flexibility	Good flexibility
Waste treatment required	CO <sub>2</sub> /H <sub>2</sub> O emission waste treatment	Waste treatment	Concentrated waste treatment





**Figure 34** Schematic of closed loop solvent recovery system.

### 10.1. Loading

The contemporary method for loading the unit is by removing the product bowl from the unit, charging the material into the bowl, and then placing the bowl back into the unit. This loading is simple and cost-effective. Unfortunately, it has the potential of exposing the operators to the product and contaminating the working area. To avoid the product from having a dust and cleaning hazard, a dust collection system should be installed to collect the dust before it spreads. A manual process also depends on the batch size, the operator's physical ability to handle the material, and the container full of product. Furthermore, this can be time consuming, since the material must be added to the product container, one material at a time.

The loading process can be automated and isolated to avoid worker exposure, minimize dust generation, and reduce loading time. There are two main types of loading systems. These systems are similar because both use the fluid bed's capability to create a vacuum inside the unit. Here, the product enters the fluid bed through a product in-feed port, on the side of the unit. This is done by having the fan running and the inlet air control flap set, so that minimum airflow may pass through the product container and the outlet flap is almost fully open. Typically, when the high-shear granulated material needs to be charged into the fluid bed, this approach helps (Fig. 35). Once the material has been charged to the fluid bed, the product in-feed valve is closed and the granulating process started. This transfer method uses some amount of air to help the material move through the tube. Loading can be done either vertically from an overhead bin, or from the ground. Less air is required through the transfer pipe when the material is transferred vertically because gravity is working to help the process. Vertical transfer methods do require greater available height in the process area. Loading by this method has the advantages of limited operator exposure to the product, allows the product to be fluidized as it enters the processor, and reduces the loading time. The disadvantage of this type of system is the cleaning required between different products.



**Figure 35** Loading of fluid bed from high-shear mixer. (Courtesy of the Glatt Group.)

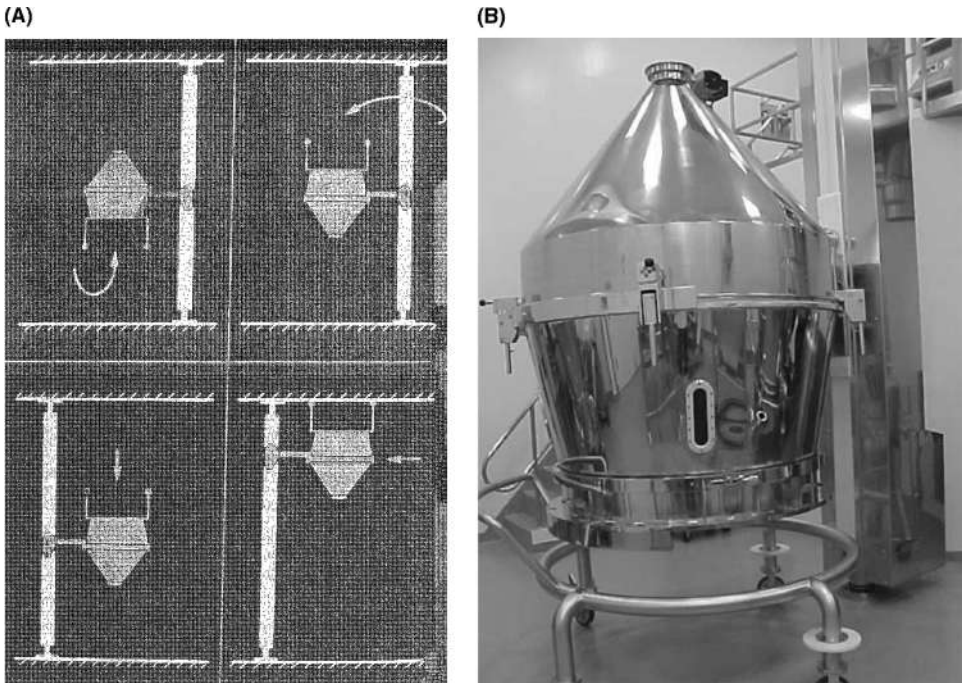
## 10.2. Unloading

As with loading, the standard method for unloading is by removing the product bowl from the unit. Once the bowl is removed, the operator may scoop the material from the bowl, which is the most time consuming and impractical method, because of its potential of exposure to the product. Alternatively, the product can be vacuum transferred to a secondary container or unloaded by placing the product bowl into bowl dumping discharge device, as shown in [Figure 36\(A\)](#) and (B).

This hydraulic device is installed in the processing area. The mobile product container of the fluid bed processor is pushed under the cone of the bowl dumper and coupled together by engaging the toggle locks. Subsequently, the container is lifted hydraulically, pivoted around the lifting column, and rotated 180° for discharging. Use of the bowl dumping device or vacuum unloading device still requires that the product bowl be removed from the unit. There are contained and automated methods for unloading the product, while the product bowl is still in the fluid bed processor. The product may be unloaded either from the bottom of the product container or from the side. Until recently, the most common contained method is to unload the material from the bottom of the unit. This requires a ceiling height high enough to accommodate it, or the installation becomes multistoried installation.

There are two types of bottom discharge options, gravity or pneumatic. Gravity discharge ([Figs. 37](#) and [38](#)) allows for collection of the product into container, which is located below the lower plenum. If the overall ceiling height limitation prevents discharge by gravity, the gravity/pneumatic transfer combination can be considered. The gravity discharge poses cleaning problems, since the process air and the product discharge follow the same path; assurance of cleanliness is always of prime concern.

The desire to limit the processing area and the development of the overlap gill air distributor mentioned earlier in the chapter has prompted the consideration of the side discharge as an option. The product bowl is fitted with the discharge gate, as shown in ([Fig. 39A](#) and B).



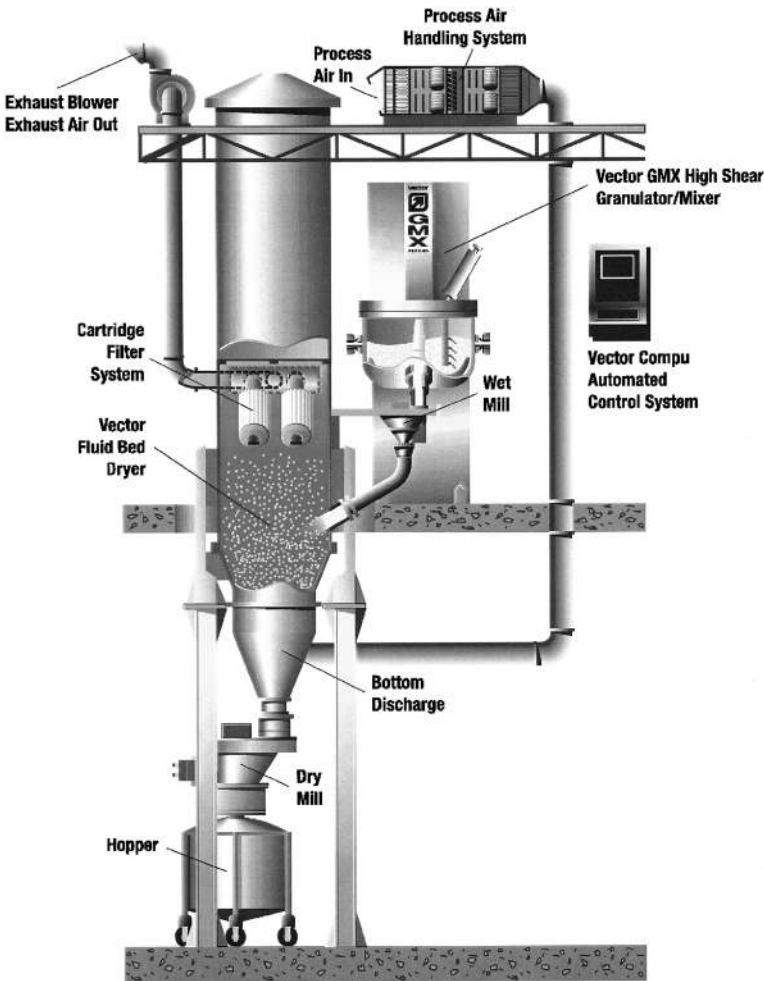
**Figure 36** (A) Product discharge system. (B) Bowl inverter. (Courtesy of Niro Pharma Systems.)

Most of the product, being free-flowing granules, flows through the side discharge into a container. The remainder of the product is then discharged by manipulation of the airflow through the overlap gill air distributor. The discharged product can be pneumatically transported to an overhead bin if the dry milling of the granulation is desired.

The contained system for unloading the product helps to isolate the operator from the product. The isolation feature also prevents the product from being contaminated due to exposure to the working environment. Material handling consideration must be thought of early in the equipment procurement process. Fluid bed processing, whether used as an integral part of high-shear mixer/fluid bed dryer or as a granulating equipment option, production efficiency, and eventual automation can be enhanced by considering these loading and unloading options.

## 11. FLUID BED TECHNOLOGY PROGRESS

The fluid bed processor was used as an efficient way to dry a product due to suspension of particles in the hot air stream. However, over the last 35 years, the development in the pharmaceutical industry and the proliferation of the batch fluid bed processing technology in other industries as food, polymer, detergent, etc., has provided the opportunity to use the batch fluid bed processor for granulation, coating of particles, and pelletization. The advances in the fluid bed can be attributed to several factors. The needs of formulators, the requirements of the regulators, and technological innovations from the manufacturers of these equipments are

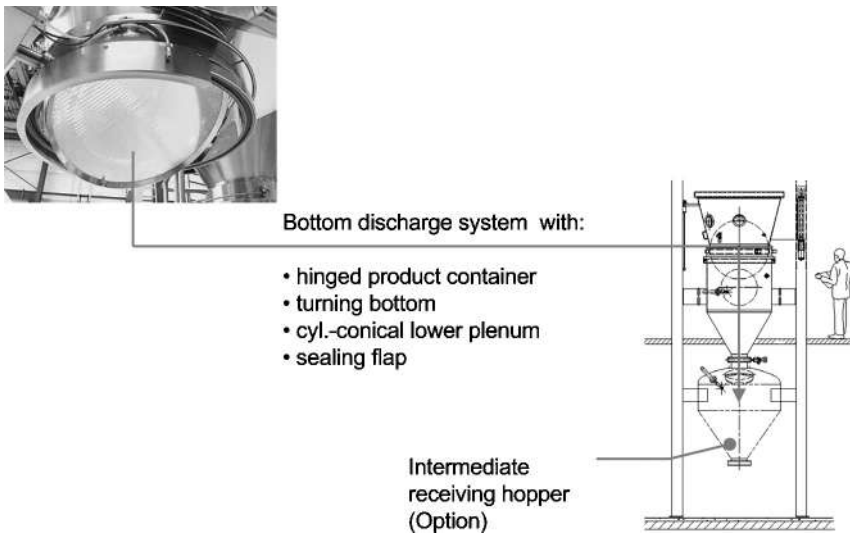


**Figure 37** Loading and unloading setup with bottom discharge. (Courtesy of the Vector Corporation.)

responsible for these advances. The result of these changes provided units that are paint free, modular, safer, in compliance with the cGMPs, and are capable of performing various processes that were not thought of before.

### 11.1. Developments in Equipment and Process Applications

Parikh (146) has presented a review of all of the equipment developments. Among various advances, the development of production units that can withstand more than 10 bar pressure shock resistance is a very significant development. These units do not require pressure relief duct and associated cleaning problems. Units are now equipped with the air handler that can provide designated humidity and dew point air, throughout the year and at any geographical location. The fluid bed CIP became a reality with the introduction of the overlap gill air distributors and the stainless steel cartridge filters described earlier in this chapter. The coating of the particles is carried out most frequently using Wurster column (Fig. 40A and B). The Wurster process is the most

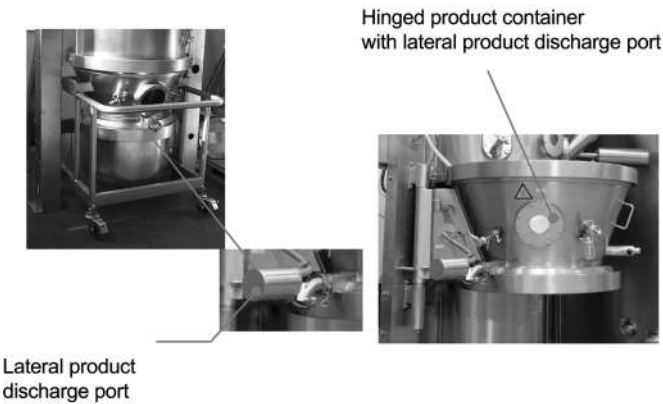


**Figure 38** Bottom discharge. (Courtesy of the Glatt Group.)

popular method for coating particles. The Wurster based coating process does not contain any fluid bed regions in the traditional sense, as it is a circulating fluid bed process. Four different regions within the equipment can be identified: the upbed region, the expansion chamber, the downbed region, and the horizontal transport region. The coating process consists of three phases: the start-up phase, the coating phase, and the drying and cooling phase. During the coating phase, several processes take place simultaneously. They are atomization of the coating solution or suspension, transport of the atomized droplets of the coating solution to the substrate, and drying of the film. In 1993, the design was modified as in Wurster HS (147).

However, the technology has certain disadvantages, such as nozzle accessibility, prolonged process time, minimum volume requirement, and difficulty of loading and unloading. In 1995, to address these shortcomings of the Wurster system, the Precision Coater<sup>®</sup> incorporating modified air suspension technique was introduced (148). It was designed to allow removal of the nozzles for cleaning, faster process time because of the patented particle accelerator, good utilization of thermal and kinetic energies, and scalability from a single-column to a multicolumn setup. Recently, Glatt organization introduced the STRATOS<sup>™</sup> system for applying sustained release tablet coating, using bottom spray. The modification of the bottom spray setup offers better efficiency than Wurster HS for coating tablets (149). The Wurster setup for granulating was presented by Walter et al. (150). Authors claim that the quality of granulation is superior to the top spray granulation.

Researchers have discussed the incorporation of microwave in the laboratory fluid bed processor (151,152). Fluid bed process using organic solvent requires an inert gas such as nitrogen to replace the air used for fluidization, as discussed earlier in the chapter. It is accompanied by the solvent recovery system. In 1989, a vacuum fluid bed system was presented by Luy et al. (153). The main feature was the generation and sustaining of a fluidized bed under vacuum, thereby eliminating the use of inert gas. Several advantages are claimed by the authors, such as emission reduction, increased recovery rate of solvent, and an application for oxygen sensitive materials.

**(A)** Side (lateral) discharge system**(B)**

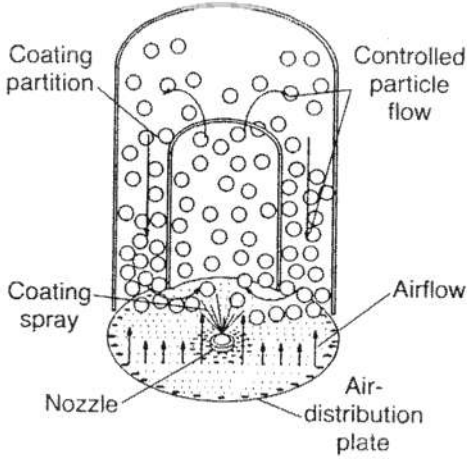
**Figure 39** (A) Side discharge. (Courtesy of the Glatt Group.) (B) Side discharge. (Courtesy of Niro Pharma Systems.)

## 11.2. Rotary Fluid Bed

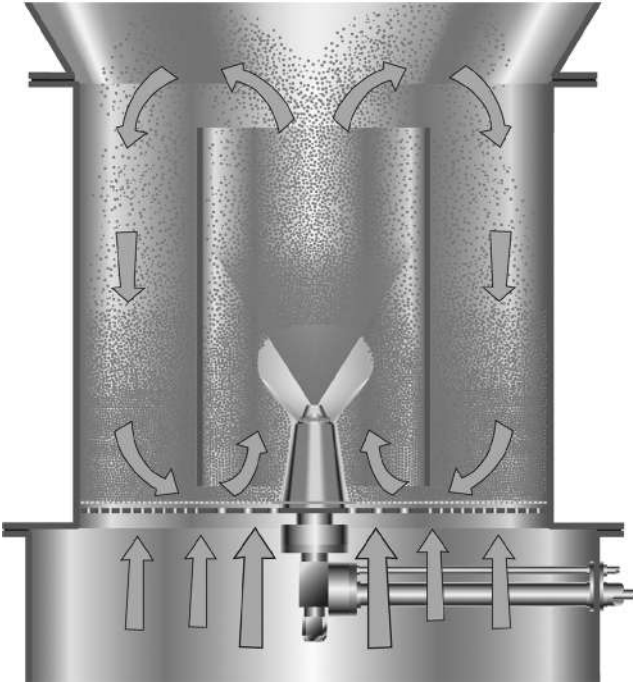
The other advance of significance is the development of a rotary fluid bed for producing denser granulation. Modules were introduced by various manufacturers, and the technology is discussed below. The 1972 patent (154) for the rotor technology was awarded for the equipment and coating of the granular material. The subsequent patents (155,156) were awarded for the coating of the spherical granules. An advantage of rotary fluid bed processing to produce granules over the conventional top-spray granulation technique was reported by Jager and Bauer (155). In this unit, the conventional air distributor is replaced by the rotating disk. The material to be granulated is loaded on the rotating disk. The binder solution is added through the atomization nozzle, located tangentially to the wall of the bowl. The centrifugal force creates a dense, helical doughnut-shaped pattern. This type of motion is caused by the three directional forces.

The vertical movement is caused by the gap or slit air around the rotating disk, the gravitational force folds back the material to the center, and the centrifugal force caused by the rotating disk pushes the material away from the center. The granulation produced in the rotary fluid bed processor shows less porosity, compared to the

(A)

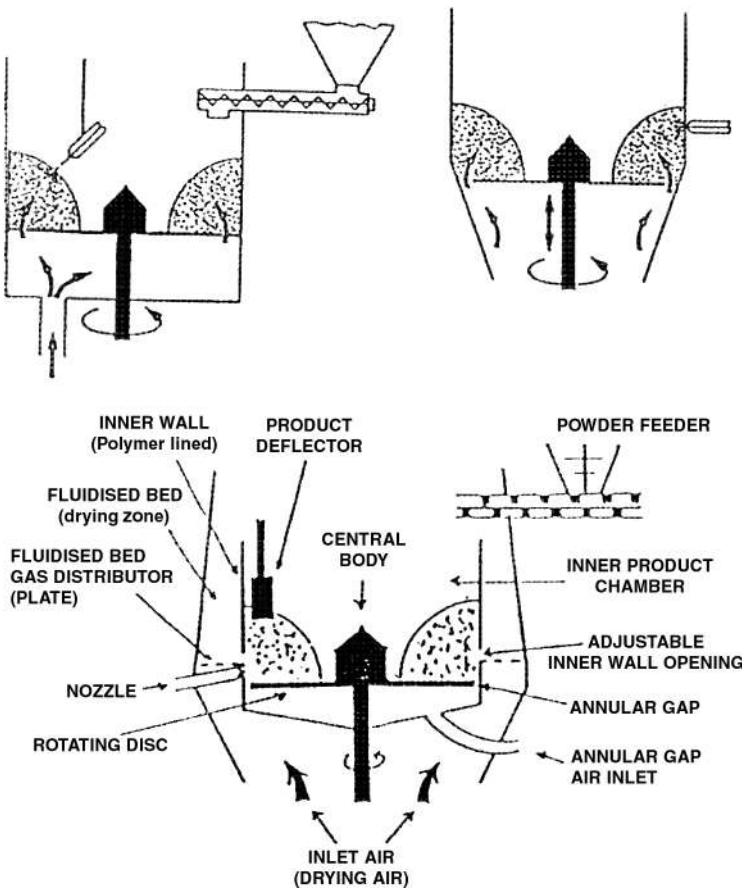


(B)



**Figure 40** (A) Wurster Coater schematic. (B) Wurster Coater. (Courtesy of the Vector Corporation.)

conventionally agglomerated product in the fluid bed processor. There are essentially two designs of this rotary fluid bed module which are available: the single-chamber design and the double-chamber design (Fig. 41). In the single-chamber design, the conventional air distributor is replaced by the rotating disk, which has variable size slit opening between the bowl wall and the rotor disk. The fluidizing air enters the mixing zone in the bowl through the slit. The single-chamber design is manufactured by Glatt (W.Glatt GMBH, Binzen, Germany), as Glatt Rotor Granulator<sup>®</sup>, and by



**Figure 41** Various rotary fluid bed inserts.

Freund (Freund Industrial Co. Ltd., Tokyo, Japan), as a Spir-a-flow<sup>®</sup> granulator. The double-chamber design was patented and manufactured by Aeromatic-Fielder AG (Aeromatic-Fielder AG—now Niro Pharma Systems, Bubendorf, Switzerland) (158). An inner stainless steel wall, encompassing the area called the forming zone is surrounded by an annular drying zone. The forming zone has a rotating disk. The gap air around the rotating disk allows the free movement of the disk. The stainless steel wall separating the forming zone and drying zone can be raised, so that the rotating product transfers in the drying zone through the gap created during the drying mode between the stationary and movable walls. The process air fluidizes the product through the annular drying zone. As the partially dried product reaches the upper boundary of the forming zone, the particle velocity slows down due to the design of the unit and the particles fall back in the forming zone. These partially dried particles, eventually, go through the same path in a cyclic pattern, until the desired moisture content is reached. The rotary fluid bed, with its different designs listed above, do provide granules which have less porosity, and higher bulk density compared to the granulation produced by the typical top spray granulated fluid bed process.

Türkoglu et al. produced Theophylline granulation using a rotary fluid bed (159). The formulation contained lactose, starch, and microcrystalline cellulose,



along with Theophylline. They reported that the granules produced were spherical and dense. Three different drug level formulations were evaluated. The authors concluded that the rotary fluid bed, as a wet granulator, has the potential to obtain a better drug content uniformity for tablets even at low active levels such as 1% in comparison with conventional fluidized beds. The use of rotary fluid bed to produce spherical granules for modified release application is reported by a number of authors. Rotary fluid bed technology was reviewed by Li et al. (160), and its usefulness was described to produce the pellets. The comparison of the rotary fluid bed processing with the multiple-step extrusion and spheronization was reported by Robinson et al. (161). The authors manufactured acceptable immediate release acetaminophen pellets, using both of these techniques. The quality of the pellet produced improved as the minimum quantity of product was increased in the rotary fluid bed processor. The advantage of using a single unit, such as the rotary fluid bed, over the multiple-unit process involving several pieces of equipment was described.

The rotary fluid bed is used for producing a pellet by layering the active drug suspension or solution on to nonpareil cores, and subsequently coating them with polymers to impart modified release properties (162). Hileman et al. (163) reported the manufacture of immediate spheres of a poorly water-soluble drug in a rotary fluid bed by layering the active drug suspension on to nonpareil cores. These immediate release spheres were then overcoated with an ethylcellulose/HPMC hydroalcoholic solution in the same unit, eliminating the need for additional process and handling steps. Iyer et al. evaluated layering of aqueous solution of phenylpropanolamine hydrochloride with different binders (164). The layered beads were coated in the rotoprocessor and the Wurster Coater to compare the utility of the rotoprocessor as an equipment, not only to produce pellets, but to coat them as well. Various equipment manufacturers have promoted powder layering on the pellets, in a rotary fluid bed. In 1992, Jones et al. received a patent for such a process (165). The process claims to have advantages of layering a drug substance with a relatively small amount of liquid, thus making this layering process more efficient. The commercial application of this process has not been reported in the literature. Korakianiti et al. (166) studied the preparation of pellets using rotary fluid bed granulator. The authors concluded that the rotor speed and the amount of water significantly affected the geometric mean diameter of the pellets, and they proposed an equation to show that correlation. Pišek et al. (167) studied the influence of rotational speed and surface of rotating disk on pellets produced by using rotary fluid bed. They used a mixture of pentoxifylline and microcrystalline cellulose to produce pellets, using a suspension of Eudragit® NE 30 D as a binder. The results showed that both the surface and the rotational speed of the disk have an influence on the shape, surface, and size of the pellets, while there was less effect on the density, humidity content, and yield. They found that the textured surface of the disk produced pellets with a rougher surface when the rotational speed was increased compared to the smooth surface, where increased rotational speed produced more spherical pellets with a larger diameter. Jan Vertommen (168) has summarized the use of rotary fluid bed processor to produce pellets.

### 11.3. Integrated Systems

The fluid bed technology is used for drying, agglomerating, coating, and pelletization. The trend in the industry is toward integrating various steps currently used to produce the solid dosage products. In an attempt to minimize the number of steps

involved, fluid bed granulation and drying is increasingly planned in the following three ways:

1. Fluid bed processor for granulation and drying
2. Integration of high-shear mixer and a fluid bed dryer
3. Integration of high-shear mixer with fluid bed dryer for containment of potent compounds.

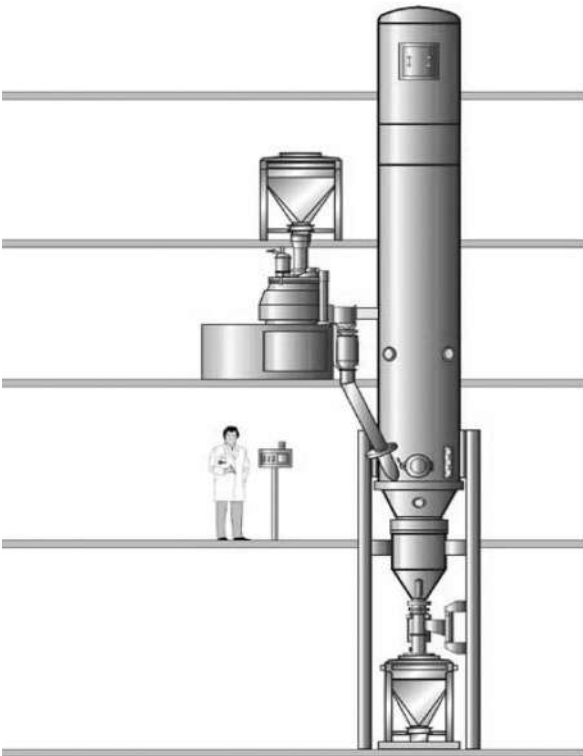
### 11.3.1. *The Granulation and Drying Carried Out in a Single Unit*

To minimize material handling steps, the fluid bed units are loaded by gravity or by vacuum, as described previously. Discharge of the product from the unit is accomplished by either side or bottom discharge, by employing pneumatic transport system. The CIP of such a unit can be accomplished by using stainless steel cartridge filters and an overlap gill air distributor, if desired.

### 11.3.2. *Integration of a High-Shear Mixer and a Fluid Bed Dryer*

Figures 42 and 43 show a typical integrated system, where containment is considered for controlling dust and cross-contamination. When these two-unit operations are integrated as a single unit, a number of points must be considered. The following is a list of some of the questions that the reader may want to consider:

1. Engineering layout and the footprint, ceiling height requirements.
2. How will the high-shear mixer be loaded—by gravity, vacuum, or manually?



**Figure 42** Integrated system. (Courtesy of the Glatt Group.)



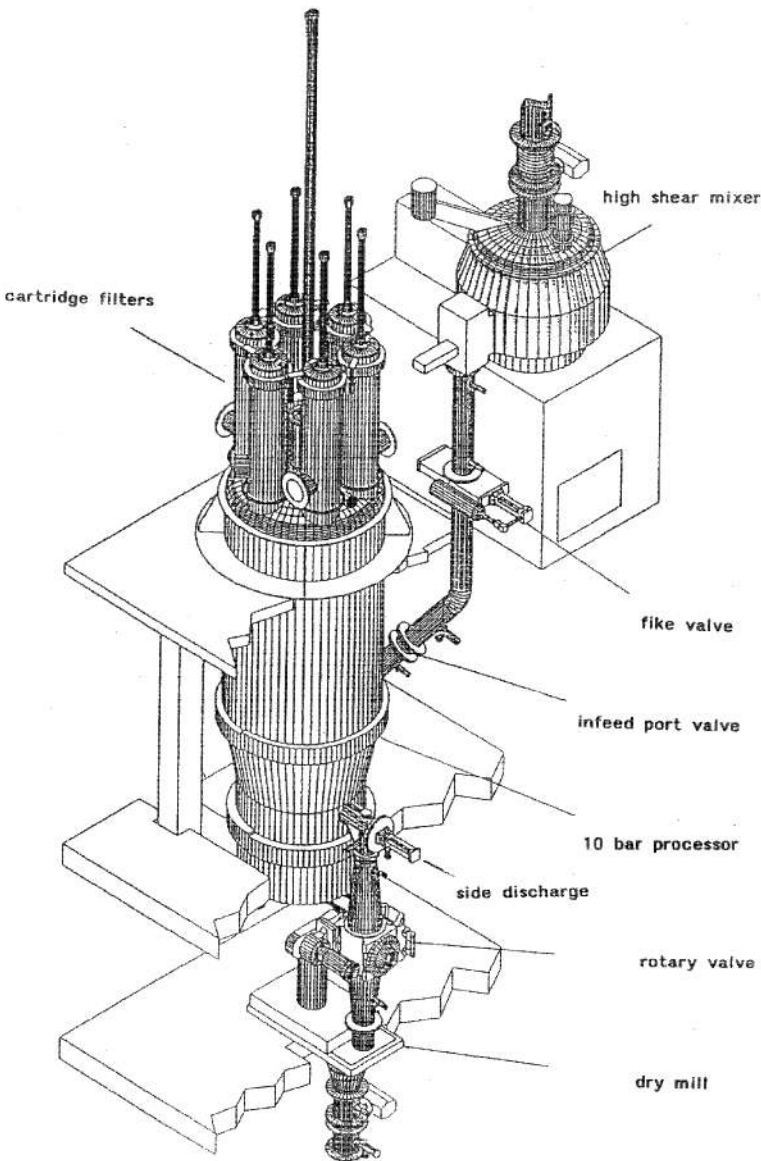
**Figure 43** Integrated system. (Courtesy of the Glatt Group.)

3. How will the binder solution be prepared and delivered to the mixer?
4. How will the granulation end point be determined and reproduced?
5. How will the discharge from the high-shear mixer be accomplished?
6. Are the process parameters for granulation and fluid bed drying established and reproducible, indicating a robust process?
7. How will the product, discharged from the fluid bed dryer be handled? Does it require sizing, blending with the lubricants?
8. Is this system dedicated for a single product or multiple products?
9. How will this system be cleaned?
10. Will the control of a process be done individually for each unit or by an integrated control system?

For the potent compound processing, requiring high-shear granulation and fluid bed drying, all the questions mentioned previously must be considered. In addition, the operator safety, special sampling valves, isolated room air handling systems, and CIP must be considered. Such an integrated system can be dedicated for a single product.

Figure 44 shows a system where a potent compound is processed. After the raw materials are dispensed, operating personnel do not have to handle the product during the granulation drying steps. Such a system is costly and does require an enormous amount of time for process and cleaning validation.

The fluid bed process, like other granulation techniques requires understanding of the importance of characterization of the raw materials, especially of a drug substance, the process equipment, limitations of the selected process, establishment of in-process control specifications, characterization of the finished product, and clean-



**Figure 44** Integrated system for potent compound. (Courtesy of Niro Pharma Systems.)

ing and process validation. It is equally important that the formulation and development scientists do not lose sight of the fact that the process being developed will be going on the production floor and should be robust enough.

## ACKNOWLEDGMENT

My sincere thanks to Ms. Christine Budny, my assistant at Synthron Pharmaceuticals Inc., for her help in preparing this chapter.

## REFERENCES

1. Kunii D, Lvenspiel O. *Fluidization Engineering*. New York: John Wiley & Sons, Inc., 1968.
2. Wurster DE. *J Am Pharm Assoc Sci Ed* 1960; 49:82.
3. Wurster DE. *J Am Pharm Assoc Sci Ed* 1959; 48(8):451–454.
4. Scott MW, Liberman HA, Rankell AS, Battista JV. *J Pharm Sci* 1964; 53(3):314–319.
5. Rankell AS, Scott MW, Liberman HA, Chow FS, Battista JV. *J Pharma Sci* 1964; 53(3):320.
6. Contini S, Atasoy K. *Pharm Ind* 1966; 28:144–146.
7. Wolf G. *Drugs Made Germany* 1968; 11:172–180.
8. Liske T, Mobus W. The manufacture and comparative aspects of fluidized layer spray granulation. *Drugs Made Germany* 1968; XI:182–189.
9. Sherrington PJ, Oliver R. Granulation monograph (chapter 3). In: Goldberg AS, ed. *Powder Science and Technology*. London: Heyden, 1981.
10. Pietch WB. In: Fayed ME, Otten L, eds. *Handbook of Powder Science and Technology*. New York: Van Nostrand Reinhold, 1984.
11. Hersey JA. Fluidized bed technology—an overview. *Int J Pharm Tech Prod Manuf* 1981; 2(3):3–4.
12. Thiel WJ. The theory of fluidization and application to the industrial processing of pharmaceutical products. *Int J Pharm Tech Prod Manuf* 1981; 2(5):5–8.
13. Thiel WJ. Solids mixing in gas fluidized beds. *Int J Pharm Tech Prod Manuf* 1981; 2(9):9–12.
14. Littman H. An overview of flow in fluidized beds. *Pharm Technol* 1985; 9(3):48.
15. Whitehead AB. Behavior of fluidized bed systems. *Pharm Technol* 1981; 2(13).
16. Story MJ. Granulation and film coating in the fluidized bed. *Pharm Technol* 1981; 2(19):19–23.
17. Aulton MJ, Banks M. Fluidized bed granulation; factors influencing the quality of the product. *Pharm Technol* 1981; 2(24):24–27.
18. Kulling W, Simon EJ. Fluid bed technology applied to pharmaceuticals. *Pharm Technol* 1980; 4(1):79–83.
19. Gomezplata A, Kugelman AM. Processing systems. In: Marchello JM and Gomezplata A, eds. *Gas–Solid Handling in the Process Industries, Chemical Processing and Engineering Vol. 8*. New York: Marcel Dekker, Inc., 1976:chap 4.
20. E. Räsänen et al. *AAPS PharmSci*, 3(3) Abstract, AAPS Annual Meeting 2001.
21. Parikh DM. Airflow in batch fluid-bed processing. *Pharm Technol* 1991; 15(3):100–110.
22. Row PN, et al. *Trans Inst Chem Eng* 1965; 32T:271.
23. Davis L, et al. *Trans Inst Chem Eng* 1966; 44T:293.
24. Gorrodnichev VI, et al. *Pharm Chem J (USSR)* 1974; 8:298.
25. Thiel WJ. The theory of fluidization and application to the industrial processing of pharmaceutical products. *Int J pharm Tech Prod Manuf* 1981; 2(5).
26. Zenz FA. In: Kirk-Othmer, ed. *Fluidization: Encyclopedia of Chemical Technology*, Vol. 10, 3rd ed. New York: Wiley-Interscience Publication, 548–581.
27. Ennis BJ, Tardos GI, Pfeffer R. A micro-level-based characterization of granulation phenomena. *Powder Technol* 1991; 65:257–272.
28. Osborne BG, Fearn T, Hindle PH. In: *Practical NIR Spectroscopy with Applications in Food and Beverage Industry Analysis*. 2nd ed. Harlow, U.K.: Longman, 1993:227.
29. Long GE. *Spraying theory and practice*. *Chem Eng* 1978:73–77.
30. Masters K. *Spray Drying, an Introduction to Principles, Operational Practice and Application*. 2nd ed. New York: John Wiley & Sons Inc., 1976.
31. Japanese Patent Application 61–259696, 1986.
32. Swiss Patent 0176/93, 1993, U.S. Patent 5,444,892, 1995, European Patent 0572356A1.
33. Guidance for Industry, Part 11, Electronic Records; Electronic Signatures—Scope and Application, February 2003.

34. Newitt DM, Conway-Jones JM. A contribution to the theory and practice of granulation. *Int J Pharm Tech Prod Manuf* 1958; 36:422.
35. Record PC. A review of pharmaceutical granulation technology. *Int J Pharm Tech Prod Manuf* 1980; 1:32.
36. Rumpf H. In: Krepper W, ed. *Agglomeration*. New York: Interscience, 1962:374.
37. Tardos GI, Khan MI, Mort PR. Critical parameters and limiting conditions in binder granulation of fine powders. *Powder Technol* 1997; 94:245–258.
38. Iveson SM. Granule coalescence modeling: including the effects of bond strengthening and distributed impact separation forces. *Chem Eng Sci* 2001; 56:2215–2220.
39. Schaefer T, Worts O. Control of fluidized bed granulation I. Effects of spray angle, nozzle height and starting materials on granule size and size distribution. *Arch Pharm Chem Sci Ed* 1977; 5:51–60.
40. Smith PJ, Nienow AW. *Chem Eng Sci* 1983; 38(8):1223–1231, 1323–1240.
41. Aulton ME, Banks M. *Int J Pharm Tech Prod Manuf* 1981; 2(4):24–29.
42. Maroglou A, Nienow AW. 4th Symposium on Agglomeration, Toronto, Canada, Iron & Steel Society Inc., June 1985:465–470.
43. Maroglou A, Nienow AW. Fluidized bed granulation technology and its application to tungsten carbide. *Powder Metall* 1986; 29(4):195–291.
44. McCabe WL, Smith JC. In: Lachman L, Liberman HA, Kanig JL, eds. *Unit Operations of Chemical Engineering*. New York: McGraw-Hill, 1956:Inc.
45. Green Don W, ed. In: Perry's Chemical Engineer's Handbook. New York : McGraw-Hill, Inc., 1984:section 20.
46. Rankell RS, Liberman HA, Schiffman RF. Drying. In: *The Theory and Practice of Industrial Pharmacy*. 3rd ed. Philadelphia, PA: Lea & Feabiger, 1986.
47. Schaefer T, Worts O. Control of fluidized granulation III, effects of the inlet air temperature, and liquid flow rate on granule size and size distribution. Control of moisture content of granules in the drying phase. *Arch Pharm Chem Sci Ed* 1978; 6(1):1–13.
48. Gao JZH, et al. AAPS PharmSci, 1(4) Abstract (Tech Note), AAPS Annual Meeting 2000.
49. Thurn U. Dissertation, Eidgenossischen Technischen, Hochschule, Zurich, 1970.
50. Liske T, Mobus W. *Drugs Made Germany* 1968; 11(4):182–189.
51. Schaefer T, Worts O. Control of fluidized bed granulation, I. Effects of spray angle, nozzle height and starting materials on granule size and size distribution. *Arch Pharm Chem Sci Ed* 1977; 5:51–60.
52. Schaefer T, Worts O. Control of fluidized bed granulation V, factors affecting granule growth. *Arch Pharm Chem Sci Ed* 1978; 6:69–82.
53. Ormos Z, Pataki K. *Hung J Ind Chem* 1979; 7:89–103.
54. Ormos Z, Pataki K. *Hung J Ind Chem* 1979; 7:105–117.
55. Banks M. Ph.D. Thesis, C.N.A.A., Leicester Polytechnic, 1981.
56. Galmen MJ, Greer W. Paper 2. Fluid Technology and Pharmaceutical Manufacturing International Conference, 1982.
57. Aulton ME. Paper 3. Fluid Technology and Pharmaceutical Manufacturing International Conference, Powder Advisory Center, London, 1982.
58. Veillard M, et al. *Int J Pharm Tech Prod Manuf* 1982; 3(4):100–107.
59. Georgakopoulos PP, et al. *Pharmazie* 1983; 38(4):240–243.
60. Jinot JC, et al. *STP Pharm* 1986; 2(13):126–131.
61. Shinoda A, et al. *Yakuzaigaku* 1976; 36(2):83–88.
62. Aulton ME, et al. *J Pharm Pharmacol* 1977; 29(suppl):59.
63. Schepky G. *Acta Pharm Technol* 1978; 24(3):185–212.
64. Aulton ME, et al. Proceedings of the International Conference on Powder Technology in Pharmacy, Powder Advisory Center, Basel, Switzerland, June 1979.
65. Kocova El-Arini S, et al. *Drugs Made Germany* 1983; 26(4):205–211.
66. Davies WL, Gloor WT. *J Pharm Sci* 1972; 61(4):618–622.
67. Rouiller M, et al. *Acta Pharm Technol* 1975; 21(2):129–138.

68. Schaefer T, Worts O. Control of fluidized bed granulation II, estimation of droplet size of atomized binder solution. *Arch Pharm Chem Sci Ed* 1977; 5:178–193.
69. Ormos Z, et al. *Hung J Ind Chem* 1979; 7:131–140.
70. Ormos Z, et al. *Hung J Ind Chem* 1979; 7:141–151.
71. Ormos Z, et al. *Hung J Ind Chem* 1979; 7:153–163.
72. Ormos Z, et al. *Hung J Ind Chem* 1979; 7:221–235.
73. Kocova El-Arini S. *Pharm Ind* 1981; 43(7):674–679.
74. Jager KF, Bauer KH. *Acta Pharm Technol* 1984; 30(1):85–92.
75. Nouh ATI. *Pharm Ind* 1986; 48(6):670–673.
76. Alkan H, et al. *Doga Tu J Med Pharm* 1987; 11(1):1–7.
77. Bank A, et al. *Proc 2nd Conf Appl Phys Chem* 1971; 2:687–692.
78. Davies WL, Gloor WT. *J Pharm Sci* 1973; 62(1):170–172.
79. Ormos Z, et al. *Hung J Ind Chem* 1973; 1:307–328.
80. Ormos Z, et al. *Hung J Ind Chem* 1973; 1:463–474.
81. Johnson MCR, et al. *J Pharm Pharmacol* 1975; suppl:80.
82. Schaefer T, Worts O. Control of fluidized bed granulation IV. Effects of binder solution and atomization on granule size and size distribution. *Arch Pharm Chem Sci Ed* 1978; 6:14–25.
83. Aulton ME, et al. *Mfg Chem Aerosol News* 1978; 12:50–56.
84. Gorodnichev VI, et al. *Pharm Chem J (USSR)* 1980; 14(10):72–77.
85. Ceschel GC, et al. *II Farm Ed Prat* 1981; 36(6):281–293.
86. Rangnarsson G, et al. *Int J Pharm* 1982; 12:163–171.
87. Meshali M, El-Banna HM, El-Sabbagh H. *Pharmazie* 1983; 38(5):323–325.
88. Hajdu R, Ormos Z. *Hung J Ind Chem* 1983; 12:425–430.
89. Devay A, et al. *Acta Pharm Technol* 1984; 30(3):239–242.
90. Alkan MH, Yuksel A. *Drug Dev Ind Pharm* 1986; 12(10):1529–1543.
91. Hontz J. Assessment of Selected Formulation and Processing Variables in Fluid Bed Granulation, Ph.D. Thesis, University of Maryland, Baltimore, MD, 1987; Dissertation Abs Int 1987; 6:1655-B.
92. Wan LSC, Lim KS. *STP Pharm* 1988; 4(7):560–571.
93. Wan LSC, Lim KS. *STP Pharm* 1989; 5(4):244–250.
94. Sheskey P, Keary C, Inbasekaran P, Deyarmond V, Balwinski K. Foam technology: the development of a novel technique for the delivery of aqueous binder systems in high shear and fluid-bed wet-granulation applications. Poster at AAPS Annual Meeting, Oct 26–30, 2003.
95. Dahl TC, Bormeth AP. Naproxen controlled release matrix tablets: fluid bed granulation feasibility. *Drug Dev Ind Pharm* 1990; 16(4):581–590.
96. Wan Lucy SC, Heng Paul WS, Muhuri G. Incorporation and distribution of a low dose drug in granules. *Int J Pharm* 1992; 88:159–163.
97. Higashide F, Miki Y, Nozawa Y, Ishibashi K. Dependence of drug content uniformity on particle sizes in fluidized bed granulation. *Pharm Ind* 1985; 47(11):1202–1205.
98. Davies WL, Gloor WT Jr. Batch production of pharmaceutical granulation in fluidized bed II: effects of various binders and their concentrations on granulations and compressed tablets. *J Pharm Sci* 1972; 61:618.
99. Davies WL, Gloor WT Jr. Batch production of pharmaceutical granulation in fluidized bed III: binder dilution effects on granulation. *J Pharm Sci* 1973; 62:170.
100. Seo A, Holm P, Schaefer T. Effects of droplet size and type of binder on the agglomerate growth mechanisms by melt agglomeration in a fluidized bed. *Eur J Pharm Sci* 2002; 16:95–105.
101. Rawley FA. Effects of the bag shaking cycle on the particle size distribution of granulation. *Pharm Technol* 1989; 13(9):78–82.
102. Davies WL, Gloor WT Jr. Batch production of pharmaceutical granulation in fluidized bed I: effects of process variables on physical properties of final granulation. *J Pharm Sci* 1971; 60(12):1869–1874.

103. Workman J Jr. A review of process near infrared spectroscopy: 1980–1994. *J. Near Infrared Spectrosc* 1993; 1:221–245.
104. U.S. Patent USP XXVII 2004.
105. Near Infra Red Spectrometry. *European Pharmacopoeia* June 2004:59.
106. Choppin G, Buijs K. Near infrared studies of structure of water-II. Ionic solutions. *J Chem Phys* 1963; 39:2042–2050.
107. Osborne BG, Fearn T, Hindle PH. In: *Practical NIR Spectroscopy with Applications in Food and Beverage Industry Analysis*, 2nd ed. Harlow, U.K.: Longman, 1993.
108. Fong A, Hieftje GM. Near infrared measurement of relative and absolute humidity through detection of water adsorbed on a silica gel layer. *Anal Chem* 1995; 67: 1139–1146.
109. Siesler HW, Ozaki Y, Kawata S, Heise HM. *Near-Infrared Spectroscopy: Principles, Instruments and Applications*. Weinheim, Germany: Wiley, 2002.
110. Wetzel DL. Near infrared reflectance analysis: sleeper among the spectroscopic techniques. *Anal Chem* 1983; 55(12):1165A–1175A.
111. McDonald BF, Pebble KA. Some application of near-infrared reflectance analysis in the pharmaceutical industry. *J Pharm Biomed Anal* 1993; 11(11–12):1077–1085.
112. Sinsheimer J, Poswalk N. Pharmaceutical applications of the near infrared determination of water. *J Pharm Sci* 1968; 57:2007–2010.
113. Wetzel DL. Near infrared reflectance analysis: sleeper among the spectroscopic techniques. *Anal Chem* 1983; 55(12):1165A–1175A.
114. Workmann JJ. Review of process and non-invasive near-infrared and infrared spectroscopy 1193–1999. *Appl Spectrosc Rev* 1999; 34:1–89.
115. Callis J, Illman D, Kowalski B. Process analytical chemistry. *Anal Chem* 1987; 59:624A–637A.
116. Beebe K, Blaser W, Bredeweg R, Chauvel J, Harner R, LaPack M, Leugers A, Martin D, Wright L, Yalvac E. Process analytical chemistry. *Anal Chem* 1993; 65:199R–216R.
117. Blaser W, Bredeweg R, LaPack M, Leugers A, Martin D, Pell R, Workman J, Wright L. Process analytical chemistry. *Anal Chem* 1995; 67:47R–70R.
118. Hassel D, Bowman E. Process analytical chemistry for spectroscopists. *Appl Spectrosc* 1998; 52:18A–29A.
119. Workman J Jr, Veltkamp D, Doherty S, Anderson B, Creasy K, Koch M, Tatera J, Robinson A, Bond L, Burgess L, Bokerman G, Ullman A, Darsey G, Mozayeni F, Bamberger J, Greenwood M. Process analytical chemistry. *Anal Chem* 1999; 71:121R–180R.
120. Brittain H. Methods for the characterization of polymorphs and solvates in polymorphism in pharmaceutical solids. In: Brittain H ed. 1st ed. New York: Marcel Dekker Inc., 1999:227–278.
121. Frake PD, Greenhgh SM, Grierson JM, Hempenstall, Rudd DR. Process control and end-point determination of fluid bed granulation by application of near-infrared spectroscopy. *Int J Pharm* 1997; 151:75–80.
122. Rantanen JO, Antikainen JP, Mannermaa, Yliuusi J. Use of near-infrared reflectance method for measurement of moisture content during granulation. *Pharm Dev Technol* 2000; 5(2):209–217.
123. Rantanen J, Lehtola S, Rämetsä P, Mannermaa JP, Ylirussi. On-line monitoring of moisture content in an instrumented fluidized bed granulator with multi-channel NIR moisture sensor. *Powder Technol* 1998; 99:163–170.
124. Andersson M, Folestad S, Gottfires J, Johansson MO, Josefson M, Wahlund KG. Quantitative analysis of film coating in a fluidized-bed process by in-line NIR spectroscopy and multivariate batch calibration. *Anal Chem* 2000; 72:2099–2108.
125. Vazquez ER. Optimization of Drying-End-Points Measurements for the Automation of a Fluidized-Bed Dryer Using FT-NIR Spectroscopy. M.S. Thesis, University of Puerto Rico, 2004.



126. Rantanen J, Käsäkoski M, Tenhunen J, Lehtonen S, Rajalahti T, Mannermaa J, Yliuusi J. Next generation fluidized bed granulator automation. *AAPS PharmSciTech* 2000; 1(2):article 10.
127. Rantanen JA, Jørgensen E, Räsänen, Luukkonen P, Airaksinen S, Raiman J, Hänninen K, Antikainen O, Yliuusi J. Process analysis of fluidized bed granulation. *AAPS Pharm SciTech* 2001; 2(4):article 21.
128. Rantanen J, Sampsa JL, Osmo KA, Jukka-Pekka M, Olli ES, Jouko KY. Visualization of fluid bed granulation with self organizing maps. *J Pharm Biomed Anal* 2001; 24(3):343–352.
129. Laitinen N, Antikainen O, Airaksinen S, Yliuusi J. At-line particle size analysis with a novel optical technique during a fluidized-bed granulation process. Poster at AAPS Annual Meeting, 2002.
130. Jha BK, Tambe SS, Kulkarni BD. Estimating diffusion coefficients of a micellar system using an ANN. *J Coll Interface Sci* 1995; 170:392–398.
131. Bourquin J, Schmid H, Van Hoogevest P, Leunberger H. Basic concepts of ANN modeling in the application to pharmaceutical development. *Pharm Dev Technol* 1997; 2(2):95–109, 111–121.
132. Watano S, Takashima H, Miyanami K. Control of moisture content in fluidized bed granulation by neural network. *J Chem Eng Jpn* 1997; 30(2):223–229.
133. Leane MM, Cumming I, Corrigan OI. The use of artificial neural networks for the selection of the most appropriate formulation and processing variables in order to predict the in vitro dissolution of sustained release minitabs. *AAPS PharmSciTech* 2003; 4(2):article 26.
134. Vandel DA, Davari, Famouri P. Modeling of fluidized bed neural networks. *Proceedings of 32nd IEEE SSST, Tallahassee, FL, March 2000, FAMU-FSU.*
135. Quantrille TE, Liu YA. In: *Artificial Intelligence in Chemical Engineering*. San Diego: Academic Press, 1991.
136. AAPS/FDA. Scale-up of Oral Solid Dosage Forms, December 11–13, 1991.
137. Food and Drug Administration. Immediate Release Solid Dosage Forms. Scale-up and Post Approval Changes: Chemistry, Manufacturing and Control, In-vitro Dissolution Testing and In-Vivo Bioequivalence Documentation. Rockville, MD: FDA Center for Drug Evaluation and Research, November 30, 1995.
138. Gore AY, McFarland DW, Batuyios NH. Fluid bed granulation: factors affecting the process in laboratory development and production scale-up. *Pharm Technol* 1985; 9(9):114.
139. Bonck JA. Spray granulation. Presented at the AIChE Annual Meeting, November, 1993.
140. Jones DM. Factors to consider in fluid bed processing. *Pharm Technol* 1985; 9(4):50.
141. Matharu AS, Patel MR. A new scale-up equation for fluid bed processing. Poster at AAPS Annual Meeting, 2003.
142. Rambali B, Baert L, Massart DL. Scaling up of the fluidized bed granulation process. *Int J Pharm* 2003; 252(1–2):197–206.
143. Simon EJ. Fluid bed processing of bulk solids. In: *Third International Powder Technology and Bulk Solids Conference*, February 20, 1975. Harrogate, U.K.: Heyden & Sons Publisher, 1975:63–73.
144. Kulling W. Method and Apparatus for Removing a Vaporized Liquid from Gas for Use in a Process Based on the Fluidized Bed Principle. U.S. Patent 4,145,818, March 27, 1979.
145. ATEX Directive 94/9/EC of the European Parliament and the Council, March 23, 1994.
146. Parikh DM. Fluid bed processing in the 1990s. In: *Tabletting and Granulation Yearbook*. *Pharm Technol* 1996; suppl:40–47.
147. International Patent WO 93/08923, 1993.
148. International Patent WO 95/20432, 1995.

149. Glatt Brochure on STRATOS<sup>®</sup>.
150. Walter KT, et al. Fluidized bed precision granulation with real time process determination. Poster at AAPS Annual Meeting, 2003.
151. Doelling MK, et al. The development of a microwave fluid bed processor I: construction and qualification of a prototype laboratory unit. *Pharm Res* 1992; 9(11):1487–1492.
152. Doelling MK, Nash RA. The development of a microwave fluid bed processor II: drying performance and physical characteristics of typical pharmaceutical granulations. *Pharm Res* 1992; 9(11):1493–1501.
153. Luy B, Hirschfeld P, Leuenberger H. Granulation and drying in vacuum fluid-bed system. *Pharm Ind* 1989; 51:89.
154. U.S. Patent 3,671,296, June 20, 1977.
155. U.S. Patent 4,034,126, July 5, 1977.
156. U.S. Patent 4,542,043, Sep 17, 1985.
157. Jäger KF, Bauer KH. Effect of material motion on agglomeration in the rotary fluidized-bed granulator. *Drugs Made Germany* 1982; 25:61–65.
158. U.S. Patent 4,740,390.
159. Türkoglu M, He M, Sakr A. Evaluation of rotary fluidized-bed as a wet granulation equipment. *Eur J Pharm Biopharm* 1995; 41(6):388–394.
160. Li Shun P, Kowarski CR, Feld KW, Grim WM. Recent advances in microencapsulation technology and equipment. *Drug Dev Ind Pharm* 1988; 14(2,3):353–376.
161. Robinson RL, Hollenbeck G. Manufacture of spherical acetaminophen pellets: comparison of rotary processing with multiple-step extrusion and spheronization. *Pharm Technol* 1991; 15(5):48–56.
162. Parikh DM. Layering in rotary fluid bed a unique process for the production of spherical pellets for controlled release. Interphex, New York, May 18, 1991.
163. Hileman GA, Sarabia RE. Manufacture of immediate and controlled release spheres in a single unit using fluid bed rotor insert. Poster PT 6167 at AAPS Annual Meeting, 1992.
164. Iyer RM, Augsburg LL, Parikh DM. Evaluation of drug layering and coating: effect of process mode and binder level. *Drug Dev Ind Pharm* 1993; 19(9):9891–9998.
165. U.S. Patent 5,132,142, 1992.
166. Korakianti ES, Rekkas DM, Dallas PP, Choulis NH. Optimization of the pelletization process in a fluid bed rotor granulator using experimental design. *AAPS PharmSciTech* 2000;1(4):article 35.
167. Pišek R, Planinšek O, Tuš M, Srčič S. Influence of rotational speed and surface of rotating disc on pellets produced by direct rotor pelletization. *Pharm Ind* 2000; 62:312–319.
168. Vertommen J. Pelletization in a rotary processor using the wet granulation technique. In: *ACTA Biomedica Lovaniasia Leuven*. Belgium Leuven University Press, 1998:166.

# 10

## Single-Pot Processing

**Harald Stahl**

*Niro Pharma Systems, Muellheim, Germany*

**Griet Van Vaerenbergh**

*Collette N.V., Wommelgren, Belgium*

### 1. INTRODUCTION

Single-pot processing was developed to provide the means for mixing, granulating, drying, and blending pharmaceutical granulations in a single apparatus. Although equipment design varies from manufacturer to manufacturer (Figs. 1–3), this category of processors consists of a high- or low-shear mixer–granulator (similar to conventional granulators) and outfitted with a variety of drying options. Initially, vacuum was combined with a heat-jacketed bowl to provide the means for drying in the single pot. Today, processors are available that provide vacuum drying with microwaves or that percolate gas under low pressure into the vacuum chamber (i.e., processing bowl). Another very interesting improvement is the use of swinging processing bowls (1).

Single-pot processors for the pharmaceutical industry have been available for years. They received renewed interest in the mid-1980s when microwaves were coupled with vacuum to enhance the drying operation. Microwaves applied to drying pharmaceutical granulations became synonymous with single-pot processing, and there was anticipation that this technology would eventually become the norm for granulation processing. Several major pharmaceutical companies purchased production-scale units following successful trials conducted at vendors' pilot facilities. In the ensuing years, when the technology did not become as popular as expected, there were rumors that microwave systems could not be validated and suffered from excessive regulatory hurdles. The reality is neither, and single-pot technology has continued to evolve during the last decade. It has de-emphasised its association with microwave drying while continuing to demonstrate its appropriate role in granulation technology (2).

In a production setting, single-pot processing may offer a number of advantages. By integrating granulating and drying capabilities into a single unit, capital investment in equipment and good manufacturing practice floor space may be lower than the other alternatives. The number of material-handling steps is decreased; consequently, the total processing time may be shorter while maintaining a high yield



**Figure 1** UltimaPro™ 600 microwave/vacuum single-pot processor with swinging bowl. (Courtesy of Collette NV, Belgium.)

and keeping production support to a minimum. Environmental variables, such as humidity, are eliminated from the manufacturing process, which may offer advantages for processing moisture-sensitive formulations. State of the art is to outfit a single-pot processor with clean-in-place systems, thereby enhancing operator safety by minimizing exposure to the product both during manufacturing and during cleaning



**Figure 2** L.B. Bohle single-pot processor. (Courtesy of the L.B. Bohle Group, Germany.)



**Figure 3** Zanchetta single-pot processor. (Courtesy of Zanchetta, Italy.)

(3). Requirements for solvent recovery systems are lower for single-pot processors compared with fluid-bed driers. Single-pot processors outfitted with vacuum are attractive for evaporating events that are explosive or for containing drug substances with low-exposure limits.

The versatility and compactness of small-scale (3–25 L) single-pot processors also make the technology attractive for development and pilot laboratory facilities. Within the last few years, equipment manufacturers began offering single-pot processors that can accommodate the batch sizes required during early development (0.3 g–10 kg). The processors can be used as mixer–blenders for direct compression formulations, or as mixer–granulators to prepare wet granulations for fluid-bed drying, or utilized for their full range of capabilities as a single-processing unit for all the steps required for granulation preparation. Some vendors offer the option of upgrading their small-scale processors. For example, a user can initially purchase a single-pot processor with vacuum-drying capabilities and add a microwave drying system at a later time. Consequently, single-pot processors should be given strong consideration when equipping a development laboratory or a pilot plant intended to offer a variety of processing options to the pharmaceutical formulator.

The following text is intended to expose the reader to the drying methods, the capabilities, and the applications of single-pot processing to pharmaceutical granulations. Fluid-bed technology, which can also be used to mix, to granulate, and for drying alternative wet granulation technologies in a single unit, will not be addressed in this chapter because it is discussed elsewhere in this book.

## 2. TYPICAL SINGLE-POT PROCESS

The steps and sequence of manufacturing pharmaceutical granulations using single-pot processing are the same as those that use alternative technologies, except that

several of the steps are performed in the same product chamber. The majority of production installations make use of its mixing, granulating, and drying capabilities during the processing of a single batch. Important to note is the absence of a milling step in between granulation and drying. The advantage of a reduced number of process steps is obvious while the drawback is that there is no possibility of breaking lumps generated during granulation. Single-pot operations therefore require excellent control of the granulation to prevent the formation of oversized material.

## 2.1. Dry Mixing

Powders are loaded into the single pot either manually (for development-and pilot-scale units) or by a conveying system (for production-scale units). Vacuum pump(s) used for the drying operation can also be used to charge the processor. Pneumatic- and vacuum-conveying systems contribute to minimizing operator exposure to the drug product. The powders are mixed in the dry state until the desired degree of uniformity is obtained. Depending on the geometry of the processing bowl and the efficiency of its mixing blades, optimal mixing for most processors generally occurs when the bowl is charged to 50–75% of its capacity. Batch size, impeller speed, and mixing time are the variables that affect the desired degree of blend homogeneity before the addition of the binder solution.

## 2.2. Addition of Binder Solution

Once dry mixing is completed, the binder solution is added through a spray lance connected to a solvent delivery system (such as a pressure pot or peristaltic pump). For highly viscous binder solutions it is of advantage to use the vacuum system of the processor for sucking into the processor. Because the single-pot processor is operating as a granulator at this point, all variables considered during the manufacture of wet granulations in conventional high-or low-shear mixer-granulators are applicable. Those variables include the rate of binder action, droplet size, and spray pattern (the last two being determined by the selection of the spray nozzle and the distance between the nozzle tip and granulation bed). The speed of the main impeller and the granulating tool (e.g., high-intensity chopper bar), as well as the jacket temperature should also be controlled during binder addition.

## 2.3. Wet Massing

Following binder addition, additional energy may be imparted to the granulation until the desired consistency is obtained. The speeds of the main impeller and granulating tool, wet-massing time, and jacket temperature are variables that can affect the physical attributes of the granulation. Like the bowl shape the impeller design will also affect the amount of shear imparted to the granulation. Granulation end point may be controlled by process time, temperature of the product bed, and the energy consumption or torque of the main impeller.

## 2.4. Drying

After granulation, the material is dried using one of three approaches: (a) vacuum drying, (b) gas-assisted vacuum drying, or (c) microwave vacuum drying. Details

of each drying method are summarized in *Drying Methods for Single-Pot Processors*. The product bed is usually stirred at low intensity during the drying process to facilitate solvent removal and promote uniform drying, as well as to prevent caking of the granulation on the chamber's walls. Agitation may be applied by slowly tilting the bowl or operating the impeller at low speed, either continuously or intermittently, throughout the drying stage. Caution must be exercised to avoid granule breakdown during drying, which may result in unfavorable compression characteristics (4). Variables for vacuum drying include the level of vacuum maintained in the bowl, the jacket temperature, and the degree of agitation. In addition to the parameters listed for vacuum drying, gas-assisted vacuum drying must also consider the type of drying gas used and its rate of delivery. When microwave vacuum drying is used, all of the variables used for vacuum drying are applicable, as well as the level of microwave power used to dry the granulation. If yield is of greater importance than process time, a very interesting process option is to follow with the wall temperature very closely the product temperature and use as a source of drying energy only the introduced microwave energy. This mode of operation minimizes the amount of material sticking to the walls for the price of a prolonged drying operation resulting in a reduced throughput. This option is of special interest for the processing of highly expensive materials.

If required, cooling can be conducted at the conclusion of the drying operation. The heated water or steam in the bowl jacket, which supplied conductive heat during the drying process, can be replaced with a glycol–water solution to provide a contact surface as low as 10°C. Another approach to cool the granulation is by purging a cooling gas into the single pot while agitating the granulation bed.

## 2.5. Sizing and Lubrication

Once the granulation is dried, it is usually necessary to size it. This may be accomplished by discharging the material through an in-line mill into a receiving vessel, where it may be blended with any remaining excipients (e.g., lubricant and flavors). This process design maintains the containment benefits of the single-pot process. Alternatively, the remaining excipients may be added to the single-pot processor and blended with the granulation before discharging and milling. This approach requires that the lubricant be adequately distributed during milling and material transfer during the compression operation.

## 3. DRYING METHODS FOR SINGLE-POT PROCESSORS

### 3.1. Conductive Drying

The bowls of single-pot processors are generally jacketed for temperature control, which minimizes condensation of the granulating solvent and assists in solvent evaporation during drying. As a result, conductive heating provided by the heat-jacketed lid and the walls of the single pot contributes to the drying process. Its dependence on the transfer of heat through pharmaceutical powders, which are poor conductors of heat, prevents its use as the sole mode of drying in single-pot processors. Eq. 1 addresses the conductive drying component for solvent removal.

Heat transfer from the vessel walls to the granulation bed is governed by

$$Q = hS\Delta T \quad (3.1)$$

where  $Q$  = the energy exchange,  $h$  = the exchange coefficient,  $S$  = the contact surface of the heated wall, and  $\Delta T$  = the temperature difference between the contact wall and the granulation.

The rate of drying can be facilitated either by increasing the contact area between the granulation and the vessel walls (which can be achieved by agitating the product or utilizing a tilting bowl) or by maximizing the temperature differential between the vessel walls and product (either through increasing the jacket temperature or through maintaining the temperature of the product as low as possible during processing).

Eq. 2 is a simple relation that may be of some value for the scaling-up of processes using conductive heating (5)

$$t_b/t_a = (A/V)_a(A/V)_b \quad (3.2)$$

where  $t$  = drying time,  $A$  = heat transfer surface ( $\text{m}^2$ ),  $V$  = vessel working volume ( $\text{m}^3$ ),  $a$  = refers to pilot scale, and  $b$  = refers to production scale.

This relation accounts for the ratio of the surface area of the jacketed bowl and the volume of the product requiring drying.

### 3.2. Vacuum Drying

Single-pot processors using vacuum drying may be considered if the product must be dried at low temperature ( $<40^\circ\text{C}$ ), if solvent recovery is required, or if the potential for explosion is high. A vacuum is maintained within the vessel, thereby lowering the temperature at which the granulating solvent evaporates. Because vapors are removed from the processing bowl, vacuum drying provides a convenient means for solvent recovery.

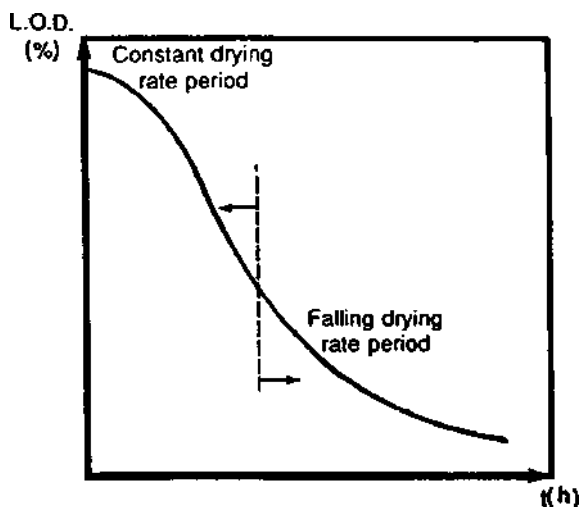
De Smet (6) has discussed the theory, advantages, and limitations of vacuum drying. Aqueous granulations require a large amount of energy during drying, which is generally supplied by the transfer of heat through conduction from the jacketed bowl to the product. The amount of energy required for water removal is dependent on the level of vacuum applied to the vessel and the osmotic pressure of dissolved substances. As additional material dissolves in the water, the osmotic pressure increases and additional energy is necessary to drive off the water. Therefore, as the material becomes drier, the amount of energy necessary to evaporate the water increases, and the rate of evaporation slows down. Processing times in vacuum driers are often long, owing to the limited contact of the granulation with the heat from the jacketed walls, and the slow rate of evaporation of the solvent from the interior of the granules.

The drying rate of the vacuum component is dependent on the following relation:

$$V = ks\Delta P \quad (3.3)$$

where  $V$  = evaporation rate,  $k$  = rate coefficient,  $s$  = total surface of granules, and  $\Delta P$  = the vapor pressure difference between the granules and the surrounding space.





**Figure 4** Typical curve for vacuum drying. (Courtesy of *Manufacturing Chemist*).

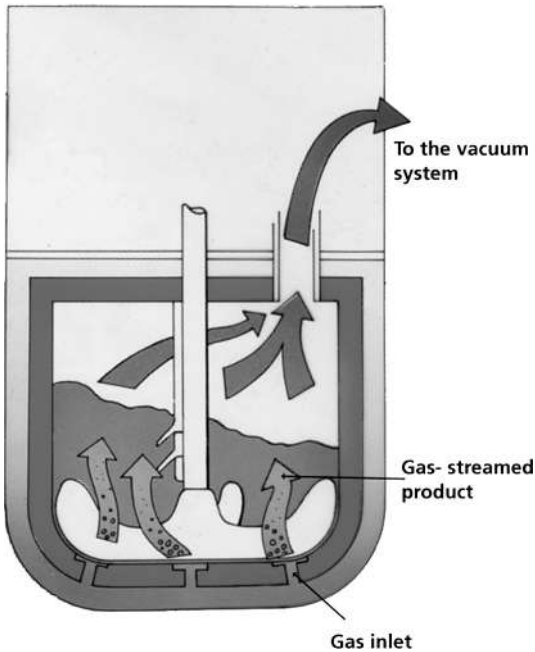
The rate of drying can be facilitated by increasing the level of vacuum (i.e., decreasing the pressure within the bowl) to increase the differential between granule and bowl vapor pressure. Figure 4 is a typical drying curve for a vacuum-drying process. When moisture content in the granulation is high, the rate of drying is constant because evaporation of solvent from the product surface readily occurs. As the level of moisture on the granule surface decreases, water must migrate from the interior of the granule before evaporation. As a result, the rate of evaporation progressively decreases.

During vacuum-drying processes, one should be aware of various problems that could arise. For example, granule damage may occur owing to excessive attrition as the bed is agitated during drying. Vacuum systems should contain adequate filtering or blowback to prevent the loss of granulation “fines” through the vacuum line, which may compromise the drug uniformity within the processed batch.

A condenser positioned between the processor and vacuum pump, should always be used, especially for granulations manufactured using organic solvents. The condensate must be sufficiently cooled to prevent it from being released into the atmosphere. Also, filters may become blocked owing to condensation forming on the filter or the entrapment of solid particles. Blockage of the filters reduces the level of vacuum that can be pulled on the bowl and excessively strains the pump itself.

### 3.3. Gas-Assisted Vacuum Drying

Accelerating the drying process in vacuum driers is often limited by characteristics of the product or equipment. Bowl temperature is generally limited by the physico-chemical stability of the product, which can limit the use of higher temperatures to expedite drying. Increasing the contact area between the product and the vessel is difficult without significantly altering the design of the equipment. Excessive agitation of the product can lead to considerable granule attrition, which can lead to poor granulation flow and compression properties.



**Figure 5** Gas-assisted vacuum-drying principle. (Courtesy of Collette NV, Belgium.)

Gas-assisted vacuum drying improves the efficiency of single-pot processors that use vacuum drying by continuously introducing a small stream of gas through the granulation to facilitate solvent removal. Drying continues to be performed at lower temperatures (compared with tray and fluid-bed drying), but at shorter-processing times than vacuum drying alone.

The gas may be introduced into the unit through openings in the bottom of the vessel or through the mixing blades (Fig. 5).

Compressed air or nitrogen (mixed with or without air) is the commonly used gas for these units. The rate of gas flow and the level of vacuum applied to the bowl can be adjusted for a specific product to produce optimal drying conditions.

The introduction of gas into a vacuum chamber facilitates the drying process through several actions. The constant flow of gas through the product improves the transport of moisture from the product to the vacuum-solvent recovery system (7). Introducing gas into the bowl also increases the vapor pressure driving force (8). The pressure gradient across the vessel is increased, resulting in a reduction in the rate at which water molecules recombine, producing a net increase in the rate of evaporation. This causes the product temperature to be reduced, which increases the temperature differential between the granules and the bowl wall. The gas also reduces drying time by increasing the heat transfer coefficient from the bowl to the bed. In addition to improving the heat transport through the bed, the gas can reduce or eliminate product sticking to the sides of the vessel walls because it improves flow and dries the particle surfaces more quickly. As the vessel wall is the only notable source of drying energy this technology is best used in the case of:

- Small batch sizes (good surface volume ratio)
- Heat-insensitive materials (allows to operate a higher wall temperature)
- Organic solvents (requires only a fraction of the energy water needs for evaporation).

Additionally, the boiling temperature corresponding to the actual vacuum level is much lower for organic solvents than for water, generating a larger temperature difference between product bed and vessel.

### 3.4. Microwave Vacuum Drying

High-shear granulators with microwave vacuum-drying capabilities provide the fastest drying rates in the family of single-pot processors. Microwave drying is based on the absorption of electromagnetic radiation by dielectric materials, the theory of which has been extensively described (9–11). Microwaves are a form of electromagnetic energy similar to radio waves, the frequencies of which fall between 300 and 3000 MHz (between radio and optical waves, (Fig. 6). The two frequencies allocated for domestic, scientific, medical, and industrial purposes are 915 and 2450 MHz. Pharmaceutical processors generally use 2450 MHz, because this frequency is more desirable when used in conjunction with vacuum. Single-pot processors incorporating microwave drying are constructed of stainless steel because metal is a common reflector of microwave energy and contains the energy within the processing chamber. Teflon is essentially inert to microwaves, making it a suitable material for components required in the processing bowl (e.g., spray lance and temperature probe).

Energy absorption of materials exposed to microwaves is described by Eq. 4 (10,11):

$$P = 2\pi f V^2 E_0 E_r \tan \delta \quad (3.4)$$

where  $P$  = the power density of the material ( $\text{W}/\text{m}^3$ ),  $f$  = frequency (Hz),  $V$  = voltage gradient ( $\text{V}/\text{m}$ ),  $E_0$  = dielectric permmissivity of free space ( $8.85 \times 10^{-12} \text{ F}/\text{m}$ ),  $E_r$  = dielectric constant of the material, and  $\tan \delta$  = loss tangent.

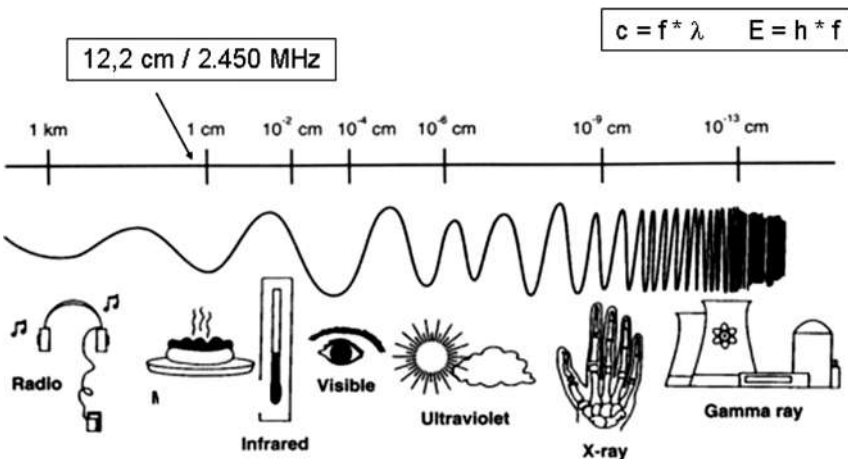


Figure 6 The electromagnetic spectrum.

For a constant electric field strength  $V$  the term  $(2\pi fV^2E_0)$  is constant. Therefore, the power absorbed is proportional to the term  $(E_r \tan \delta)$ , called the loss factor, which is a relative measure of how easily a material absorbs microwave energy.

Various materials commonly used in pharmaceutical formulations have low loss factors and only absorb microwave energy at high field strengths. Solvents used in the granulation process (water, ethanol, isopropanol, and such), however, possess high loss factors relative to the pharmaceutical powders (10). The dipolar component of the solvents couples with the high-frequency electromagnetic field producing high heating rates for the solvent, resulting in its evaporation and subsequent removal from the processing chamber. Table 1 lists the loss factors for various components in a typical pharmaceutical granulation (12).

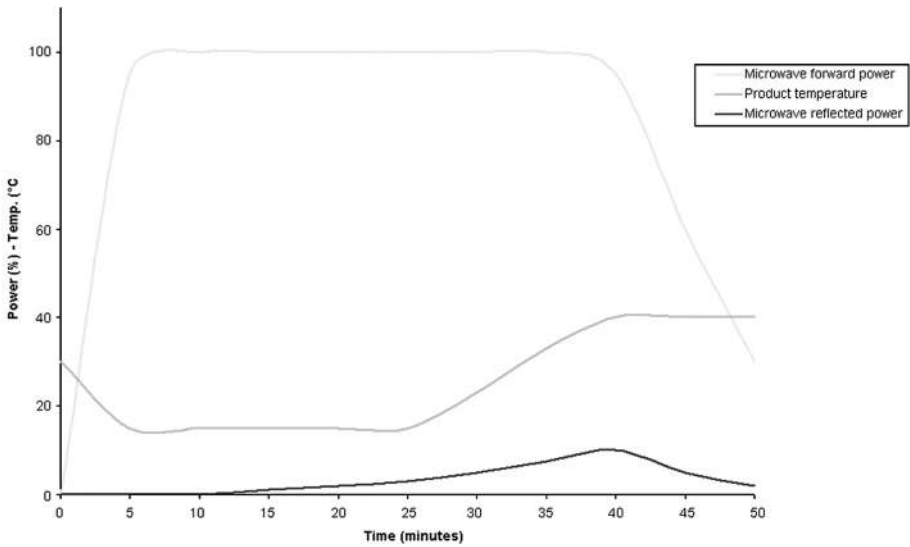
Lucisano and Moss (13) performed a study in which a microwave drying process was conducted in two different processors, one using fixed-output magnetrons and the other using a variable-power magnetron. The unit using fixed-output magnetrons had difficulty obtaining low moisture levels ( $<0.3\%$ ) because the E-field safety set point was exceeded when the moisture was  $<1\%$ . This problem did not occur for the unit using the variable-power magnetron because forward power was reduced as the E-field increased. During the late stages of drying, the unit was primarily functioning as a vacuum dryer, as the amount of microwave energy being introduced into the bowl was minimal. Nowadays, most microwave driers use the variable output magnetrons.

The use of vacuum during microwave drying lowers the temperature at which the solvent volatilizes, thereby limiting the temperature to which the material is exposed. For example, at a vacuum of 45 mbar, water-based granulations will dry at  $\approx 31^\circ\text{C}$ . Once most of the water is removed from the process, the temperature of the material will rise as components in the mixture with lower loss factors start to absorb the microwaves. If too much vacuum is applied to the system, there is a potential for granule breakdown owing to the excessive pressure between the core and the surface of the granules. Microwaves are typically applied in a vacuum range of 30–100 mbar. Introducing microwave into a vacuum  $<30$  mbar risks ignition of the surrounding atmosphere, a condition known as “arcing.”

Control of the drying process is achieved through the simultaneous measurement of product temperature, forward power, and reflected power. Figure 7 depicts the level of microwave forward power, microwave reflected power, and product temperature at various times during the drying process. During the initial stage, the product temperature remains relatively constant as the free solvent is preferentially evaporated, and the reflected power remains relatively low. The amount of vacuum applied to the bowl, and to a lesser extent the bowl jacket temperature, will affect the actual product temperature observed. As drying progresses at a constant rate of forward power, the amount of absorbed energy decreases as the material dries, thereby increasing the amount of free energy. As the free energy increases, a corresponding increase in the reflected power is also observed.

The rise in reflected power is accompanied by an increase in product temperature, which is simultaneously monitored while the magnetron output power is reduced. This is necessary because the loss factors for some pharmaceutical components are so small that very low moisture can be achieved before the temperature rises. For such materials, the reflected power can rise sharply once most of the solvent has evaporated, resulting in significant temperature gains.

The rise in temperature and reflected power signifies that the end of the drying process is approaching. Several factors, such as the loss factors of the formulation



**Figure 7** Relationship between microwave forward power, microwave reflected power, and product temperature during microwave vacuum drying.

components, the microwave power, and the solvent retention properties of the solids influence the point at which the previous relation will occur.

For example, lactose has a low loss factor and shows a sharp rise in reflected power, followed by a slow temperature rise. Conversely, starch has a high loss factor and demonstrates a fast temperature rise followed by a slow rise in reflected power.

## 4. OTHER PROCESSES AND APPLICATIONS

Because of the different technologies incorporated into a single-pot processor, it is capable of executing many different processes, apart from the standard wet granulation and drying process, while small modifications or additional options can extend the flexibility even further.

This chapter discusses some of the possible “special” processes and applications in a single-pot processor. Although many of these processes are used in the pharmaceutical industry, scientific literature on them is rare. The main reason for this is that many of these processes were developed by the pharmaceutical industry as product-specific solutions. This does not imply, however, that these processes cannot be used more widely.

### 4.1. Melt Granulation

Melt granulation is a process in which the binder solution of the standard wet granulation process is replaced with a meltable binder such as a wax or polyethylene glycol (PEG), which is generally added in solid form, and melted during the process by adding the necessary energy.

The most common production technique for melt granulation uses extruders, but melt granulation in a high-shear mixer has also been extensively described in the literature.

In this process, the necessary energy to melt the binder is provided either by the mixer arm (mainly in laboratory-scale equipment) or by a heated jacket (14–16).

If the meltable binder used absorbs microwaves, however (such as PEG for example), using a single-pot processor equipped with microwave drying can present major time-savings to the production process.

Providing the melting energy by the impeller or the heated jacket can be a very time-consuming process, especially in production-scale equipment. Microwaves (as explained earlier) are an instant source of energy that penetrates into the product and can provide the energy faster and immediately where needed.

In a comparison between the use of the heated jacket to melt the binder and the use of the heated jacket supplemented with microwaves, the latter method not only proved to be more than twice faster in melting the binder used (PEG 3000), but also the granulation step was reduced threefold (17).

At this moment, there is no literature available about other meltable binders in combination with microwaves.

However, the results from the previously mentioned study show that it is worthwhile to consider a single-pot processor for the production of melt granulations.

Another step where a single-pot processor can present a major advantage compared to the standard production techniques, and especially compared to the process in a high-shear mixer, is the cooling step. To achieve a stable “dry” granule from a melt granulation process, the product needs to be cooled down to room temperature. In a high-shear mixer, the cooling process is done by circulating cold water or a glycol–water mixture in the bowl jacket. As the contact surface between the product and the jacket is limited, the cooling process generally takes a long time. If the process is executed in a single-pot processor equipped with a gas-assisted vacuum-drying system, this system can be used to pass cold air or even liquid nitrogen through the product to aid the cooling process and reduce the cooling time considerably. If liquid nitrogen is used, even a fivefold reduction of the cooling time is achievable (17). A related chapter in this book should be consulted to gain more understanding of melt granulation.

## 4.2. Pellet Production

For the production of spheres or pellets, in most cases an extrusion/spheronization process is used.

There are, however, many references in scientific literature detailing the production of pellets using a high-shear mixer, most of which concern melt pelletization (15–21). Taking into account the explanations given earlier on melt granulation, a single-pot processor can, of course, also be used for this process for the same reasons.

Also, for other pelletization processes, not using meltable binders, the use of a single-pot processor can be advantageous. In scientific literature, there are some references describing the use of a high-shear mixer for such processes (22,23), but so far none can be found about single-pot processors. Nevertheless, a standard pellet formulation often contains microcrystalline cellulose, which needs high water content to obtain a good granule/pellet quality. Drying the pellets is always a part of the production process. The advantage of a single-pot processor is that the whole process of pelletization and drying can be executed in the same equipment, making



**Figure 8** Example of a special pelletizing mixer arm. (Courtesy of Collette NV, Belgium.)

product transfers redundant and thereby reducing the risk of product loss and contamination and enhancing containment and operator safety.

To enhance the pelletization/spheronization process, many vendors of high-shear mixers/single-pot processors offer special mixing tools for producing pellet-like granules. Depending on the geometry of the equipment, this special mixing tool has either more (up to six) or less (up to two) mixing blades than a standard mixing tool, which generally has three mixing blades (Fig. 8). All special pellet-mixing tools have, however, the same purpose: to simulate the product behavior in a spheronizer and enhance the spheronization process that occurs in the mixer.

### 4.3. Effervescent Production

The production of effervescent tablets is first of all a conventional solid dosage form manufacturing process, which has to be taken into consideration, due to the special characteristics of the product and some unusual features.

For granulation of effervescent products, many different production techniques can be used, ranging from dry granulation methods over two-step granulation (granulating acid and alkali phase separately) to one-step granulation using water or organic solvents.

For the one-step granulation methods, the use of a single-pot processor offers many benefits. Apart from the overall benefit of eliminating product transfer between a granulator and a dryer, a single-pot processor allows easy solvent recovery by condensation in case organic solvents are used as granulation liquid, compared to the quite complex system for the exhaust gas treatment required for a fluid-bed dryer.

When water is used as granulation liquid for effervescent, the effervescent reaction will start and cause a chain reaction. The critical point in such a process is to stop this reaction at the correct time by evaporating the water created by this reaction. In a single-pot processor, this can be very easily and accurately achieved by switching on the vacuum-drying system (possibly supplemented with gas-assisted drying or microwave drying) (24).

#### 4.4. Crystallization

Although a high-shear mixer/single-pot processor is mainly intended for powder processing, there is a possibility of executing crystallization or recrystallization processes in this type of equipment as well. Starting either from a solution or from a powder, which is dissolved in a suitable solvent, the speed of the drying process can be controlled to achieve the desired crystallization process. Using vacuum drying only, the drying process will be slow and gradual. Temperatures during this process will remain low, creating an environment for slow crystal growth. When microwaves are used for drying, the process will be considerably faster and the temperature of the product will most likely be higher than under “pure” vacuum conditions. The crystals that result from such a crystallization process will have different characteristics from those from the vacuum-drying process. When choosing the appropriate settings for the drying/evaporation process, combining vacuum and microwave drying, crystals with specific properties can thus be obtained.

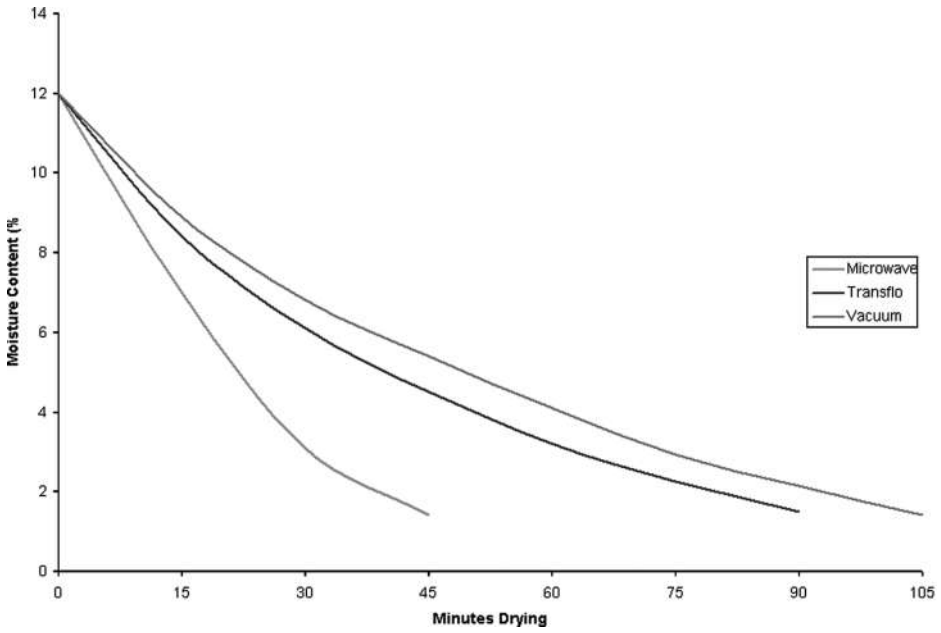
The main advantage of executing a (re) crystallizing process in a single-pot processor is that the possibility exists of granulating the product at the same time by varying the mixer speed during the drying process. The resulting product will be suitable for tableting without the necessity of executing other processing steps (apart from lubrication).

### 5. SCALE-UP OF DRYING PROCESSES

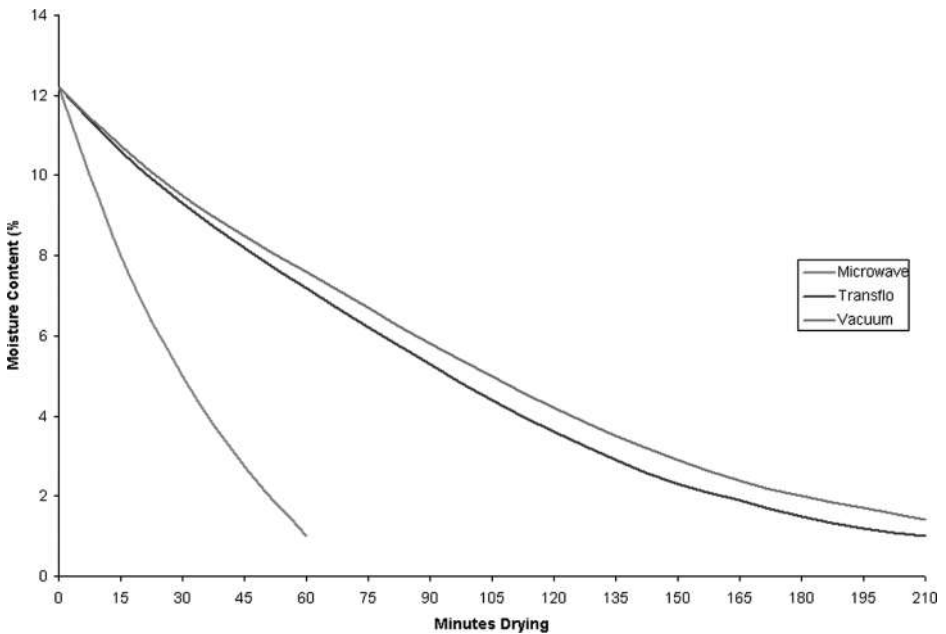
Because the rate of solvent removal during vacuum drying is dependent on a favorable surface area/volume ratio, the drying time in a vacuum processor often increases substantially during scale-up as described by Formula (3.2). Microwave vacuum drying is relatively insensitive to the surface area/volume ratio and does not suffer the same inefficiency as vacuum drying during transition from pilot to production scale. Pearlszig et al. reported successfully scaling a microwave vacuum-drying process for a moisture-sensitive formulation that required a drying end point of  $< 0.2\%$  (25). The drying time remained within a 30–45 min range throughout the scale-up from 15 kg (Vactron.75) to 300 kg (Vactron.600), whereas the time for vacuum drying increased threefold. After additional scale-up to 600 kg in a Vactron.1200, the drying time rose slightly to a 50–55 min range. Poska also reported attaining equivalent drying times when scaling up in Spectrum processors ranging from 65 to 300 L bowl size (26). [Figure 9](#) compares typical drying curves for lactose–starch granulation prepared in single-pot processors using vacuum drying, gas-assisted vacuum drying, or microwave vacuum drying. Although not as rapid as microwave vacuum drying, gas-assisted vacuum drying can decrease the drying time by up to 50% compared with that of vacuum drying alone. As the wall of the vessel is the only source for drying energy, also in this case the scale is of major importance for the drying time (27).

When performing feasibility trials on a development- or pilot-scale single-pot processor, it is important to be aware of the maximum energy input capacity of the corresponding production-scale processor. In [Figures 9 and 10](#), the drying times for each drying method in a pilot- and production-scale single-pot processor are shown. While for processors equipped with microwaves, the drying time is relatively independent of the scale, a significant increase in drying time is observed for vacuum- and gas-assisted vacuum-drying processes.





**Figure 9** Comparison of drying curves for different modes of drying in a 75 L UltimaPro™. (Courtesy of Collette NV, Belgium.)



**Figure 10** Comparison of drying curves for different modes of drying in a 600 L UltimaPro™. (Courtesy of Collette NV, Belgium.)

## 6. CLEANING

As a single-pot processor is often used for highly potent products, or more generally for contained production, it is important that also cleaning of the machine can be executed in a contained, automated fashion to eliminate the risk of operator exposure to the active product.

All single-pot processors on the market nowadays are equipped with a more or less extensive clean-in-place system. Vendors have made a great effort to optimize their design enabling easy cleaning in place, which can be validated (3). The focus has been to eliminate any dead spots in the equipment where the cleaning water cannot reach and including cleaning spray balls in critical product contact areas such as the product filter and discharge valve.

Drying of the single-pot processor after the cleaning cycle to prepare the equipment for the next batch can be done using the system's own vacuum-drying system and jacketed bowl, making a separate drying unit redundant.

A nice case study of an evaluation of a clean-in-place system on a pilot-scale single-pot processor is given in Ref (3). In this study it was proved that a complete changeover from one product to the next can take place in <2 hr.

## 7. PRODUCT STABILITY

The stability of pharmaceutical granulations dried by microwaves is comparable with that provided by alternative methods. Microwaves are nonionizing and do not possess the amount of energy required for the formation of free radicals or the liberation of bound water conditions that foster product instability (Fig. 6).

Since the introduction of microwave drying at the end of the 1980s, numerous new and supplemental drug applications that include the use of microwave vacuum drying of wet granulations have been approved by the Food and Drug Administration (FDA). We are unaware of any instance in which the FDA required additional stability or analytical testing beyond that normally required for other methods of manufacture. Mandal (28), Moss (29), and others (26,30) have also published or presented data showing the comparability of the physicochemical characteristics of granulation dried in microwave processors vs. tray driers and fluid-bed driers.

When microwaves were first introduced, some authors (31) concluded that microwave drying could not be generally recommended because of the inability to control the microwaves after they enter the drying cavity and the risk of unacceptable thermal damage to active substances with high loss factors (i.e., high dielectric constants). The routine production of pharmaceutical products by several installations of single-pot processors using microwave vacuum drying indicates that their general concerns can be addressed by the proper selection of formulation components and process parameters.

## 8. REGULATORY CONSIDERATIONS

Single-pot processors combine established technologies into a single piece of equipment and, in general, deserve no special regulatory consideration when using them to develop a new product or to manufacture an approved product. Robin and colleagues (4) surveyed eight European regulatory agencies in 1992 to determine the

implications of converting from fluid bed drying to microwave vacuum drying within a single-pot processor. The majority of the agencies required only process validation data and three suggested limited stability data (up to 6 months of accelerated data). These requests were no different from those expected for similar types of manufacturing changes (i.e., change in process or equipment).

Manufacturers considering converting to a single-pot process for an immediate-release, solid oral dosage form (tablets, capsules, or the like) with an approved manufacturing process should consult their appropriate regulatory agencies governing the practices they use to manufacture their products. For drug products sold in the United States, manufacturers should refer to FDA's SUPAC IR Guidance document (32), which addresses scale-up and postapproval changes for marketed products. This document describes the levels of change that may be made in a manufacturing process and equipment. It outlines the chemistry, manufacturing, and control tests and documentation for each level of change as well as the appropriate regulatory filing (Annual Report, Prior Approval Supplement, or other).

For example, a tablet formulation is currently granulated using a high-shear granulator and dried in a tray drier. A drug manufacturer wishes to replace this process with a single-pot processor that incorporates high-shear granulation and gas-assisted vacuum drying. This conversion would be viewed as a change in equipment to a different design and different operating principles (defined as a Level 2 Equipment Change in the SUPAC IR Guidance document). Such a change requires the manufacturer to submit a Prior Approval Supplement with up to three batches with 3-months accelerated stability data (depending on the duration of commercial experience with the product). The submission would also require updated batch records including the new equipment, and the generation of multipoint dissolution profiles. The requirements for this conversion are, however, the same as those for a conversion of a tray drier to a fluid-bed drying process.

## 9. VALIDATION OF SINGLE-POT PROCESSORS

Because single-pot processors combine standard engineering approaches into a single processor, their validation should pose no special problems. Other sources adequately describe the validation of granulating and drying processes (33), although validation of the microwave drying system and the approach to process control of drying end point deserves special mention.

For operational qualification of microwave components, such as forward and reflected power, and arc detection, we suggest that customers contact the vendors because of the specialized nature of microwave systems. The cost associated with the calibration equipment is difficult to justify, and microwave systems should operate reliably following proper setup and qualification and require no more periodic maintenance than other granulation approaches.

When microwave processors were first introduced, there was the expectation that E-field would be a reliable indicator of the drying end point. With experience, users found that the E-field tends to be too variable, and now view it primarily as a safety feature monitoring the microwave field within the drying cavity. Most microwave driers on the market today do not even include E-field monitoring any more, because of the difficulties with validation of this system.

Product temperature, time, cumulative forward power, and reflected power are proving to be more reliable indicators of drying end point with verification by some

in-process control that directly measures the moisture content of a product sample. The industrial processes in operation today all use one of these approaches for end-point determination.

With the pharmaceutical industry moving toward the use of process analytical technology (PAT), however, the equipment vendors are also investigating the possibility of applying this technology to single-pot processors and thereby eliminating the necessity of taking product samples. The first single-pot processors with PAT will undoubtedly be introduced into the market shortly.

## 10. CONTROL SYSTEMS AND DATA ACQUISITION SYSTEMS

Users of single-pot processors may use one or all of its processing features (mixing, granulating, drying, or other). The accompanying data acquisition system must collect, display, and record the relevant processing conditions and granulation behavior for each cycle. The degree of sophistication of the system may depend on the venue in which the processor is used.

In a development setting, the sequence of cycles is often interrupted to collect samples for analysis, and the user is interested in capturing as much information as possible to assist in defining a suitable processor for a particular formulation. In many cases, the control system for a development environment can be limited to a manual control system. The data acquisition system, however, needs to be more sophisticated to allow registration of all relevant processing data.

In production, the manufacturing sequence and process parameters are predefined and validated, and information needs are reduced to monitoring critical parameters. In these settings, an automatic control system with recipes to reduce operator interventions is indispensable. The data acquisition system may or may not be as sophisticated as for the development settings, depending on the requirements for data in the batch records.

For the purposes of trouble-shooting and trend analysis of production operations, however, the information requirements of development and production converge, and data acquisition systems for single-pot processors should seek to address the needs of both types of users.

All data acquisition systems are considered to generate electronic records. If these electronic records are used as batch documentation, the acquisition system needs to be compliant with FDA 21 CFR part 11.

Most vendors have addressed these issues by including password control, audit trails, and point verification systems (Fig. 11).

## 11. SAFETY

The primary safety concern during the granulation and drying processes is the prevention of explosions. Bulk powder, dust clouds, and flammable vapors, all have the potential to explode. Adequate grounding and ventilation during loading and discharging of the vessel and controlling the various processing conditions can reduce the risk of explosion.

In Europe, all equipment used in a potentially explosive atmosphere needs to be compliant with the ATEX guidelines (34).

Two approaches are generally taken toward explosion protection in single-pot processors. One consists in removing oxygen from the processing chamber and



in any facility that uses microwave drying. This will demystify any unfounded concerns about the technology and foster a rational approach to a sound safety and maintenance program.

## 12. CONCLUSION

Over the last 30 years since its introduction, single-pot processing has developed into a mature and generally accepted production technique.

Even if the technique historically was often used because of its specific advantages for effervescent production, potent compounds, organic solvents, or multiproduct facilities, practice has shown that single-pot processing is also attractive for standard pharmaceutical solid dosage production.

## REFERENCES

1. Van Vaerenbergh G. The influence of a swinging bowl on granulate properties. *Pharm Technol* 2001; 13(3):36–43.
2. Lucisano LJ, Poska RP. Microwave technology-fad or the future. *Pharm Technol* 1990; 14:38–42.
3. Van Vaerenbergh G. Cleaning validation practices using a one-pot processor. *Pharm Technol. Europe*. Feb 2004.
4. Robin P, Lucisano LJ, Pearlszig DM. Rationale for the selection of a single pot manufacturing process using microwave/vacuum drying. *Pharm Technol* 1994; 18:28–36.
5. Bellini G, Pellegrini L. Non adiabatic drying. In: Goldberg E, ed. *Handbook of Downstream Processing*, Chapman & Hall, 1993.
6. De Smet P. Vacuum drying. *Manuf Chem Mar* 1989; 37–39.
7. LB Bohle, Inc. Technical Report. Granulation and Drying with SYSTEM-VAGAS. Bristol, PA: LB Bohle, Inc.
8. Niro-Fielder Ltd. Technical Report. AEROVAC System, Accelerated Vacuum Drying. Eastleigh, Hampshire, U.K.: Niro-Fielder Ltd.
9. Metaxas AC, Meredith RJ. *Industrial Microwave Heating*. London: Peter Peregrines, 1983.
10. Doyle C, Cliff MJ. Microwave drying for highly active pharmaceutical granules. *Manuf Chem Feb* 1987; 23–32.
11. Waldron MS. Microwave vacuum drying of pharmaceuticals: the development of a process. *Pharm Eng* 1988; 8:9–13.
12. Poska RP. Microwave processing: the development experience revisited. *Proceedings of International Society of Pharmaceutical Engineers Congress*, September, 1992.
13. Lucisano U, Moss RA. Vacuum drying vs. microwave-vacuum drying in three pilot-scale single pot processors using sodium acid pyrophosphate as the model granulation. *AAPS Annual Meeting*, San Antonio, TX, Nov 15, 1992.
14. Schaefer T. Melt Agglomeration with Polyethylene Glycols in High Shear Mixers. Ph.D. thesis, The Royal Danish School of Pharmacy, Copenhagen, 1996.
15. Schaefer T, Holm P, Kristensen HG. Melt pelletisation in a high shear mixer. I. Effects of process variables and binder. *Acta Pharm Nordica* 1992; 4:133–140.
16. Schaefer T, Mathiesen C. Melt pelletisation in a high shear mixer. IX. Effects of binder particle size. *Int J Pharm* 1996; 139:139–148.
17. Van Vaerenbergh G. Melt granulation with polyethylene glycol in a one-pot processor. *Pharma*. In press.

18. Heng PW, Wong TW, Chan LW. Influence of production variables on the sphericity of melt pellets. *Chem Pharm Bull (Tokyo)* 2000; 48:420–424.
19. Hamdani J, Moës AJ, Amighi K. Development and evaluation of prolonged release pellets obtained by the melt pelletization process. *Int J Pharm* 2002; 245:167–177.
20. Thies R, Kleinebudde P. Melt pelletisation of a hygroscopic drug in a high shear mixer. Part 1. Influence of process variables. *Int J Pharm* 1999; 188(2):131–143.
21. Voinovich D, Moneghini M, Perisutti B, Franceschinis E. Melt pelletization in high shear mixer using a hydrophobic melt binder: influence of some apparatus and process variables. *Eur J Pharm Biopharm* 2001; 52(3):305–313.
22. Vonk P, Guillaume CPF, Ramaker JS, Vromans H, Kossen NWF. Growth mechanisms of high-shear pelletisation. *Int J Pharm* 1997; 157(1):93–102.
23. Ramaker JS, Albada Jelgersma M, Vonk P, Kossen NWF. Scale-down of a high-shear pelletisation process: flow profile and growth kinetics. *Int J Pharm* 1998; 166(1):89–97.
24. Stahl H. Manufacturing effervescent tablets. *Pharm Technol* 2003; 15(4):25–28.
25. Pearlszig DM, Robin P, Lucisano LJ. Simulation modeling applied to the development of a single-pot process using microwave/vacuum drying. *Pharm Technol* 1994; 18:44–60.
26. Poska R. Integrated mixing granulating and microwave drying: a development experience. *Pharm Eng* 1991; 11:9–13.
27. Stahl H. Single pot systems for drying pharmaceutical granules. *Pharm Technol Eur* 2000; 12(5):23–34.
28. Mandal TK. Evaluation of microwave drying for pharmaceutical granulations. *Drug Dev Ind Pharm* 1995; 21:1683–1688.
29. Moss RA. Demonstration-microwave/vacuum drying of pharmaceuticals. AAPS Annual Meeting, Washington, DC, Nov 17, 1991.
30. Van Scoik K. Microwave vacuum processing in the Vactron 300. AAPS Annual Meeting, Washington, DC, November 1991.
31. Duschler G, Carius W, Bauer KH. Single-step granulation method with microwaves: preliminary studies and pilot scale results. *Drug Dev Ind Pharm* 1995; 21:1599–1610.
32. Food and Drug Administration. Immediate release solid oral dosage forms: scale-up and postapproval changes: chemistry, manufacturing, and controls; in vitro dissolution testing; in vivo bioequivalence documentation; guidance. *Fed Reg* 1995; 60:61638–61643.
33. Berry IR, Nash eds. *Pharmaceutical Process Validation*. New York: Marcel Dekker, 1993.
34. Directive 94/9/EC of the European Parliament and the Council of 23 March 1994 on the approximation of the laws of the Member States concerning equipment and protective systems intended for use in potentially explosive atmospheres.
35. Performance Standards for Microwave and Radio Frequency Emitting Products. 21 Code of Federal Regulations, Part 1030. Washington, DC: General Services Administration, April 1, 2003.
36. IEEE Standard for Safety Levels with Respect to Human Exposure to Radio Frequency Electromagnetic Fields, 3 kHz to 300 GHz—Supplement 1999 (IEEE C95.1–1999). New York: Institute of Electrical and Electronics Engineers.

# 11

## Extrusion/Spheronization as a Granulation Technique

**Ketan A. Mehta**

*RÖHM Pharma, Degussa Corp., Piscataway, New Jersey, U.S.A.*

**Gurvinder Singh Rekhi**

*Elan Drug Delivery Inc., Gainesville, Georgia, U.S.A.*

**Dilip M. Parikh**

*Synthon Pharmaceuticals Inc., Research Triangle Park, North Carolina, U.S.A.*

### 1. INTRODUCTION

Extrusion/spheronization is a multiple step process capable of making uniformly sized spherical particles. The process is now being widely utilized in the pharmaceutical industry. This is the revision of the original chapter written by D. Erkoboni (1). As a pharmaceutical dosage form, pellets are defined as small, free flowing, spherical, or semispherical units made up of fine powders or granules of bulk drugs and excipients by variety of processes, extrusion and spheronization being one. It is primarily used as a method to produce multiparticulates for immediate and controlled release applications. The major advantage over other methods of producing drug-loaded spheres or pellets is the ability to incorporate high levels of actives without producing an excessively large particle. Mehta and Kislalioglu in their study demonstrated the incorporation of a poorly soluble drug in a pellet matrix up to 40% loading via extrusion/spheronization for controlled drug delivery (2).

Though the process is more efficient than other techniques for producing spheres, it is more labor and time intensive than the more common granulation techniques. Therefore, it should be considered as a granulating technique when the desired particle properties are essential and cannot be produced using more conventional techniques. However, more recently, pharmaceutical scientists worldwide have been able to use this method more easily due to advances in extrusion/spheronization equipment engineering, thus making it simple to use. Pellets offer scientists a great deal of development flexibility. Chemically incompatible ingredients, for instance, can be incorporated into single capsule using two pellet types each containing one of the incompatible ingredients. Pellets of different release characteristics can be combined to achieve the desired release pattern of the active ingredients. Pellets are characterized by a low surface area-to-volume ratio compared with powder or



granules, which provides excellent coating substrate. Typically, pellets range in diameter between 0.25 and 1.5 mm. Pellets are normally filled into hard gelatin capsules, or eventually compressed into tablets which disintegrate into individual pellets after oral intake.

Spheronization is a process invented by Nakahara in 1964. The patent describes a "Method and Apparatus for Making Spherical Granules" from wet powder mixtures (3). The equipment described in the patent was commercialized by Fuji Denki Kogyo Co. under the trade name Marumerizer<sup>®</sup>. The process went widely unnoticed in the pharmaceutical industry until 1970 when two articles were published by employees of Eli Lilly and Co. Conine and Hadley described the steps involved in the process including (a) dry blending, (b) wet granulation, (c) extrusion, (d) spheronization, (e) drying, and (f) screening (optional) (4). Reynolds went on to further describe the equipment and the mechanics of the process including the movement of the particles within the spheronizer (5). Both publications cite desirable product attributes that can be achieved, including good flow, low dusting, uniform size distribution, low friability, high hardness, ease of coating, and reproducible packing. Additionally, the resulting pellets offer not only technological advantages as mentioned before but also therapeutic advantages such as less irritation of the gastrointestinal tract and a lowered risk of side effects due to dose dumping and reproducibility of the drug blood levels (6). From the publication of these articles through present day the interest in extrusion/spheronization has continued to grow. The process has recently become established in industry but was primarily driven by academia in the interim. The increased popularity in recent years is, in part, due to a growing understanding of the effects of process parameters and material characteristics.

In recent times, hot-melt extrusion (HME) has gained subsequent industry and academic attention and is in the phase of further process maturity for ultimately gaining wide spread popularity. HME is somewhat widespread in the plastics industry for the production tubes, pipes, wires, and films. For pharmaceutical systems, this method has been used to prepare granules, sustained release tablets, and transdermal drug delivery systems (7). The advantage of HME is that it does not require the use of solvents and water and few processing steps are needed making the process somewhat simpler, efficient, and continuous. The disadvantage of HME is that it may use complicated know-how and typically employs high temperatures around and over 100°C as a processing requirement. However, it has been used as a method to increase the solubility of a poorly soluble drug, to taste mask a bitter drug and overall for controlled release dosage form purposes. The bioavailability of the drug substance has been demonstrated to improve when it is dispersed at the molecular level in hot-melt extruded dosage forms. Several examples of melt-extruded molecular dispersions were presented by Breitenbach and Mägerlein (8).

A recent patent (9) describes melt-extrusion process as being used to produce improved controlled release characteristics. The authors described the process which includes mixing together a therapeutically effective agent, a water-insoluble retardant, and a binder to form a homogeneous mixture, heating the mixture and thereafter extruding the mixture into strands. The strands are then cooled, reduced to the desired sizes.

The number of hot-melt extrusion patents issued for pharmaceutical systems has increased more than sixfold annually since the early 1980s, with the United States, Germany, and Japan leading the field. The field of melt extrusion technology is growing very rapidly and its use to produce films for transmucosal and transdermal drug delivery applications was presented by McGinity and Repka (10).

## 2. APPLICATIONS

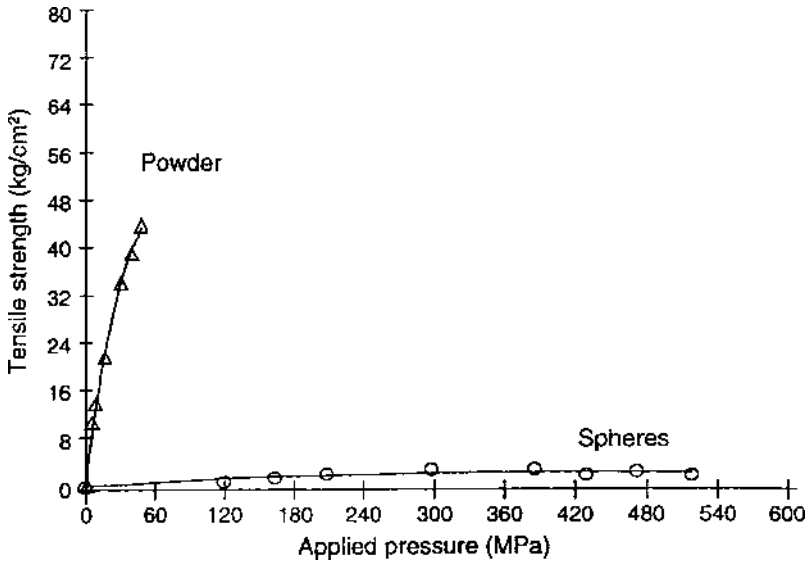
Potential applications are many including both immediate and controlled release. In a paper by Sood et al., extrusion/spheronization method was used to develop controlled release dosage forms for diltiazem hydrochloride (11). Two or more actives can easily be combined in any ratio in the same unit. These combination products can contain actives that are incompatible or have varying release profiles. Spheres can be used as a method to limit drug migration. Physical characteristics of the active ingredients and excipients can be modified to improve physical properties and downstream processing. As an example, a low-density, finely divided active can be pelletized to increase density, improve flow, and limit dusting (12). Mehta et al. showed that this technique can be used for the development of zero order controlled release drug delivery of poorly soluble drugs (13). Functional coatings can be applied easily and effectively. Dense multiparticulates disperse evenly within the gastrointestinal tract and can be used to prolong gastrointestinal transit times (14,15) or to improve tolerance of some compounds. Regardless of the application, care must be taken to achieve the required sphere or granule properties.

Spheres for controlled release coating applications will likely have significantly different physical requirements than granules for compression. A product to be coated for controlled release should have a uniform size distribution, good sphericity and surface characteristics as well as low friability. Once coated, the sphere should have the desired release characteristics. Additionally, if the coated spheres are to be compressed into tablets, they will require sufficient strength to withstand the forces of compression. Upon disintegration of the tablet, the individual spheres must retain their original release profile. Physical properties such as flow, density, friability, porosity, and surface area become important for granules intended for compression into tablets. The granules should have good deformation and bonding characteristics to form tablets having desirable physical properties. Drug release from the final dosage form must meet the target specification.

Product produced using extrusion/spheronization can range from barely shaped, irregular particles with physical properties similar to a conventional granule to very spherical particles having properties that are drastically different (16). Tableting characteristics can be modified by altering the composition of the spherical particles (17), granulating fluid (18), or the process conditions used to produce them (19). Compaction studies conducted on spheres similar to those used for controlled release applications show the bonding and densification that occur during extrusion/spheronization can alter the deformation characteristics of some materials (18). Microcrystalline cellulose (MCC), which deforms plastically in the dry powder state, exhibits elastic deformation followed by brittle fracture once spheronized (17). The deformation characteristics, coupled with the larger size particles result in reduced bonding sites and the production of weak compacts. A compaction profile of MCC and spheres prepared from MCC is shown in [Figure 1](#).

The point is not to dwell on the properties required for each application, but rather to reinforce the fact that each application will have very specific requirements. One must first understand the properties required and then tailor the process to yield the desired effects. The effects of process and formulation variables will be discussed next.

A review of the literature shows that most investigators have tried to understand small components of this process isolated from other effects. They have focused on particular formulation or process parameters. It is valuable to have



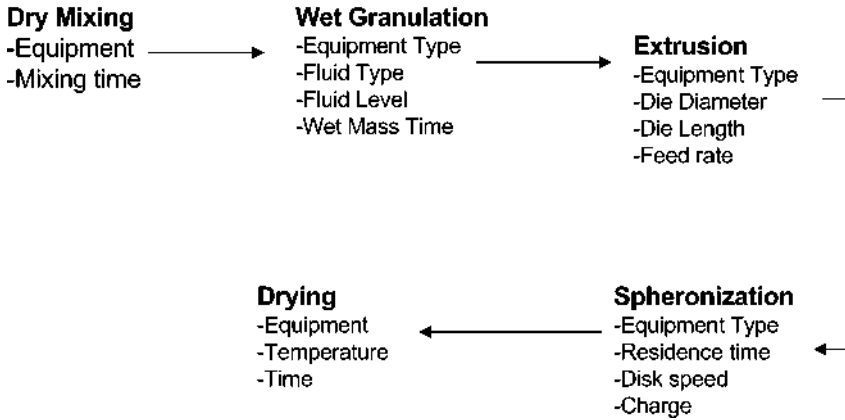
**Figure 1** Compaction profiles of microcrystalline cellulose powder and spheres. (From Ref. 17.)

a detailed understanding of the main variables; however, this approach fails to take into consideration the high degree of interaction that exists between the variables. The use of statistical experimental design is a valuable tool to understand not only the main effects but also the interactions that can have a profound effect on the characteristics of the resulting particles (20–22). Additionally, these techniques are extremely useful during product/process development to understand the effect of variables and control them to produce product having desired attributes (23). After pointing out the benefits of design methodology in this application, it should be understood that, for simplicity, much of the discussion to follow will address the various topics individually. In reality, however, they truly cannot be isolated from one another. This chapter will review and discuss the general process, equipment types, and the effect of process and formulation variables on the properties of spherical granules.

### 3. GENERAL PROCESS DESCRIPTION

Extrusion/spheronization is a process requiring at least five units of operation with an optional sixth screening step. First, the materials are dry mixed (i) to achieve a homogeneous powder dispersion and then wet granulated (ii) to produce a sufficiently plastic wet mass. The wet mass is extruded (iii) to form rod-shaped particles of uniform diameter that are charged into a spheronizer and rounded off (iv) into spherical particles. The spherical particles are then dried (v) to achieve the desired moisture content and optionally screened (vi) to achieve a targeted size distribution. The process flow diagram, shown in [Figure 2](#), has been used to show each of the process steps along with critical variables associated with them (24). The end product from each of the steps is shown in [Figure 3](#).

## Extrusion/Sphronization Process Flow Chart and Variables

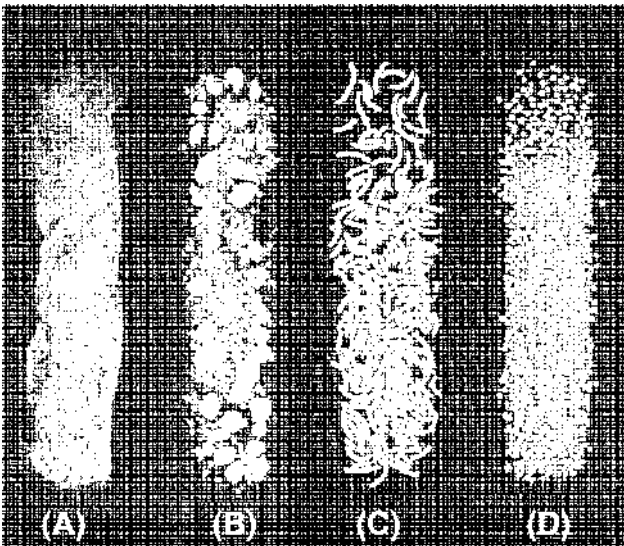


**Figure 2** Process flow chart of the extrusion/sphronization process showing the process variables for each individual step. (From Ref. 24.)

## 4. EQUIPMENT DESCRIPTION AND PROCESS PARAMETERS

### 4.1. Dry Mixing

During the first step, powders are dry mixed to achieve a uniform dispersion prior to wet granulation. It is generally carried out in the same mixer used for the granulation;



**Figure 3** Product produced by the first four extrusion/sphronization process steps. (A) Powder from dry mixing; (B) granules from granulation; (C) extrudate from extrusion; and (D) spheres from sphronization.

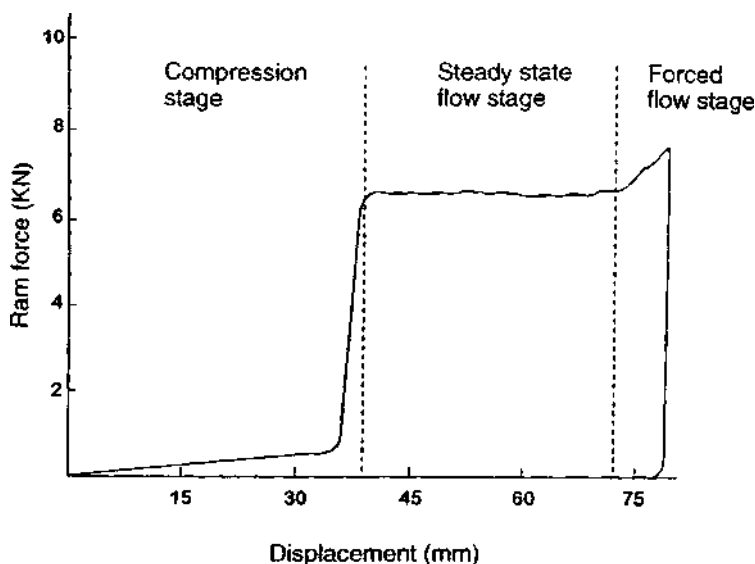
however, if a continuous granulator is used, a separate mixer is required for the dry mix. This step is typically taken for granted because wet massing follows. The uniformity of the dry mix, however, can have a significant effect on the quality of the granulation and, in turn, the spherical particles produced. An uneven distribution of materials having wide differences in properties such as size and solubility can result in localized over wetting, at least initially, during the granulation step. The more soluble and finely divided components can also dissolve and become part of the granulating fluid. The fluids, rich in soluble compounds, can either remain as overwet regions or, with continued wet massing, can be redistributed (25). Sphere uniformity (size and shape) is very much dependent on the uniform distribution and composition of the granulating fluid which include not only the solvent but also any dissolved ingredients.

## 4.2. Granulation

The second step is granulation, during which a wet mass having the requisite plasticity or deformation characteristics is prepared. With a few exceptions, this step is similar to conventional granulation techniques used to produce product for compression. It is typically carried out in a batch type mixer/granulator; however, any equipment capable of producing a wet mass, including the continuous type, can be used. Batch type processors include planetary mixers, vertical or horizontal high shear mixers, and sigma blade mixers. Examples of continuous mixers include the Nica M6 instant mixer (26) and high shear twin screw mixer/extruders (27). The high shear twin screw mixer/extruders have mixer/feeders that are capable of shearing and kneading the feed materials. Dry powders and fluids are fed in through separate ports and mixed by the action of the extruder blades and screws. The mixer/extruder is capable of being configured to customize the amount of shear and energy used in the process by changing the configuration of the mixing blades. This can have an impact on the properties of the extrudate produced (28). As with the batch processors it is critical to achieve a uniform level of fluid within the wet mass. The proper fluid/solids ratio is accomplished by maintaining a steady powder and fluid feed into the mixer/extruder. Both are critical; however, the powder feed is the most problematic. Small variations in feed rates can cause significant shifts in the moisture content of the granulation and, therefore, the quality of the spherical particles produced.

The two major differences in the granulation step, as compared to typical granulations for compression are the amount of granulating fluid required and the importance of achieving a uniform dispersion of the fluid. The amount of fluid needed to achieve spheres of uniform size and sphericity is likely to be greater than that for a similar granulation intended for tableting. Instruments such as a ram extruder (29) and a torque rheometer (30) have been used to characterize the flow characteristics of granulations for use in extrusion/spheronization. They are useful tools in quantifying the rheological effect of formulation and process variations in the granulation. The ram extruder has been used to characterize the flow of wet masses through a die, which has been divided into stages. They are: (a) compression, where the materials are consolidated under slight pressure, (b) steady-state flow, where the pressure required to maintain flow is constant, and (c) forced flow, where an increase in force is required to maintain flow. The three stages are shown in the force vs. displacement profile in [Figure 4](#).

The change from steady state to forced flow is caused by the movement of fluid under pressure. Extrusion in a ram extruder is continuous, and this phenomenon is



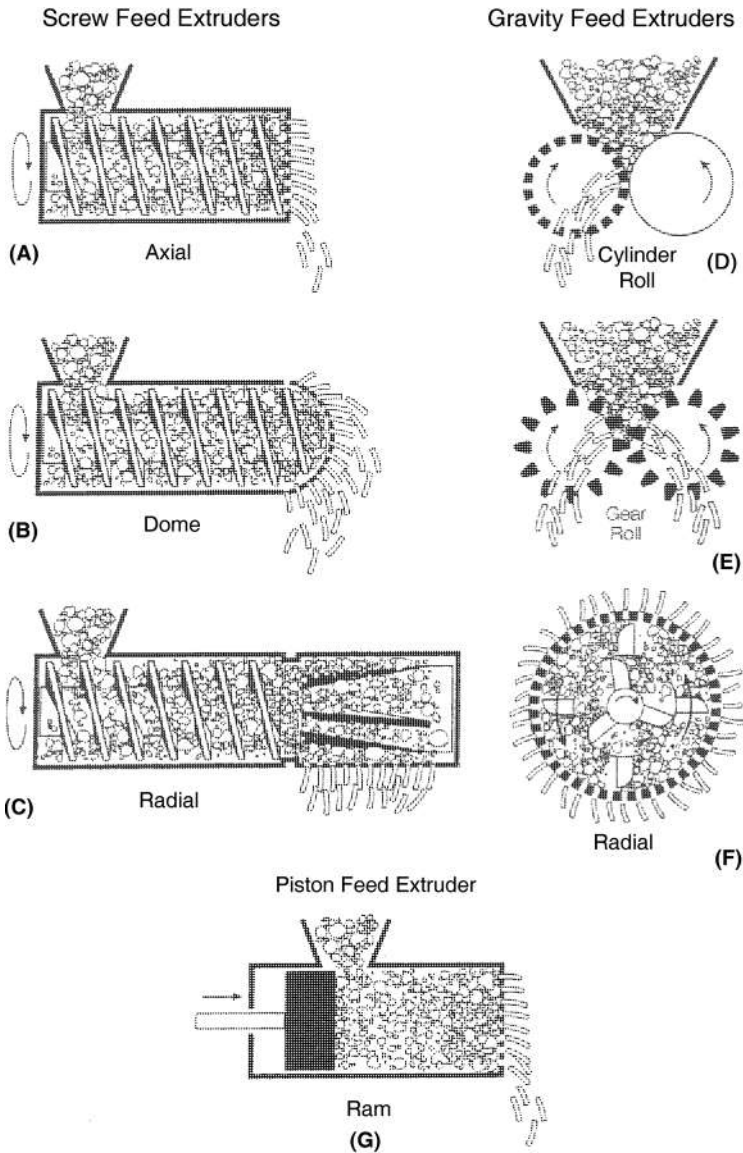
**Figure 4** A force–displacement profile for a microcrystalline cellulose–lactose–water mixture showing the three stages of extrusion on a ram extruder: Compression, steady-state flow, and forced flow (ram speed, 4 mm/sec; die diameter, 1.5 mm;  $L/R$  ratio, 12). (From Ref. 31.)

less likely to be seen in extruders that are discontinuous such as gravity-feed models (32). A diagram of a ram extruder is shown in Figure 5.

Regardless of the mixer used, one must remember that the downstream process steps of extrusion and spheronization are very dependent on the level of water contained in the granulation and the quality of its dispersion. High-energy mixers such as high shear mixers and high shear twin screw mixer/extruders can cause a significant rise in temperature. It may be necessary to use a jacket to guard against heat build-up. High temperatures can result in a greater than tolerable level of evaporation (33) or an increase in the solubility of some of the solids. A reduction in fluid will reduce the plasticity of the granulation, while an increase in solubility will increase the weight ratio of granulating fluid since the solute is then part of that fluid (34). The water solubility of the drug in the granulation plays a key role in determining granulation end point for extrusion/spheronization process. A highly water soluble drug will dissolve in the granulation whereas a highly insoluble drug will have wetting problems during the granulation step. Upon extrusion and during spheronization step a granulation containing a highly insoluble drug at a high dose will have a higher tendency to release moisture due to which the moisture will migrate to the surface of the extrudates, which might cause interpellet sticking. In order to avoid this Mehta et al. in their work demonstrated the use of small quantities of talc to adsorb the surface moisture which helped in the spheronization step without altering the drug release from the resulting pellets (2).

### 4.3. Extrusion

The third step is the extrusion step which forms the wet mass into rod-shaped particles. The wet mass is forced through dies and shaped into small cylindrical particles having a uniform diameter. The extrudate particles break at similar lengths under



**Figure 5** Schematic diagrams of extruder types used in extrusion/spheronization.

their own weight. The extrudate must have enough plasticity to deform but not so much to adhere to other particles when collected or rolled in the spheronizer.

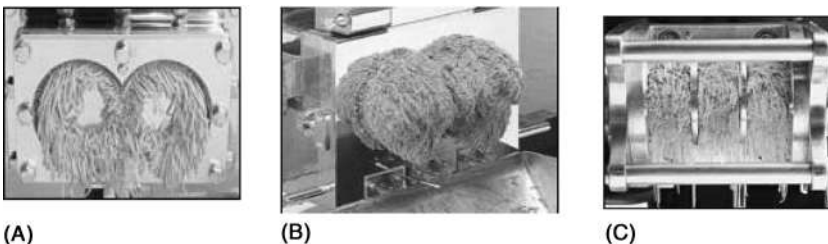
Extruders come in many varieties but can generally be divided into three classes based on their feed mechanism. They include those that rely on a screw, gravity or a piston to feed the wet mass into the extrusion zone (35). Examples of extruders from each class are shown in Figure 5. Screw feed extruders include the (a) axial or end plate, (b) dome, and (c) radial type, while gravity-feed extruders include (d) cylinder, (e) gear, and (f) radial types. The screw and gravity-feed types are used for development and manufacturing with the radial varieties being the most popular for pharmaceutical applications. The piston feed or ram extruder is primarily used in research as an analytical tool.

Screw extruders have either one (single) or two (twin) augers that transport the wet mass from the feed area to the extrusion zone. During the transport process, the screws compress the wet mass removing most of the entrapped air. Studies have been conducted on the ram extruder to understand this compression or consolidation stage. They have shown the apparent density of the wet mass plug prior to extrusion is approximately equal to the theoretical apparent particle density, indicating that nearly all of the voids were eliminated (31). Twin screw extruders generally have a higher throughput than single screw models, while single screw extruders compress and increase the density of the extrudate more. Other features that can affect the density of the extrudate are the spacing of the turnings on the screw and the space between the end of the screw and the beginning of the die (36). Turnings that are wide and regularly spaced minimize the amount of compression during material transport. Screws with closer or progressively closer spacing between the turnings will result in more compression and produce a denser extrudate. Space between the screw and the die results in a void into which material is deposited and compressed. The greater the space, the more compression takes place prior to extrusion. As material builds up, pressure increases and causes the material to be forced, under hydraulic pressure, to flow through the die. When space between the screw and the die is at a minimum, extrusion takes place as material is compressed in the nip, between the extruder blade and the die.

The primary difference between the various types of screw extruders is in the extrusion zone. An axial or dome extruder transports and extrudes the wet mass in the same plane. Axial extruders force the wet mass through a flat, perforated end plate, typically prepared by drilling holes in a plate. The thickness of the plate can be more than four times the hole diameter, resulting in high die length to radius ( $L/R$ ) ratios. An axial extruder is shown in Figure 6(A).

Dome extruders use a dome or half sphere shaped screen as the die. It is prepared by stamping holes in metal stock having a similar thickness as the hole diameter. This results in a die  $L/R$  ratio close to 2, however, variations in screen thickness are possible resulting in a slightly higher or lower ratio. A dome extruder is shown in Figure 6(B).

Unlike axial and dome extruders, radial extruders extrude the wet mass perpendicular to the plane of transport. Material is transported to the extrusion zone where it is wiped against the screen die by an extrusion blade. The mass is forced through the die by pressure generated at the nip. A screw feed radial extruder is shown in Figure 6(C).



**Figure 6** Types of extruders. (A) Axial; (B) dome and (C) radial. (Courtesy of the LCI Corporation.)



As with dome type extruders the die is a stamped screen. Due to the shorter die lengths and the increase number of holes or dies, dome and radial extruders have the advantage of higher throughput as compared to the axial type.

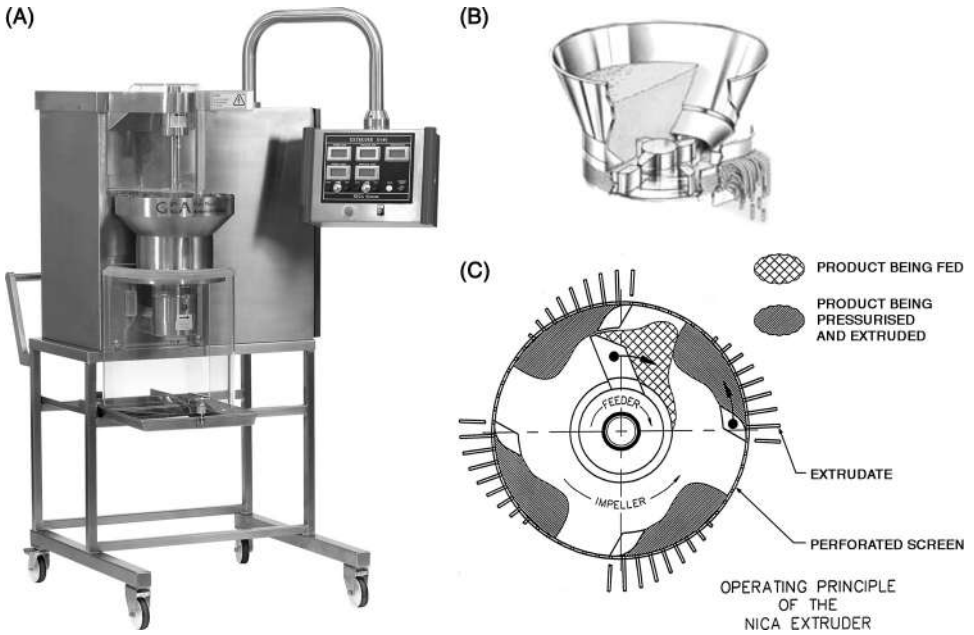
As with almost every step in extrusion/spheronization, heat build-up during extrusion is a significant concern. This is especially true of the screw fed extruders. Axial extruders generate heat due to their long die lengths. Radial extruders can have a significant heat differential over the width of the screen. Materials fed into the extrusion zone will have the lowest temperature. However, as material moves to the front of the zone, the temperature increases due to the longer residence time of material. Of the screw feed extruders, the dome type has the highest rates and is least likely to generate significant heat over an extended period.

Gravity-feed extruders include a cylinder, gear, and radial type. The cylinder and gear both belong to a broader class referred to as roll extruders. Both use two rollers to exert force on the wet mass and form an extrudate. The cylinder extruder has rollers in the form of cylinders, one solid and one hollow with drilled holes to form the dies. The wet mass is fed by gravity into the nip area between the two cylinders and forced through the dies into the hollow of the cylinder. Gear type extruders have rollers in the form of hollow gears. The dies are holes drilled at the base of each tooth. Wet mass is forced through the holes and collected in the hollow of the gears as the teeth and the base areas mesh. The last type of gravity-feed extruder to be discussed is the radial type. One or more arms rotate to stir the wet mass as it is fed by gravity. Rotating blades wipe the wet mass against the screen, creating localized forces sufficient to extrude at the nip. There is no compression prior to extrusion which is the major difference between the gravity and screw feed radial extruders. A gravity-feed extruder is shown in [Figure 7](#).

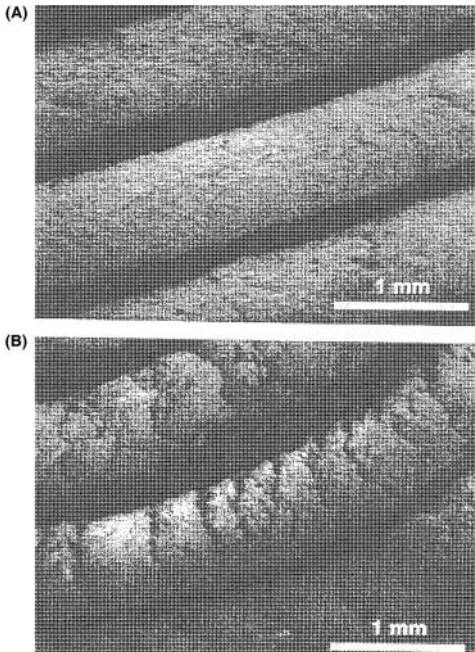
The primary extrusion process variables are the feed rate, die opening, and die length. The water content of the granulation is also very critical, since the properties of the extrudate and resulting spheres are very dependent on the plasticity and cohesiveness of the wet mass. The process variables and water content have been the focus of many studies. Harrison, Newton, and Rowe studied the flow of the wet mass as it is forced through a die (29,31,37,38). They determined that steady-state flow (described earlier and shown in [Fig. 4](#)) was essential to produce a smooth extrudate, which results in uniformly sized spherical particles having good sphericity and surface characteristics. Materials and processes that did not result in steady state, a condition referred to as forced flow, produced extrudate having surface impairments. In moderate cases, the surface is rough, while in more severe cases, a phenomenon commonly referred to as shark-skinning occurs. Examples of smooth extrudate and shark-skinned extrudate are shown in [Figure 8\(A\)](#) and (B), respectively.

Force-displacement profiles of microcrystalline cellulose (MCC) and water at various ratios, MCC, lactose, and water at a 5:5:6 ratio, and lactose and water at a 8:2 ratio, developed by Harrison et al., are shown in [Figure 9](#).

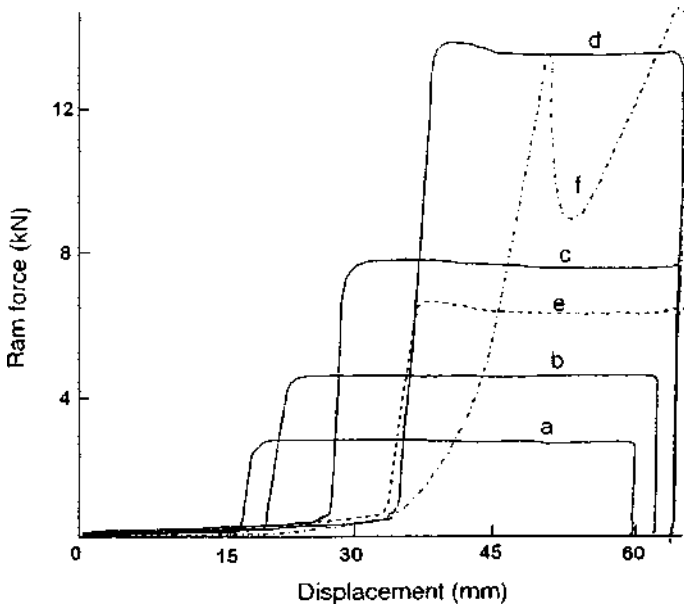
Steady state was possible with the MCC and MCC:lactose samples but not with lactose alone. As can be seen with the MCC samples, the duration of the compression stage was water level dependent with no effect seen on the steady state stage. Additional studies indicated the effect of ram speed (extrusion speed) and die  $L/R$  ratio. An increase in ram speed increased duration of the steady-state stage with no effect on the compression stage. The  $L/R$  ratio had no effect on either compression or steady state. Wet mass composition, therefore, influenced the ability to achieve steady state while the water level and ram speed influenced duration. Higher water levels decreased the force to produce steady-state flow but increased



**Figure 7** (A) Gravity-feed rotary extruder; (B) close-up showing the extrusion zone; (C) operating principle of gravity-feed extruder. (Courtesy of Niro Pharma Systems.)



**Figure 8** Scanning electron micrographs showing an example of (A) smooth extrudate and (B) extrudate having surface impairment, or shark-skinning.



**Figure 9** Force–displacement profiles at various moisture contents of mixtures of microcrystalline cellulose and water: (a–d) microcrystalline cellulose–lactose–water (5:5:6); (e) lactose–water (8:2); (f) at a ram speed of 4 mm/sec, die diameter of 1.0, and a  $L/R$  ratio of 12. Percentage of moisture content of microcrystalline cellulose–water mixture: a, 59.4; b, 51.1; d, 45.0. (From Ref. 29.)

the duration. Faster ram speeds (extrusion rates) increased the duration of steady state and increased the force. As discussed in the following text, other investigators have reported the correlation between extrusion force and sphere quality.

Fechner et al. indicated that for an optimum extrusion process, a mixture of spongelike and gel-like behavior might be desirable which are possible by the use of MCC and powder cellulose (39).

Harrison et al. also indicated that a uniform lubricating layer at the die wall interface must occur to eliminate the slip-stick phenomenon responsible for forced flow. Development of a lubricating layer was dependent on the length of the die (a minimum length required), wall shear stress and upstream pressure loss. They represent the frictional forces at the die wall interface and the estimated pressure loss at zero die length in the barrel of the ram extruder. The method for deriving these values is described in Ref. 27. These parameters allow for a quantitative comparison between formulations and process; however, no specific values can be targeted since they vary with materials.

Pinto et al. also showed that, at slow ram speeds, water moves toward the die wall interface and acts as a lubricant resulting in reduced extrusion forces. At higher speeds water is unable to move rapidly through the mass resulting in higher forces (40). They indicated that the water content and its distribution are critical in determining the particle size and sphericity of the product. Lower water content and higher speed will reduce the size and sphericity of the particles. The extrusion speed and water content should be adjusted to achieve the desired effect. Other researchers have investigated the effect of die length using gravity-feed radial extruder. Hellén et al. indicated the extrudate became smoother and more bound as the  $L/R$  ratio

of the die was increased (41). Vervaet et al. reported that a higher  $L/R$  ratio enables the use of lower water levels to achieve a more bound extrudate (42). This also increased the range (drug loading and water level) over which quality spheres could be produced. They attributed the increased latitude and capability to increased densification and resulting well-bound extrudate. The average pore diameter and bulk density reported for extrudate prepared from various MCC:DCP:water ratios at two  $L/R$  ratios are shown in Table 1.

Baert et al. also indicated a similar increase in latitude when a cylinder extruder having an  $L/R$  ratio of 4 was compared to a twin screw extruder having a  $L/R$  ratio of close to 1.8 (43). Other studies have shown that there is an optimal pressure range over which extrudate capable of yielding acceptable spheres can be produced. Shah et al. demonstrated the correlation between screen pressure yield and density (44). A high yield of spheres within a targeted narrow size distribution was produced as long as the screen pressure was maintained within a given range. The relationship between yield and screen pressure is shown in Figure 10.

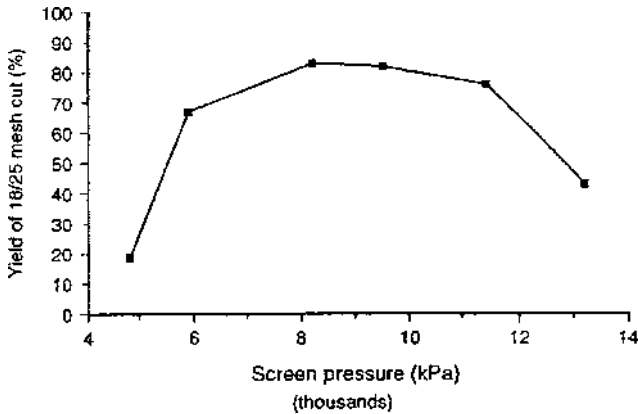
While many of the researchers have indicated a need for a more cohesive extrudate, few have expressed a need to remove all surface impairments. Some researchers have indicated that spheres having acceptable characteristic can be produced from extrudate having shark-skinning. O'Connor and Schwartz have found the presence of shark-skinning to be advantageous in facilitating the breakage of the extrudate during the spheronization step (45).

Experimental design studies conducted to concurrently investigate the effect of extrusion as well as other process and formulation variables have indicated the extrusion variables to be less significant than granulating fluid level or variables of the spheronization step. Hasznos et al. determined that extruder speed had little effect on the size distribution of the final product or moisture change during processing as compared to the spheronization variables (46). Hilemann et al. indicated that, when water/MCC ratios are held constant, a change in screen size results in a significant change in the size distribution (47). However, in a study where water level was included as a variable, Erkoboni et al. have shown that the effect of screen size on size distribution is small compared to the effect of a change in water level. A change in water level can shift the mean size and still result in an acceptable distribution (21). This is in agreement with earlier work by Malinowski and Smith who also showed the mean particle size is typically smaller than the size of the screen itself due to shrinking during the drying step (12). Vervaet et al. have presented an excellent review of extrusion spheronization (48).

**Table 1** Average Pore Diameter and Bulk Density of Extrudate Composed of DCP–Avicel PH-101–Water Mixture, Extrudated Using Screens with Different  $L/R$  Ratios

Composition DCP– Avicel–water (w/w)	$L/R$ ratio of screen	Average pore diameter ( $\mu\text{m}$ )	Bulk density (g/mL)
150:380:470	4	0.982	1.132
150:400:450	4	0.992	1.211
150:380:470	2	1.249	0.949
150:400:4502	2	1.292	0.947

Source: From Ref. 42.



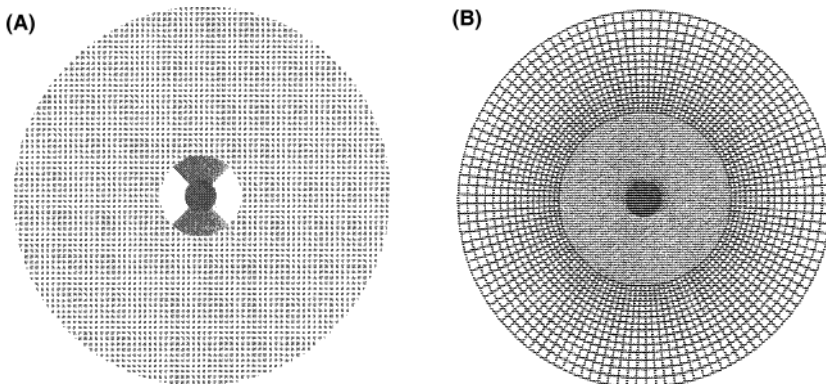
**Figure 10** The effect of extruder screen pressure on the yield of particles within an acceptable distribution. (From Ref. 44.)

#### 4.4. Spheronization

The fourth step in the extrusion/spheronization process is the spheronization step. It is carried out in a relatively simple piece of equipment. The working parts consist of a bowl having fixed sidewalls with a rapidly rotating bottom plate or disk. The rounding of the extrudate into spheres is dependent on frictional forces. The forces are generated by particle-to-particle and particle-to-equipment interactions. For this reason the disk is generally machined to have a grooved surface which increases the forces generated as particles move across its surface. Disks having two geometric patterns are produced, a cross-hatched pattern with the grooves running at right angles to one another and a radial pattern with the grooves running radially from the center. The two varieties are shown graphically in Figure 11.

Some studies have shown the rate of spheronization to be faster with the radial pattern; however, both plates will result in acceptable product (35).

During the spheronization step, the extrudate is transformed from rod-shaped pellets into spherical particles. This transition occurs in various stages. Once charged



**Figure 11** Spheronizer disks having two geometric patterns: (A) a cross-hatched pattern with the grooves running at right angle to one another and (B) a radial pattern with the grooves running radially from the center.

into the spheronizer, the extrudate is drawn to the walls of the extruder due to centrifugal forces. From here what happens is very much dependent on the properties of the extrudate. Under ideal conditions, the extrudate breaks into smaller, more uniform pieces. Within a short period of time, the length of each piece is approximately equal to the diameter, due to attrition and rapid movement of the bottom plate or disk. The differential in particle velocity as they move outward to the walls, begin to climb the walls and fall back onto the rotating bed, along with the angular motion of the disk results in a rope-like formation (5). Figure 12 shows the rope-like formation of the extrudates.

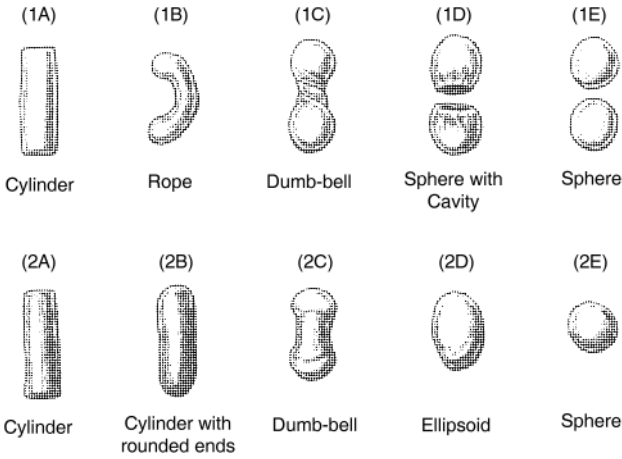
This formation can be a critical indicator of the quality of the granulation or extrudate. As pointed out by Reynolds (5), the disk rotating without movement of the product indicates an over wet condition. The condition is caused either from a granulation that was initially over wet or migration of water or a fluid ingredient to the surface of the extrudate during extrusion or spheronization.

As mentioned, the transformation from cylinder-shaped extrudate to a sphere occurs in various stages. Two models have been proposed to describe the mechanism and are shown graphically in Figure 13.

The model proposed by Rowe in 1985 describes a transition whereby the cylindrical particles (Fig. 13-2A) are first rounded off into cylindrical particles with rounded edges (Fig. 13-2B), then form dumbbell-shaped particles (Fig. 13-2C), ellipsoids (Fig. 13-2D), and finally spheres (Fig. 13-2E) (35). The second model proposed by Baert et al. in 1993 suggests that the initial cylindrical particles (Fig. 13-1A) are deformed into a bent rope-shaped particle (Fig. 13-1B), then form a dumbbell with a twisted middle (Fig. 13-1C). The twisting action eventually causes the dumbbell to break into two spherical particles with a flat side having a hollow cavity (Fig. 13-1D). Continued action in the spheronizer causes the particles to round off into spheres (Fig. 13-1E). When the sphere is fractured a hollow particle is revealed (49). The exact mechanism is likely to be composition dependent. If the extrudate is overwet, particle growth will occur resulting in a broad size distribution. Under wet extrudate will not have enough plasticity to further round off in the spheronizer; the result is the formation of dumbbells. The scanning electron micrographs in Figure 14 show an example of good spheres produced from a sufficiently plastic mass and dumbbells that would not deform further.

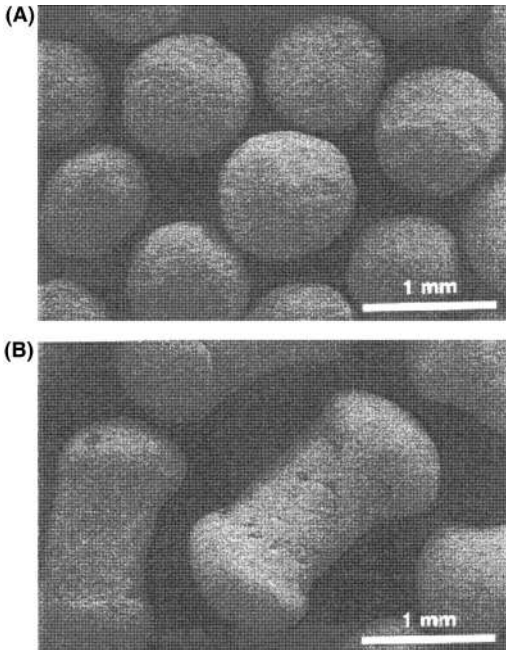


**Figure 12** A characteristic rope-like formation in a spheronizer bowl during operation.



**Figure 13** A graphic representation of the two models proposed to describe the mechanism of spheronization. The model proposed by Baert et al. (38) describes a transition from initial cylindrical particles (1A) into a bent rope (1B), dumbbell (1C), two spherical particles with a hollow cavity (1D), and spheres (1E). The model proposed by Rowe (25) describes a transition from cylindrical particles (2A) into cylindrical particles with rounded edges (2B), dumbbells (2C), ellipsoids (2D), and spheres (2E). (From Refs. 35,49.)

Of the two process steps unique to extrusion/spheronization, the first, extrusion, is a continuous process while the second, spheronization, is a batch process. To make the process viable for commercial operations, two systems have been developed to enable the extruder to continuously feed material to the spheronizer(s). The



**Figure 14** An example of (A) good spheres produced from a sufficiently plastic mass and (B) dumbbells that would not deform further produced from underwet extrudate.

first system is a semicontinuous shuttle system and the second is a cascade system. The shuttle system is typically used when uniform particles are required, such as for controlled release coating applications. The cascade system, however, can be used for applications where less size and shape uniformity is required, such as granulations intended for compression.

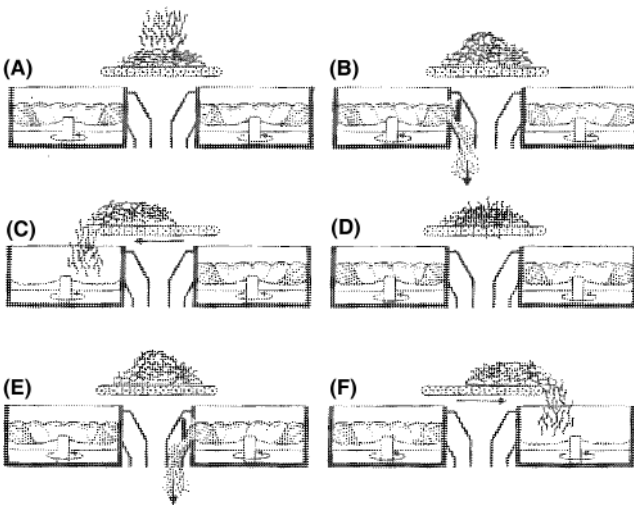
The shuttle system uses two spheronizers in parallel. It is designed to fill one spheronizer while the second is in the middle of its cycle, continue to collect extrudate in a shuttle receptacle while they are both full and operational, and fill the second after it empties and the first unit is in the middle of its cycle. The shuttle system operation is shown graphically in Figure 15.

A picture of a spheronizing system having twin spheronizers is also shown in Figure 16.

The cascade operation uses one or more spheronizers that are modified to have the disks some distance below the discharge chute (36). This results in a spheronization zone having a fixed volume. The product is continually fed from either the extruder or a previous spheronizer. As the charge volume grows from incoming material some product is discharged. The residence time is dictated by the feed rate. The reduced size and shape distributions are due to the percentage of material that does not reside in the spheronization zone for the intended period of time. The number of spheronizers placed in sequence depends on the desired outcome. However, if only a slight rounding with minimal densification is required, one spheronizer with a short residence time will be sufficient.

A commercial manufacturing of pellets using the extrusion/spheronization process can be accomplished by discharging the formed pellets from the spheronizer in a continuous fluid bed unit. This provides the semiautomatic commercial setup. Figure 17 illustrates a typical setup in such an equipment configuration.

Variables in the spheronization step include spheronizer size, charge, disk speed, and residence time. A number of studies have shown each of the variables



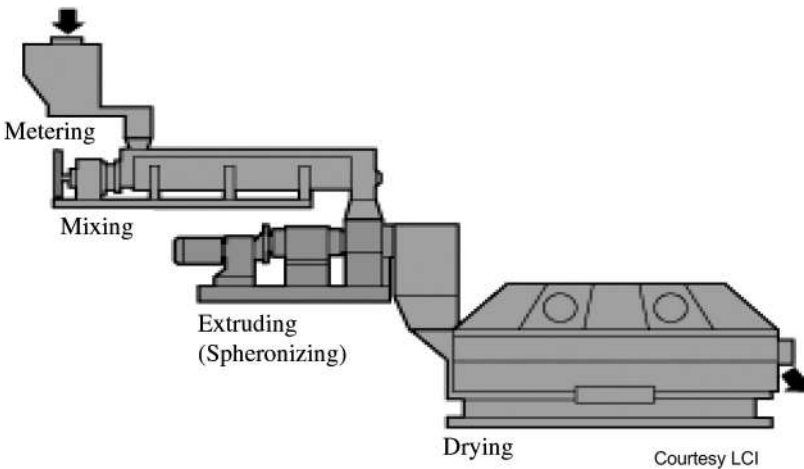
**Figure 15** A graphic representation of twin spheronizer shuttle system using two spheronizers in parallel and shuttle receptacle. (A) When both units are full the shuttle receptacle collects the extrudate. (B) After one empties, (C) the shuttle box fills it. (D–F) The cycle repeats itself for the second unit. (From Ref. 36.)





**Figure 16** Twin spheronizer with extruder. (Courtesy of Niro Pharma Systems.)

has the potential to play a significant role in influencing the physical characteristics of the resulting product. Hasznos et al. (46) showed that a higher disk speed and longer residence time increased the coarse fraction and mean diameter and decreased the fine fraction. The faster speed and longer time also increased the moisture loss during the process. Since the moisture loss can reduce the plasticity of the particle, it can have the same effect as an underwet granulation. The particles may not round off into spheres and stay as deformed cylinders or dumbbells. Higher spheronizer



**Figure 17** Typical semicontinuous pellet production setup. (Courtesy of LCI Corporation.)

charges reduced the moisture loss. They also suggested that an interaction between spheronizer speed and residence time indicated the total number of revolutions of the disk was critical. A change in one of the variables could be offset by an opposite change of the other, as long as the total number of revolutions remained constant (46). Hellén et al. showed a similar moisture loss during spheronization. In addition, they indicated that the major factors influencing the shape of the spheres were the disk speed and residence time. High speed and long time produced more spherical particles (26). Wan et al. indicated that a minimum disk speed and residence time was required to round the cylinder-shaped extrudate. Furthermore, an increase in speed or time, up to a limit, increased the median diameter of the spheres while higher speeds and longer times caused a reduction in size. Short residence times at high disk speeds resulted in small but round particles (50).

A number of investigators have reported the effect of disk speed and residence time on density. Woodruff and Neussle reported the variables to have no effect on the density of the spheres as compared to the density of the granulation and extrudate (16). These results are in conflict with most of the other studies; however, they are likely due to the use of mineral oil in the formulation. The oil can reduce the frictional forces at the die wall during extrusion and between particles and equipment surfaces during spheronization. A number of investigators including Malinowski and Smith reported that an increase in either disk speed or residence time resulted in an increase in density (20,21,26,47). Mehta et al. studied the effect of spheronization time on the pellet hardness and drug release (2). It was concluded that pellet hardness changed with spheronization time until about 10 min after which the hardness decreased until the 20 min point. No significant difference in pellet hardness from 20 to 40 min thereafter was observed. Mehta et al. explained this by the densification process occurring during the spheronization step. As spheronization time progresses from time zero to a certain time point "*t*" the extrudates are cut into uniform particles and shaped into spheres by the centrifugal and frictional forces present in the spheronizer during the operation. These forces act on each and every particle, making them denser and more spherical with time. However, after a critical period, no further densification occurs with an increase in spheronization time. In another study, Mehta et al. showed the effect of spheronization time on the porosity parameters of the pellets (51). It was summarized that a processing period of 2–10 min increased the number of pores and the total pore surface area and decreased the pore diameter. Beyond this time, for up to 20 min of spheronization time, the porosity was unchanged.

O'Connor et al. indicated that the friability of placebo spheres decreased with increasing residence time while the mean particle diameter decreased (24). Erkoboni et al. showed an increase in extruder screen size resulted in reduced friability (21).

#### 4.5. Drying

Drying is the final step in the process. This can be accomplished in any dryer that can be used for conventional type granulations, including tray dryers, column type fluid beds, and deck type vibratory fluid beds. Each of the drying techniques has advantages; however, the major differences are based on the rate of water removal. Tray drying is the slowest of the processes. Fluidized bed dryers result in a much more rapid drying rate because of the higher air volumes and the potential use of higher inlet temperatures. Column fluid beds are batch dryers, while the deck type dryers offer the advantage of a continuous process. Both have been used successfully in

drying product produced by extrusion spheronization. The drying process must be chosen based on the desired particle properties. For example, pellets to be dried in fluid bed equipment will have to withstand fluidization process, resist attrition, and maintain its integrity.

Tray drying is a slow process in a static bed. Because of this, it can offer the greatest opportunity for a drug to migrate toward the surface and recrystallize (52). The more rapid rate in a fluid bed will likely minimize the effects of migration. This phenomenon can have an effect on a number of particle properties. The increased active concentration at the surface of the particle can increase the rate of dissolution. This recrystallization, however, can cause a problem for applications requiring film coating since the smooth surfaces developed by the spheronization process would be damaged. Additionally, the crushing strength of tray dried particles will likely be greater than their fluid bed counterparts. The slow recrystallization in the static bed allows for crystal bridges to develop as the fluid is removed and the solute recrystallizes.

## 5. FORMULATION VARIABLES

The composition of the wet mass is critical in determining the properties of the particles produced. This is clearly understood if we look at what material behaviors are required during each of the process steps. During the granulation step, a plastic mass is produced—a simple enough task if ended there. The materials must form a plastic mass, deform when extruded and break off to form uniformly sized cylindrical particles. A minimal amount of granulating fluid should migrate to the surface during extrusion and the particles should stay discrete during collection. During spheronization the particles must round off to form uniformly sized spheres. They must not dry out due to temperature or air volume or grow in size due to agglomeration. The fact is that a lot is expected from materials used in this process. This is especially true of formulations containing high percentages of active where low levels of excipients are used to impart the desired properties to the mass.

The importance of using sphere-forming excipients was noted early on. Conine and Hadley cited the necessity of using microcrystalline cellulose (4). Reynolds went on to indicate the need for either adhesive or capillary type binders (5). He cited cellulose gums, natural gums, and synthetic polymers as adhesives and microcrystalline cellulose, talc, and kaolin as capillary type binders. Since then much work has been conducted in an attempt to understand the significance of material properties. Some of the studies are discussed in the following text.

O'Connor et al. studied the behavior of some common excipients in extrusion/spheronization. The materials were studied as single components using water as the granulating fluid in an attempt to understand their application in the process. Of the materials tested, only MCC or MCC with Na-CMC (Na-carboxymethyl cellulose) was capable of being processed. Others including dicalcium phosphate, lactose, starch, and modified starch did not process adequately (24).

In an additional study, they investigated the effect of varying drug, excipient, and excipient:drug ratios. At low drug levels they found the spheronizing excipient played the most significant role in determining sphere properties. They found that, for low dose applications, MCC was the best excipient to use since it formed the most spherical particles. At moderate drug loading (50%), MCC as well as the two products consisting of MCC coprocessed with Na-CMC (Avicel<sup>®</sup> RC-581 and

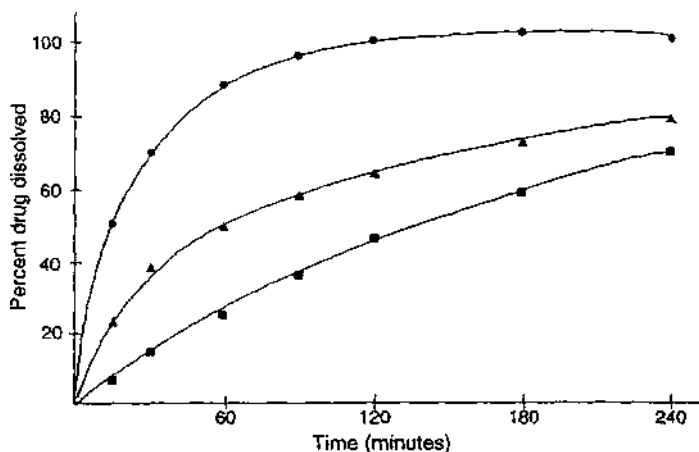
Avicel CL-611) resulted in acceptable spheres. At higher loading levels, however, the MCC did not yield acceptable spheres and the coprocessed materials did. The spheres produced using Avicel CL-611 were the most spherical. In addition, they found dissolution to be dependent on the type of excipient used, the solubility, and concentration of the active. Spheres containing MCC remained intact and behaved as inert matrix systems, while those containing the coprocessed products formed a gel plug in the dissolution basket and were described as water-swallowable hydrogel matrix systems. The release profiles for spheres containing each of the excipients and theophylline in a 50:50 ratio are shown in Figure 18.

Release profiles for spheres containing different drug loads are shown in Figure 19.

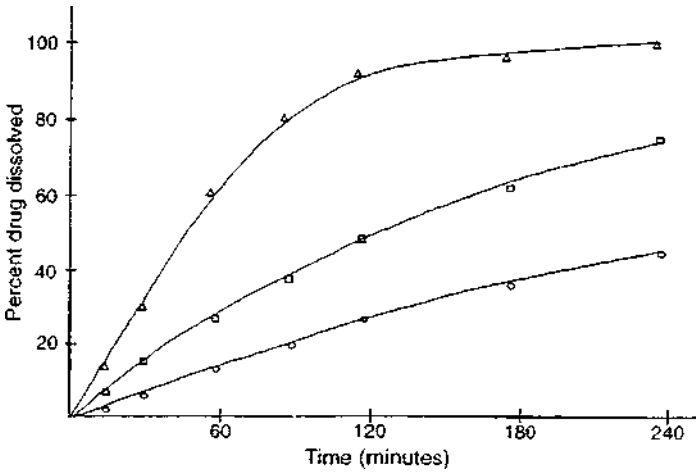
An increase in drug load resulted in an increased release rate. Release profiles for spheres containing actives having different solubilities, including chlorpheniramine maleate, quinidine sulfate, theophylline, and hydrochlorothiazide are shown in Figure 20. An increase in drug solubility resulted in an increased release rate (53).

Mehta and Kislalioglu demonstrated the use of polymethacrylate type polymers such as Eudragit L 100–55 and Eudragit S 100 via extrusion/spheronization in the development of controlled release pellets (13,54). They theorized that for the development of zero-order controlled release pellets of a poorly soluble drug, MCC would not be a good choice to form a pellet system via extrusion/spheronization. This would be due to the fact that MCC being insoluble would form a nondisintegrating matrix from which it would be difficult for an insoluble drug to be released. In their work they showed that Eudragit L100–55 and Eudragit S 100 can be used as pellet forming and release rate governing polymers for developing a controlled release drug delivery system with out the use of MCC in the matrix.

Zhou and Vervaet produced matrix pellets by combining microcrystalline waxes, pregelatinized starches, and hydrolyzed starches with model drugs such as Ibuprofen, chloroquin phosphate, and others (55). They concluded that the combination of microcrystalline waxes and pregelatinized starches or maltodextrins is a flexible system for the production of matrix pellets, even with a high drug concentration. Additionally, they concluded that the drug release with such a system could be



**Figure 18** Dissolution profiles of spheres containing 50% theophylline in different Avicel MCC types • Avicel PH-101; ▲, Avicel RC-581; ■, Avicel CL-611. (From Ref. 53.)

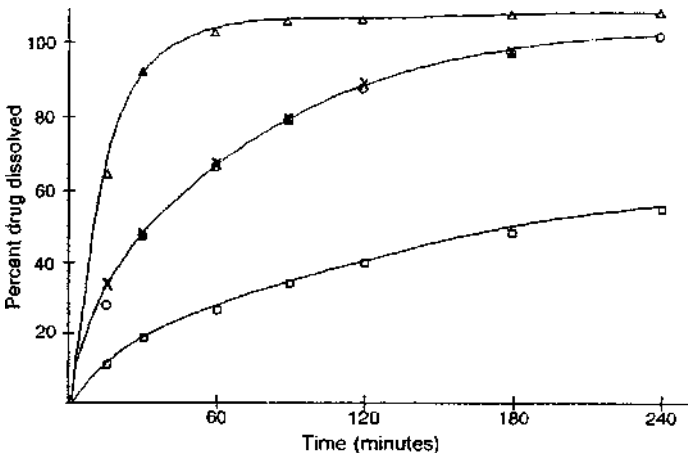


**Figure 19** Dissolution profiles of spheres containing different concentrations of drug in Avicel CL-611: ○, 10%; □, 59%; △, 80%. (From Ref. 53.)

modeled by varying the type and the concentration of the wax and the starch. Tapia et al. described factors influencing the mechanism of release from sustained release matrix pellets, produced by the extrusion/spheronization process (56).

Kleinebudde and Jumaa concluded that during the extrusion process, water content in the extrudate and pellet porosity were increased as the degree of polymerization of MCC and powder cellulose in the matrix was increased (57).

Millili and Schwartz demonstrated the effect of granulating with water and ethanol at various ratios. The physical properties of the spheres changed significantly as the ratio of the two fluids was varied. Spheres could not be formed with absolute ethanol but were possible with 5:95 water:ethanol. An increase in the water fraction resulted in a decrease in porosity, friability, dissolution, and compressibility and an increase in density. The porosity of spheres granulated with 95% ethanol was 54%



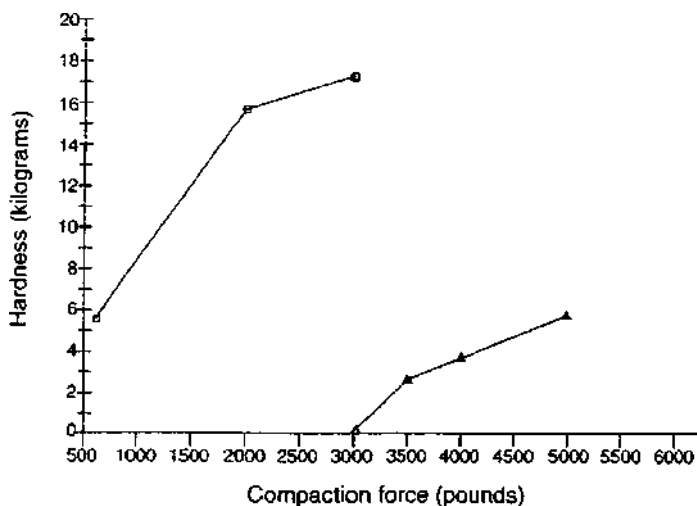
**Figure 20** Dissolution profiles of spheres containing 10% drug in Avicel PH 101: ●, chlorpheniramine maleate; ○, quinidine sulfate; ×, theophylline; □ hydrochlorothiazide. (From Ref. 53.)

while the water granulated product had a porosity of 14%. When greater than 30% water was used, spheres remained intact throughout the dissolution test. As previously discussed, water granulated spheres were very difficult to compress while spheres granulated with 95% ethanol were significantly more compressible than those prepared using water (18). In contrast, Mehta et al. showed that an increase in granulation water level increased the total number of pores in the pellet matrix without changing the pore diameters (51). Additionally they concluded that this direct increase in porosity increased the dissolution contact angle due to which dissolution of the poorly soluble drug was increased. Jerwanska et al. concluded that the rate of drug release increased with increased levels of granulation liquid because of a greater degree of porosity obtained after drying (58). They also correlated these results with differences in hardness of the pellets. This was similar to the findings by Mehta et al. Jerwanska et al. proposed that for a continuous extrusion process, adequate water is required to bridge the particles together until liquid saturation in the granulation is achieved. This strategy is necessary to deform the granulation to form extrudates and consequently shape them into spheres by spheronization. If the granulation water level is below the liquid saturation point, then the spheres obtained will be hard and less porous, thereby leading to decreased drug release rates. Above the liquid saturation point, the hardness and porosity of the pellets are not significantly decreased.

A tablet hardness vs. compression forces profile is shown in Figure 21.

In a later study, Millili et al. proposed a bonding mechanism, referred to as autohesion, to explain the differences in the properties of spheres granulated with water and ethanol. Autohesion is a term used to describe the strong bonds formed by the interdiffusion of free polymer chain ends across particle-particle interfaces (59).

Using a ram extruder, Harrison et al. demonstrated that steady state flow could not be achieved with lactose. Additionally, they demonstrated the reduced sensitivity of MCC to small changes in moisture as determined by the force required to induce plug flow in a cylinder. Comparing MCC to a MCC/lactose blend and 100% lactose,



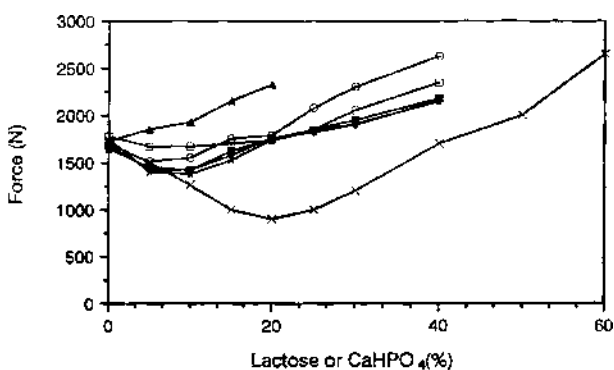
**Figure 21** The effect of varying compression force on the hardness of compacted 16/30-mesh spheres of 10% theophylline-Avicel PH101:  $\Delta$ , spheres prepared by water;  $\square$ , spheres prepared by 95% ethanol granulation. (From Ref. 18.)

they found that, with lactose, small changes in moisture caused large changes in force while with MCC, larger changes in moisture were required to have similar effects on the force (29).

Baert et al. used mixtures of microcrystalline cellulose and coexcipients at various ratios to demonstrate the effect of solubility and the total fluid on extrusion forces. They showed that if the coexcipient was insoluble, such as dicalcium phosphate, the force required to extrude increased with increasing levels of coexcipient. When a soluble excipient such as lactose was used, the force required to extrude decreased with the addition of the initial amounts of lactose. After a certain level, however, the reduction in force stopped and began to increase. This was due to the initial solubilization of lactose and the resulting increase in the total fluid level. Once the fluid was saturated the remaining lactose was not soluble and the force began to increase. The increase began at about 10% lactose level for  $\alpha$ -lactose and 20% for  $\beta$ -lactose. This was due to the difference in solubility between the two materials (33). The effects of dicalcium phosphate and various lactose grades on extrusion force are shown in Figure 22.

Funck et al. showed that low levels of common binders could be used to produce high drug loaded spheres with microcrystalline cellulose. Materials such as carboxymethylcellulose (Na-CMC), hydroxypropylcellulose (HPC), hydroxypropylmethylcellulose (HPMC), povidone (PVP), and pregelatinized starch were used. All materials were capable of producing spheres of acceptable quality. Dissolution testing showed spheres containing HPC and HPMC remained intact during testing while spheres containing starch, PVP, and Na-CMC disintegrated (60).

Lender and Kleinebudde reported that spheres produced with powdered cellulose had higher porosity and faster dissolution than those made using microcrystalline cellulose. Spheres could not be produced using only powdered cellulose and drug; a binder was required. The higher porosity of the spheres prepared from powdered cellulose may be beneficial for applications requiring compression (61).



**Figure 22** Influence of the amount of lactose or dicalcium phosphate dehydrate (% total weight) on the extrusion forces (N) for mixtures of lactose or dicalcium phosphate dehydrate-Avicel PH 101-water after granulation with a planetary mixer. Each end point is the mean of six values. The SD is lower than 3% for each point. Six different types of lactose were used: □,  $\alpha$ -lactose monohydrate 80 mesh; ○,  $\alpha$ -lactose monohydrate 200 mesh; ●,  $\alpha$ -lactose monohydrate 325 mesh; ■, spray dried lactose DCL 11; ×, anhydrous  $\beta$ -lactose DCL 21; \*, anhydrous  $\alpha$ -lactose DCL 30. One type of dicalcium phosphate dehydrate was used, ▲. (From Ref. 33.)

Feilden et al. showed that increasing the particle size of lactose resulted in forced flow and high extrusion forces, which resulted in poor quality extrudate and spheres having a wide size distribution. This was attributed to the increased pore diameter of the mixture containing the coarse lactose which allowed greater movement of water (62).

Chien and Nuessle (63) showed the use of a surfactant, such as sodium lauryl sulfate, reduced the migration of drug to the surface of the sphere during drying by reducing the surface tension of the granulating fluid. The reduction in surface tension also made it difficult to produce a cohesive extrudate in some cases.

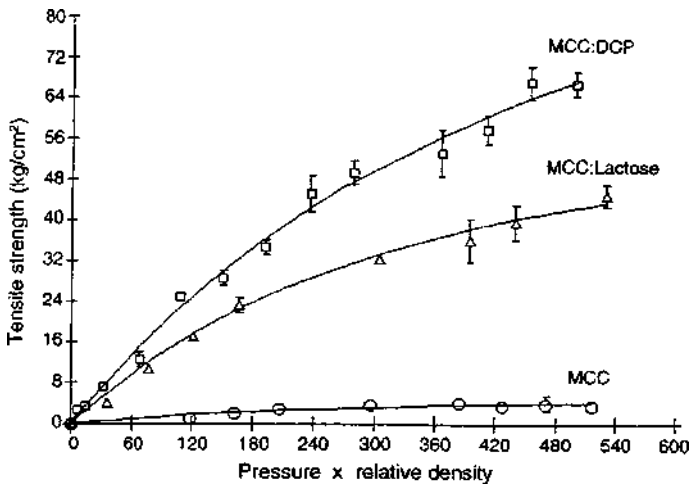
Some miscellaneous observations include the following. Reynolds reported that excess extrudate friability can be overcome by incorporating more MCC, binder, or water in the granulation (5). Erkoboni et al. indicated that sphere hardness was most affected by the level of MCC in the formulation and the level of granulating fluid used (21). Hileman et al. showed that MCC had a narrower water range over which quality spheres could be made than MCC coprocessed Na-CMC (47). Hellén et al. showed that the surface characteristics were influenced by the water level with higher water levels giving smoother surfaces (26). Mehta et al. showed that when concentrations of pellet forming and release rate governing polymers in the matrix were changed, it altered the dissolution kinetics of a poorly soluble drug (2).

## 6. COMPRESSION OF PELLETS

Typically, pellets are produced for administering in a capsule dosage form after manufacturing with desired modified release properties. These pellets can be compressed into tablets as well. The tablets are normally intended to disintegrate into discrete pellets in the gastrointestinal tract and the drug should be subsequently released in a controlled manner from the individual pellets. One challenge in the production of such tablets is maintaining the desired drug release after compaction, as the application of a compaction pressure can lead to structural changes in the film coating and consequently, altered drug release. Numerous investigations have been made into the compaction of pellets, coated or uncoated. It is imperative that the coated pellets do not lose their release properties during the compression stage. Pellets have been shown to react differently to compaction and consolidation than powders of the same material. Wang et al. reported compression of various lactose/microcrystalline cellulose compositions in powder or pellet form (64). Schwartz et al. (17) demonstrated the compaction characteristics of MCC processed into spheres are significantly different than the original powder. The powder material forms hard compacts at low compression forces, while the spheres are not compressible and form soft compacts, even at high forces. They indicated that spheres prepared from MCC showed a high degree of viscoelasticity over the entire compression range. Inclusion of coexcipients such as lactose and dicalcium phosphate increase the compactability by decreasing the viscoelastic resistance or pressure range over which the spheres behave elastically. A reduction in viscoelastic resistance was seen with spheres containing both lactose and dicalcium phosphate; however, dicalcium phosphate had a greater effect. Compaction profiles of spheres containing 10% theophylline with MCC, MCC/DCP, or MCC/lactose in a 22.5/67.5 ratio are shown in [Figure 23](#).

A similar phenomenon was reported by Maganti and Celik when pellets produced by rotor granulation were compressed (65). They compared the compaction behavior of pellet formulations, mainly consisting of MCC, to that of the powders





**Figure 23** The effect of excipients on the compaction profile of spheres. Compaction profiles of spheres containing 10% theophylline with either MCC, MCC–DCP, or MCC–lactose in a 22.5:67.5 ratio using the Leunberger model. (From Ref. 17.)

from which they were formed and also found significant differences. The powders examined were found to compact by plastic deformation and produced strong compacts, while the pellets exhibited elastic deformation and brittle fragmentation, resulting in compacts of lower tensile strength. This can be explained by the fact that the pellets, which are large and spherical in shape as compared to the small, irregular powder particles they are composed of, have a low surface-to-volume ratio, which might result in a decreased area of contact between the particles as they consolidate. Nicklasson (66) investigated the compression behavior of pellets consisting of MCC, with or without other excipients such as polyethylene glycol and DCP. Deformation of the aggregates was found to depend on three deformation characteristics, namely, the capacity for, the mode of and the resistance to deformation. High surface deformation refers to the great ability of the pellets to conform to the surface of the surrounding pellets. In pellets containing the soft component, the primary particles can reposition within the agglomerate and the ability to fill the intragranular pore space is increased. For pellets containing hard materials, the compaction stress may give local failure at pellet surfaces. Thus, the material properties of the primary particles constituting the pellets are important for the compression behavior of pellets. In number of studies (67,68) various soft materials have been incorporated in pellets to modify their deformability and compatibility. Nicklasson and Alderborn (69) studied the modulation of the tableting behavior of pellets through the incorporation of polyethylene glycol and found that these soft pellets had an increased propensity to deform and altered mode of deformation to the relatively hard MCC pellets. Iloañusi et al. (67) found MCC-based bead formulations incorporating wax to be more compressible than those made without wax. Salako et al. (68) found that pellets containing theophylline and MCC were hard and less brittle than the ones containing glyceryl monostearate which were soft pellets. The soft pellets were found to fracture under low compression pressures and were able to form a coherent network of deformable material in the tablets at higher pressures. The hard pellets were unable

to form such a network at high pressures and found to reduce more in volume without bond formation than soft pellets.

The size of the pellets can also have a bearing on their compression behavior. Small pellets have been shown to be less affected than larger ones by the compaction process (70,71). Smaller beads were significantly stronger, relative to their size, than larger ones. Researchers also found that larger pellets were much more readily deformed (71). The application of coating to the pellet core can influence their compression characteristics. Magnati et al. (72) added a water-based ethyl cellulose coating (Surelease) to the MCC-based pellets previously used (65) and thereby altered their deformation characteristics, introducing plastoelastic properties whereas previously they had been brittle and elastic. The overall ability of the pellets to deform, both plastically and elastically, increased with an increasing coating level. Miller et al. (73) investigated the mechanical properties of tablets compressed from pellets coated with Surelease to that of uncoated pellets and found them to be comparable with the exception of the diametrical strain, which increased on coating. This was attributed to the flexibility of the plasticized ethyl cellulose, allowing greater deformation of the compact to occur before failure.

It has been found that coated pellets can be compressed into tablets while retaining controlled release of the drug, provided that the effect of excipients and compression force is considered and determined. The protective effect of an excipient is dependent on the particle size and the compaction characteristics of the material. In general, materials that deform plastically, such as MCC and PEG, give the best protective effect (74–77). Yuasa et al. studied the protective effect of 14 different excipients and were able to correlate the plastic energy percentage to the release rate, that is, materials that deform plastically were shown to protect the coating best (78). However, Stubberud et al. found that lactose, a fragmented material, gives better protection than MCC (79). The compressed induced changes in the structure of a film coating may depend on formulation factors, such as the type and the thickness of the coating, the properties and the structure of the substrate pellets, and the incorporation of excipient particles.

The optimum amount of excipients incorporated in the tablet formulation was concluded to be 30% (80). Palmieri et al. (81) showed that tablets consisting of maximum 40% coated granules had acceptable release profiles, using MCC as the tablet excipient. Wagner et al. (82) concluded that a tablet content of 70% (w/w) of pellets, approximately 1 mm diameter, is a critical level resulting in pronounced damage to the coating. On reducing the pellet proportion to 60% (w/w), tablets fulfilling the compendial dissolution requirements for enteric-coated products can be prepared. Tunón (83) investigated factors that influence the preparation of modified release pellets, its compression behavior, influence of inter- and intragranular factors and release of drug release of pellets. The most frequently encountered explanation for the loss of modified release upon compaction, in terms of an increased drug release rate, is the occurrence of cracks in the coating. However, knowledge of why and how cracks are formed in the coating and techniques to avoid them is highly valuable in the development of multiple unit tablets containing pellets.

## 7. CONCLUSIONS

Extrusion/spheronization is a versatile process capable of producing granules or spheres having unique physical properties. Since it may be more labor and time

intensive than the more common granulation techniques, it should be considered as a granulating technique when the desired properties cannot be produced using more conventional techniques. Potential applications are many including both immediate and controlled release. Regardless of the application, care must be taken to understand the desired properties and the formulation and process variables capable of achieving them. The use of statistical experimental design for formulation and process development is strongly recommended due to the high degree of interactions between the variables. Lastly, new technologies such as hot melt extrusion and spheronization (HME) are gaining considerable interest in the pharmaceutical drug delivery arena for solving specific problems such as enhancing taste masking, improving solubility and drug bioavailability and in general for controlled release drug delivery. Compression of pellets into modified release multiple unit dosage form is now possible once the proper understanding of the formulation of the core pellets, type of coating, and protective excipients to maintain the coating integrity of the pellets is understood.

## REFERENCES

1. Erkoboni D. Extrusion-spheronization for granulation. Parikh DM, ed. *Handbook of Pharmaceutical Granulation Technology*. New York: Marcel Dekker, 1997.
2. Mehta KA, Kislalioglu MS, Phuapradit W, Malick AW, Shah NH. Effect of formulation and process variables on matrix erosion and drug release from a multiunit erosion matrix of a poorly soluble drug. *Pharm Technol* 2002; February:26–34.
3. Nakahara, US Patent 3,277,520, October 1966.
4. Conine JW, Hadley HR. Preparation of small solid pharmaceutical spheres. *Drug Cosmet Ind* 1970; 106:38–41.
5. Reynolds AD. A new technique for the production of spherical particles. *Manuf Chem Aerosol News* 1970; 41:40–43.
6. Mehta KA, Kislalioglu MS, Phuapradit W, Malick AW, Ke J, Shah NH. In vivo release performance of nifedipine in dogs from a novel Eudragit based multi-unit erosion matrix. *Drug Deliv Technol* 2002; 2(2):38–42.
7. Young CR, Koleng JJ, McGinity JW. Production of spherical pellets by a hot-melt extrusion and spheronization process. *Int J Pharm* 2002; 242:87–92.
8. Breitenbach J, Mägerlein M. Melt extruded molecular dispersions. Ghebre-Sellassie I, ed. *Pharmaceutical Extrusion Technology*. New York: Marcel Dekker, 2003.
9. Oshlack B, et al. US Patent 6,706,281, issued March 16, 2004.
10. McGinity J, Repka M. Hot melt extruded films. *Drug Deliv Technol* 2004; 4(7):40–47.
11. Sood A, Ashokraj Y, Panchagnula R. Use of extrusion spheronization to develop controlled release dosage forms for diltiazem hydrochloride. *Pharm Tech* 2004; April:62–85.
12. Jalal IM, Malinowski HJ, Smith WE. Tablet granulations composed of spherical-shaped particles. *J Pharm Sci* 1972; 61:1466–1468.
13. Mehta KA, Kislalioglu MS, Phuapradit W, Malick AW, Shah NH. Release performance of a poorly soluble drug from a novel Eudragit based multi-unit erosion matrix. *Int J Pharm* 2001; 213:7–12.
14. Clarke, GM, Newton JM, Short MB. Comparative gastrointestinal transit of pellet systems of varying density. *Int J Pharm* 1995; 114:1–11.
15. Devereus JE, Newton JM, Short MB. The influence of density on the gastrointestinal transit of pellets. *J Pharm Pharmacol* 1990; 42:500–501.
16. Woodruff CW, Nuessle NO. Effect of processing variables on particles obtained by extrusion-spheronization. *J Pharm Sci* 1972; 61:787–790.

17. Schwartz JP, Nguyen NH, Schnaare RL. Compaction studies on beads: compression and consolidation parameters. *Drug Dev Ind Pharm* 1994; 20:3105–3129.
18. Millili GP, Schwartz JB. The strength of microcrystalline cellulose pellets: the effect of granulating with water/ethanol mixtures. *Drug Dev Ind Pharm* 1990; 16:1411–1426.
19. Malinowski HJ, Smith WE. Effect of spheronization process variables on selected tablet properties. *J Pharm Sci* 1974; 63:285–288.
20. Malinowski HJ, Smith WE. Use of factorial design to evaluate granulations prepared by spheronization. *J Pharm Sci* 1975; 64:1688–1692.
21. Erkoboni DF, Fiore SA, Wheatley TA, Davan T. The effect of various process and formulation variables on the quality of spheres produced by extrusion/spheronization. Poster presentation, AAPS National Meeting, 1991.
22. Chariot M, Francès J, Lewis GA, Mathieu D, Phan Tan Luu R, Stevens HNE. A factorial approach to process variables of extrusion-spheronization of wet powder masses. *Drug Dev Ind Pharm* 1987; 13:1639–1649.
23. Hileman GA, Goskonda SR, Spalitto AJ, Upadrashta SM. Response surface optimization of high dose pellets by extrusion and spheronization. *Int J Pharm* 1993; 100:71–79.
24. O'Connor RE, Holinez J, Schwartz JB. Spheronization I: processing and evaluation of spheres prepared from commercially available excipients. *Am J Pharm* 1984; 156:80–87.
25. Ojile JE, Macfarlane CB, Selkirk AB. Drug distribution during massing and its effect on dose uniformity in granules. *Int J Pharm* 1982; 10:99–107.
26. Hellén L, Yliruusi J, Merkkü P, Kristoffersson E. Process variables of instant granulator and spheronizer: I. Physical properties of granules, extrudate and pellets. *Int J Pharm* 1993; 96:197–204.
27. Kleinebudde P, Lindner H. Experiments with a twin screw extruder using a single-step granulation/extrusion process. *Int J Pharm* 1993; 94:49–58.
28. Lindberg NO, Tufvesson C, Holm P, Olbjer L. Extrusion of an effervescent granulation with a twin screw extruder, Baker Perkins MPF 50 D. Influence on intragranular porosity and liquid saturation. *Drug Dev Ind Pharm* 1988; 14:1791–1798.
29. Harrison PJ, Newton JM, Rowe RC. The characterization of wet powder masses suitable for extrusion/spheronization. *J Pharm Pharmacol* 1985; 37:686–691.
30. Landín M, Rowe RC, York P. Characterization of wet powder masses with a mixer torque rheometer. 3. Nonlinear effects of shaft speed and sample weight. *J Pharm Sci* 1995; 85:557–560.
31. Baert L, Remon JP, Knight P, Newton JM. A comparison between the extrusion forces and sphere quality of a gravity feed extruder and a ram extruder. *Int J Pharm* 1992; 86:187–192.
32. Baert L, Fanara D, De Baets P, Remon JP. Instrumentation of a gravity feed extruder and the influence of the composition of binary and tertiary mixtures on the extrusion forces. *J Pharm Pharmacol* 1991; 43:745–749.
33. Ku CC, Joshi YM, Bergum JS, Jain NB. Bead manufacture by extrusion/spheronization—a statistical design for process optimization. *Drug Dev Ind Pharm* 1993; 19:1505–1519.
34. Rowe RC. Spheronization: a novel pill-making process? *Pharm Int* 1985; 6:119–123.
35. Harrison PJ, Newton JM, Rowe RC. The application of capillary rheometry to the extrusion of wet masses. *J Pharm* 1987; 35:235–242.
36. Hicks DC, Freese HL. Extrusion and spheronization equipment. Ghebre-Sellassie I, ed. *Pharmaceutical Pelletization Technology*, Chap. 4. New York: Marcel Dekker, 1989:71–100.
37. Harrison PJ, Newton JM, Rowe RC. Flow defects in wet powder masses. *J Pharm Pharmacol* 1984; 37:81–83.
38. Harrison PJ, Newton JM, Rowe RC. Congergent flow analysis in the extrusion of wet powder masses. *J Pharm Pharmacol* 1984; 37:81–83.
39. Fechner P, Wartewig S, Fueting M, Heilmann A, Neubert R, Kleinebudde P. Properties of microcrystalline cellulose and powder cellulose after extrusion/spheronization as

- studied by Fourier transform Raman spectroscopy and environmental scanning electron microscopy. *AAPS PharmSci* 2003; 5(4):Article 31.
40. Pinto JF, Buckton G, Newton JM. The influence of four selected processing and formulation factors on the production of spheres by extrusion and spheronization. *Int J Pharm* 1992; 83:187–196.
  41. Hellén L, Ritala J, Yliruusi P, Palmroos A, Kristoffersson E. Process variables of the radial screen extruder: I. Production capacity of the extruder and the properties of the extrudate. *J Pharm Tech Int* 1992; 4:50–60.
  42. Vervae C, Baert L, Risha PA, Remon JP. The influence of the extrusion screen on pellet quality using an instrumented basket extruder. *Int J Pharm* 1994; 107:29–39.
  43. Baert L, Remon JP, Elbers JAC, Van Bommel EMG. Comparison between a gravity feed extruder and a twin screw extruder. *Int J Pharm* 1993; 99:7–12.
  44. Shah R, Kabadi M, Pope DG, Augsburg LL. Physico-mechanical characterization of the extrusion/spheronization process. Part I. Instrumentation of the extruder. *Pharm Res* 1994; 11:355–360.
  45. O'Connor RE, Schwartz JB. Extrusion and spheronization technology. Ghebre-Sellassie I, ed. *Pharmaceutical Pelletization Technology*, Chap. 9. New York: Marcel Dekker, 1989:187–216.
  46. Hasznos L, Langer I, Gyarmathy M. Some factors influencing pellet characteristics made by an extrusion/spheronization process. Part I. Effects on size characteristics and moisture content decrease of pellets. *Drug Dev Ind Pharm* 1992; 18:409–437.
  47. Hileman GA, Goskonda SR, Spalitto AJ, Upadrashta SM. A factorial approach to high dose product development by an extrusion/spheronization process. *Drug Dev Ind Pharm* 1993; 19:483–491.
  48. Baert L, Remon JP. Influence of amount of granulating liquid on the drug release rate from pellets made by extrusion spheronization. *Int J Pharm* 1993; 95:135–141.
  49. Wan LSC, Heng PWS, Liew CV. Spheronization conditions on spheroid shape and size. *Int J Pharm* 1993; 96:59–65.
  50. Mehta KA, Kislalioglu MS, Phuapradit W, Malick AW, Shah NH. Effect of formulation and process variables on porosity parameters and release rates from a multi unit erosion matrix of a poorly soluble drug. *J Control Release* 2000; 63:201–211.
  51. Dyer AM, Khan KA, Aulton ME. Effect of the drying method on the mechanical and drug release properties of pellets prepared by extrusion. *Drug Dev Ind Pharm* 1994; 20:3045–3068.
  52. O'Connor RE, Schwartz JB. Spheronization II: Drug release from drug–diluent mixtures. *Drug Dev Ind Pharm* 1985; 11:1837–1857.
  53. Mehta KA, Kislalioglu MS, Phuapradit W, Malick AW, Shah NH. Multi-unit controlled release systems of nifedipine and nifedipine: Pluronic F-68 solid dispersions: characterization of release mechanisms. *Drug Dev Ind Pharm* 2002; 28(3):275–285.
  54. Zhou F, Vervae C, Remon JP. Matrix pellets based on the combination of waxes, starches and maltodextrins. *Int J Pharm* 1996; 133:155–160.
  55. Kleinebudde P, Jumaa M, El Saleh F. Influence of degree of polymerization on behavior of cellulose during homogenization and extrusion/spheronization. *AAPS PharmSci* 2000; 2(2):Article 21.
  56. Jerwanska E, Alderborn G, Newton JM, Nystrom C. The effect of water content on the porosity and liquid saturation of extruded cylinders. *Int J Pharm* 1995; 121:65–71.
  57. Millili GP, Wigent RJ, Schwartz JB. Autohesion in pharmaceutical solids. *Drug Dev Ind Pharm* 1990; 16:2383–2407.
  58. Maganti L, Celik M. Compaction studies on pellets I. Uncoated pellets. *Int J Pharm* 1993; 95:29–42.
  59. Funck JAB, Schwartz JB, Reilly WJ, Ghali ES. Binder effectiveness for beads with high drug levels. *Drug Dev Ind Pharm* 1991; 17:1143–1156.
  60. Linder H, Kleinebudde P. Use of powdered cellulose for the production of pellets by extrusion/spheronization. *J Pharm Pharmacol* 1994; 46:2–7.

61. Fielden KE, Newton JM, Rowe RC. The influence of lactose particle size on the spheronization of extrudate processed by a ram extruder. *Int J Pharm* 1992; 81:205–224.
62. Vervaeet C, Baert L, Remon JP. Extrusion–spheronization: a literature review. *Int J Pharm* 1995; 116:131–146.
63. Tapia C, Buckton G, Newton JM. Factors influencing the mechanism of release from sustained release matrix pellets, produced by extrusion/spheronization. *Int J Pharm* 1993; 92:211–218.
64. Chien TY, Nuessle NO. Factors influencing migration during spheronization. *Pharm Technol* 1985; 4:44–48.
65. Wang C, Zhang G, Shah NH, Infeld MH, Malick AW, McGinity JW. Compaction properties of spheronized binary granular mixtures. *Drug Dev Ind Pharm* 1995; 21:753–779.
66. Nicklasson F. *Compression Mechanics of Pharmaceutical Aggregates—Studies on the Tableting of Spheronized Aggregates with Varying Composition and Porosity* Ph.D. Thesis, Uppsala University, Sweden, 2000.
67. Iloañosi NO, Schwartz JB. The effect of wax on compaction of microcrystalline cellulose beads made by extrusion and spheronization. *Drug Dev Ind Pharm* 1998; 24:37–44.
68. Salako M, Podczcek F, Newton JM. Investigations into the deformability and tensile strength of pellets. *Int J Pharm* 1998; 168:49–57.
69. Nicklasson F, Alderborn G. Modulation of the tableting behavior of microcrystalline cellulose pellets by the incorporation of polyethylene glycol. *Eur J Pharm Sci* 1999; 9:57–65.
70. Haslam JL, Forbes AE, Rork GS, Ripkin TL, Slade DA, Khossravi D. Tableting of controlled release multiparticulates, the effect of millisphere size and protective overcoating. *Int J Pharm* 1998; 173:233–242.
71. Johansson B, Nicklasson F, Alderborn G. Effect of pellet size on degree of deformation and densification during compression and on compactability of microcrystalline cellulose pellets. *Int J Pharm* 1998; 163:35–48.
72. Maganti L, Celik M. Compaction studies on pellets II. Coated pellets. *Int J Pharm* 1994; 103:55–67.
73. Miller RA, Leung EMK, Oates RJ. The compression of spheres coated with an aqueous ethylcellulose dispersion. *Drug Dev Ind Pharm* 1999; 16:1411–1426.
74. Bécharde SR, Leroux JC. Coated palletized dosage form: effect of compaction on drug release. *Drug Dev Ind Pharm* 1992; 18:1927–1944.
75. Torrado JJ, Augsburg LL. Effect of different excipients on the tableting of coated particles. *Int J Pharm* 1994; 106:149–155.
76. Beckert TE, Lehmann K, Schmidt PC. Compression of enteric-coated pellets to disintegrating tablets. *Int J Pharm* 1996; 143:13–23.
77. Haubitz H, Mehnert W, Frömring KH. Preparation of theophylline multiple units tablets. *Pharm Ind* 1996; 58:83–86.
78. Yuassa H, Takashima Y, Omata T, Kanaya Y. Studies on stress dispersion in tablets III. Suppression of fracture of coated film by an excipients during the preparation of tablets containing particles. *STP Pharm Sci* 2001; 11:221–227.
79. Stubberrud L, Eriksson M, Kordnejad K, Graffner C. Water–solid interactions. IV. Influence of moisture sorption on the compaction of film-coated particles. *Pharm Dev Technol* 1998; 3:141–151.
80. Lehmann K, Petereit HU, Dreher D. Schnellzerfallende Tabletten mit gesteuerter Wirkstoffabgabe. *Pharm Ind* 1993; 55:940–947.
81. Palmieri GF, Wehrle P, Martelli S. Drug release from compressed Eudragit RS 30D coated beads. *STP Pharm Sci* 1996; 6:118–121.
82. Wagner KG, Krumme M, Beckert TE, Schmidt PC. Development of disintegrating multiple-unit tablets on a high-speed rotary tablet press. *Eur J Pharm Biopharm* 2000; 50:285–291.
83. Tunón Á. *Preparation of Tablets from Reservoir Pellets with an Emphasis on the Compression Behavior and Drug Release*. Ph.D. Thesis, Uppsala University, Sweden, 2003.

# 12

## Effervescent Granulation

**Guia Bertuzzi**

*IMA S.p.A, Solid Dose Division, Bologna, Italy*

### 1. INTRODUCTION

Effervescent granulation is an important step in the production of fizzy dosage forms that, most of the time, cannot be avoided to achieve the desired characteristics of the effervescent tablets. It is also very critical because it can affect the stability of the final dosage forms.

The first effervescent preparations were described over two centuries ago in the official compendia; they were in powder form for use as cathartic salts. Later, in 1815, a patent described “a combination of neutral salt or powder which possesses all the properties of the medicinal spring of Seidlitz in Germany, under the name of Seidlitz Powders,” which contains sodium potassium tartarate, sodium bicarbonate, and tartaric acid, in the proportions 3:1:1, respectively (1). Effervescent granules and tablets have become more and more popular as the dosage form because they are readily soluble and easy to consume just by drinking the glass of water where they are dissolved.

To state the growing interest in such forms, in the 1980s—when electronic bibliography searching was not available yet—the results of a literature search about effervescent forms were published so as to help scientists working on new developments (2).

According to the 4th edition of the *European Pharmacopoeia*, the effervescent forms are defined as those granules or tablets that are to be dissolved in water before administration to patients. Effervescent tablets or granules are uncoated and generally contain acidic substances and carbonate or bicarbonate which reacts rapidly to release carbon dioxide when dissolved in water. Disintegration of the tablets usually occurs within 2 min or even less, due to the evolution of carbon dioxide.

Effervescent forms have many advantages over conventional pharmaceutical forms. They substitute liquid forms when the active ingredient is less stable in liquid form because they can be administered only by first dissolving the tablet in water. Active ingredients that are not stable in liquid form are often more stable in the effervescent form. Their administration is easy and is particularly helpful to patients, for instance, children, who are not able to swallow capsules or tablets. They have a pleasant taste due to carbonation, which helps to mask the bad taste of certain drugs.

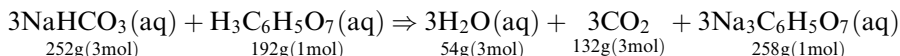
This could help to avoid the gastric side effect of certain drugs. In certain cases they can shorten drug absorption rate in the body when compared to traditional tablets, with a quicker therapeutic effect (3). They are easy to use and appeal to consumers more than the traditional dosage forms because of their color and fizzy appearance.

Disadvantages of such solid dosage forms are more related to production technology even if processing methods and equipment are the same as the conventional ones. The general product requirements are similar to conventional granules: particle size distribution and shape, uniformity of active distribution, to produce satisfactory free-flowing granules, capable of being tableted using high-speed rotary tablet press. However, it is also necessary to focus attention on some aspects of the procedure, including compression and packaging because effervescent dosage forms—irrespective of whether it is a sachet or a tablet—are larger and consequently difficult to produce.

The pharmaceutical industry has faced many problems, especially in the preparation of effervescent tablets as it is certainly the application for which the choice of the processing equipment is at least as important as the formulation design.

## 2. THE EFFERVESCENT REACTION

Effervescence is the evolution of gas bubbles from a liquid, as the result of a chemical reaction. The most common reaction for pharmaceutical purpose is the acid–base reaction between sodium bicarbonate and citric acid:



This reaction starts in presence of water, even with a very small amount as catalyzing agent, and because water is one of the reaction products, it will accelerate the rate of reaction, leading to difficulty in stopping the reaction. For this reason the whole manufacturing and storage of effervescent products has to be planned by minimizing the contact with water. Looking at the stoichiometric ratios in the reaction it is quite easy to understand the reason why effervescent tablets are so large.

Recently, some effervescent systems have been prepared that act as penetration enhancers for drug absorption, not only in oral forms but also in some topical forms, such as skin or vaginal applications. In these cases the reaction takes place directly after administration, in the mouth due to saliva (4), upon the wounds due to blood serum (5), or when formulated in a suppository. The effervescence can be provoked by the moisture of the vaginal mucosa to treat vaginal infections or by simply adjusting the pH.

There are other forms in which effervescence is based on a reaction different from carbon dioxide formation. Effervescence is due to reactants that evolve oxygen or other gases, which are safe for human consumption even if they are not suitable for oral administration but can be employed in preparations for external use such as antibacterial for dental plate cleaning.

## 3. FORMULATION

The criteria to choose the raw materials for effervescent products are not very different from those for conventional tablets, since in both cases good compressibility and compactability are the targets to be achieved.



The intrinsic characteristics of effervescent forms bring some considerations that limit the choice of the raw material, including the selection of the active ingredient. Moisture content of the raw material is a very significant aspect, because it affects compressibility and stability of the tablets. To avoid premature effervescent reaction during the process or once the tablets are formed, raw materials with very low moisture content have to be used.

Since an effervescent tablet is required to dissolve within 2 min or less in a glass of water (about 100 mL), the solubility of raw materials and their rate of solubility are other significant parameters. The active ingredient must be soluble, water dispersible, or at least solubilized by salt formation during the dissolution in the glass of water. The rest of the excipients, such as additives like sweeteners, coloring agents, flavors, also have to be water soluble.

For all the above considerations the list of the excipients has not changed since many years. However, the physical properties of these raw materials have recently improved. Many different grades for each material are now commercially available, also including also some preformulated grades, which are highly recommended for direct compression. Formulators must choose the excipient grade on the basis of the active ingredient, tablet size, and the process technology available. Therefore, the ultimate use of the effervescent granules or tablets mainly affects the choice of the raw materials.

To design an effervescent formula it is necessary to consider the stoichiometric ratios in the reaction, and the carbon dioxide solubility in water, which is 90 mg/100 mL of water (in STP conditions). The suggested ratio between acid and alkaline components is about 0.6 but sometimes it might be required to increase the acid source to get a pleasant taste. In fact, the alkali–acid ratio controls both the effervescence capacity and the taste of the solution to be administered.

When the solubility of the active ingredients is not pH dependent, the alkali–acid ratio can be optionally selected. This ratio can also be determined according to the pH that is required for dissolving the active ingredient. In fact, when the active solubility increases at the acid side, the pH of the solution is lowered by adding an excess of the acidic agent. Conversely, an excess of alkaline source must be added when the active ingredient is more soluble at higher pH (6). However, another approach that can be used to increase the active ingredient solubility is to increase the volume of carbon dioxide to be generated by increasing the alkaline component in the formulation.

As far as other excipients, such as diluents or binders, are concerned there is a very little freedom for the formulator to experiment, because of the large dimension of the tablet required for effervescent systems. In addition, compressibility cannot be enhanced by additional binders for effervescent dosage form, because of the larger size of the tablet.

In the latest development in effervescent forms, some formulations have been designed to control the rate of effervescence, so to obtain a rapid, intermediate, or slow rate. The rate control is strictly related to the acid–alkaline components ratio, but the chemical properties of the effervescent excipients or their combinations can have influence on it, especially when a slow rate of effervescence is required.

#### 4. RAW MATERIALS

Because of the nature of the effervescence reaction, additional excipients are sparingly used as the alkaline and acid ingredients also act as fillers to get a tablet bulk.

They are in a so large an amount that effervescent tablets are much larger than conventional ones. In case it is necessary to add a filler, sodium bicarbonate is the material of choice due to its lower cost and because it does not influence final pH of the solution and it also increases the effervescence effect. Sodium chloride and sodium sulfate are other possible fillers. They are high-density crystalline powders that are very compatible with the other ingredients.

Additives are added in a small amount to obtain tablets that are more attractive to users. Flavors, colors, and sweeteners are used as usual in all the formulations.

#### 4.1. Acid Materials

Necessary acidity for effervescence can be provided by three main sources: food acids, acid anhydrides, and acid salts. Citric acid, tartaric acid, and ascorbic acid are the most commonly used food acids because they are odorless, have a nice taste, are not expensive, and are easy to handle.

##### 4.1.1. Citric Acid

Citric acid is the more often used acidic ingredient because of its good solubility and pleasant taste. It is commercially available in powder form and is either colorless or exist as white crystals. The particle-size grades are: coarse, medium, fine, powder (only anhydrous). It is very soluble in water and soluble in ethanol (7). It can be used as monohydrate or anhydrate, depending on the selected equipment, technology, and process conditions. It is very hygroscopic; however, the anhydrous form is less hygroscopic than the monohydrate (8). However, caking of the anhydrous may occur upon prolonged storage at humidity >70%. The monohydrate melts at 100°C, and releases the water of hydration at 75°C. For this reason, it can be used as a binder source in hot melt granulation.

##### 4.1.2. Tartaric Acid

It is very soluble in water and very hygroscopic compared to citric acid. In the effervescence reaction with sodium bicarbonate it behaves like citric acid in producing an evident effervescence. It must be used in a higher amount to get the proper stoichiometric proportions, because it is a diprotic acid, while citric acid is a triprotic one. In terms of compressibility it is comparable to citric acid (8).

##### 4.1.3. Ascorbic Acid

It is white in crystalline form and light yellow in fine powder. It is not hygroscopic and this may be helpful in production because it is easier to handle. It is freely soluble in water (1 g in about 3 mL) and absolute ethanol (9). If exposed to light, it gradually darkens. Its behavior in the effervescent reaction with sodium bicarbonate is comparable to the other acids (citric and tartaric) in terms of release rate of carbon dioxide.

##### 4.1.4. Acid Anhydrides

Anhydrides of food acids are potential acid source as they are precursors of the corresponding acid on hydrolyzation. The effervescent effect is strong and sustained by the continuous production of acid in the solution. Water has to be avoided during

the whole process when anhydrides are part of a formulation. Otherwise they would be hydrolyzed to the corresponding acid before their use in the product (10).

#### 4.1.5. *Acids Salts*

Sodium dihydrogen phosphate and disodium dihydrogen pyrophosphate are acid salts that have been used in effervescent formulation. They are soluble in water, producing acid solution and react quickly with alkaline sources. They are commercially available either as granules or powder.

#### 4.1.6. *Other Less Frequent Sources of Acid*

- Fumaric and nicotinic acids, which are not hygroscopic, but have low water solubility.
- Malic acid has recently been introduced in effervescent formulations because of its smooth and light taste. It is highly hygroscopic and soluble but has less acid strength than tartaric or citric acids.
- Acetylsalicylic acid, though an active ingredient that is very commonly administered in effervescent preparations, cannot be used as an acid source because of its low water solubility.
- Adipic acid deserves to be mentioned even if it does not function as an acid source because of its low water solubility. It has given good results as a lubricant for effervescent calcium carbonate tablets (11).

## 4.2. Sources of Carbon Dioxide

Solid carbonates salts are the most popular source for effervescent; bicarbonate forms are more reactive than carbonates.

#### 4.2.1. *Sodium Bicarbonate*

Sodium bicarbonate is the major source of carbon dioxide in effervescent forms and is able to provide a yield of 52% of carbon dioxide. It is commercially available in five grades according to particle size, from free-flowing uniform granule to fine powder, which are odorless and slightly alkaline in taste. When heated, the bicarbonate is converted into anhydrous sodium carbonate. This reaction is time and temperature dependent. Ninety percent of the conversion is achieved within 75 min at 93°C, but dehydration starts at 50°C, which must be considered as a critical temperature in processing (12).

Being a nonelastic material sodium bicarbonate has a very low compressibility but this issue has been overcome since its production by spray-drying technique. Direct compressible grades are now available but contain some additives such as polyvinylpyrrolidone (PVP) or silicone oil.

#### 4.2.2. *Sodium Carbonate*

Sodium carbonate is commercially available in three different forms, all very soluble in water: anhydrous, monohydrate, or decahydrate (13). It is more resistant to the effervescent reaction and in some formulations can be used as a stabilizing agent in amounts not exceeding the 10% of the batch size. It is used as a stabilizing agent in certain effervescent formulas because it absorbs moisture preferentially, preventing the effervescent reaction from starting. Of course the anhydrous form is the

preferred choice for this purpose. Recently, a particular grade of sodium bicarbonate has been produced as round-shaped particles, coated with a carbonate layer to increase bicarbonate stability (14).

#### 4.2.3. *Potassium Bicarbonate and Potassium Carbonate*

They substitute the sodium salts when sodium ion is not required (15). They are less soluble than the corresponding sodium salts and are more expensive.

#### 4.2.4. *Calcium Carbonate*

Precipitated calcium carbonate occurs as fine, white, odorless, and tasteless powder or crystals. Its water solubility is very poor, and it is not soluble in ethanol or isopropanol. It is a high density powder, and thus not suitable for compression. It is normally used as a drug in effervescent tablets for patients who suffer from calcium deficiency. It can also be used as alkaline source because it provides stability to the effervescent system (16).

#### 4.2.5. *Sodium Glycine Carbonate*

Sodium glycine carbonate provides a light effervescence reaction, but causes rapid disintegration of the tablets, so it has been applied in the preparation of fast-dissolving sublingual tablets. It is much more compressible than the other alkaline compounds and has been found suitable for direct compression (17).

### 4.3. Binders

The use of a binder in effervescent formulations is limited by the fact that any binder, even if water soluble, will retard the tablet disintegration. Therefore, the amount of binder in a given formula will be a compromise between desired granule strength and desired disintegration time.

As will be described in Section 5.1.2, water itself is an effective binder for effervescent granules when granulated with all the components together. A small amount of water, very finely distributed on the powder bed, acts as a binder by partially dissolving the raw materials so that they can be agglomerated. Other solvents, ethanol and isopropanol are not binders themselves, but can be used as granulating liquids to dissolve dry binders.

Binders for dry granulation, such as lactose, mannitol, dextrose, are almost inappropriate, because they would be effective only in larger amount than that allowed by an effervescent formulations. The binder choice in wet granulation is also limited by the method of production and consequently by the amount of granulating liquid.

In case of granulation of both the alkaline and acid components together with water, it would not make sense to put a binder in the formulation because the small water amount will never be able to dissolve the binder.

The most popular binder for effervescent tablets is polyvinylpyrrolidone (PVP). Types K25 and K30 are preferred for their water solubility and dissolution rate which is an important parameter for the final purpose of effervescent tablets. PVP is effective at low percentage in the formula, starting from 2% and over. It is feasible either for dry or wet granulation. It is soluble in water, alcohols, and hydroalcoholic liquids (18).

#### 4.4. Lubricants

Because tableting is a critical step in effervescent production, selecting the lubricant is one of the most important issues. Lubrication of the effervescent mixture is quite problematic because of the chemical–physical nature of the lubricants. Most of the lubricants, because of their low water solubility, inhibit the tablet disintegration, which, as already said, must be very rapid in case of effervescent tablets. The effervescent tablets—mainly for marketing reasons—are often required to provide a clear transparent solution, that is, without any insoluble “scum” forming on the water surface, or any residue left. In selecting a lubricant, proper attention must be given to its solubility in water along with its compatibility with the active ingredient.

Many different lubricants have been tested for a long time to establish the most appropriate one for effervescent tablets (19), including the opportunity to carry out external lubrication of the granules directly in the dies of the tablet-press.

Lubricant substances which are reported in literature as suitable for effervescent manufacturing because they are water soluble are: sodium benzoate, sodium acetate, L-leucine, and Carbowax 4000. A very recent application is a combination of calcium and potassium sorbates, micronized polyethylene glycol with calcium ascorbate or trisodium citrate (20). Combination of spray-dried L-leucine and polyethylene glycol 6000 has been reported as a successful lubricant in the literature (21). Other less soluble lubricants have been used in formulating effervescent tablets, however, a balance should be found between compression efficiency and water solubility. Magnesium stearate is also employed but the most suitable, commercially available type is its combination with sodium lauryl sulfate, a surface-active agent that helps in its dispersion (22).

#### 4.5. Additives: Sweeteners, Coloring Agents, and Flavors

Coloring agents can include all the dyes soluble and suitable for food, such as those the F.D.&C. ones and all the natural coloring substances in amounts varying in the range of 0.1–3.5% of the total weight of the formulation.

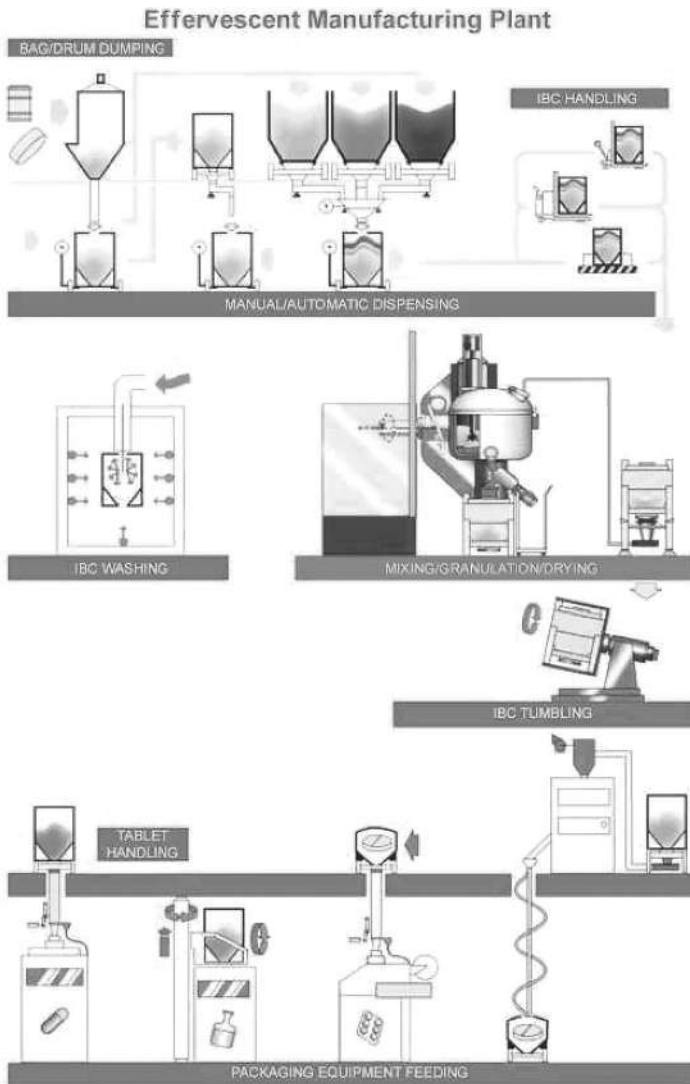
Flavors can be selected from synthetic flavors or natural extracts. Lemon, orange, and other fruit essences are particularly suitable to obtain organoleptic requirement in amounts varying from 0.5% to 3.0% of the total weight of the formulation.

### 5. MANUFACTURING OF EFFERVESCENT FORMS

Manufacturing conditions are crucially important even with regards to stability of the products after they have been packed. Almost all the raw materials used for effervescent tablet manufacturing are hygroscopic, and hence moisture absorption from the air must be prevented to avoid the effervescent reaction prior to use of the tablets.

The whole production process as shown in [Figure 1](#) (dosing of the ingredients, mixing or granulating, lubricating, tableting, and packaging) can be carried out in completely closed and integrated handling system, consisting of intermediate bulk containers (IBCs), tumblers for IBCs, docking and dosing stations.

In this case only the packaging area will be ventilated with low moisture content of air. Otherwise traditional open handling systems can be employed but the whole facility has to be conditioned with air at minimum level of moisture content



**Figure 1** Integrated production plant.

(23). In fact, the suggested conditions throughout the plant are: relative humidity (RH) below 20% and uniform temperature at 21°C. It is known, however, that 25% RH at controlled room temperature (25°C) is enough to avoid instability caused by atmospheric moisture (24).

Manufacturing effervescent drugs on a large scale is usually done using a semi-continuous procedure, by paying attention to synchronize all the process steps, in order to achieve the largest production throughput. A continuous process flow, with continuous feeding of raw materials and collection of granules, can be performed by extrusion of the wet mass and drying in a continuous fluid bed dryer. Granulation of effervescent mixtures must, most of the times, be executed in batches and is definitely the most critical step of this particular kind of pharmaceutical manufacturing, as it strongly influences the characteristics of the final forms, granules or tablets, and consequently the following steps of production. Lubrication of the granulation,

compression of tablets, and packaging of effervescent tablets should be carefully planned to produce a suitable effervescent product.

The critical issues discussed earlier, for the compression of effervescent granules, are related to the low compressibility of the majority of the raw materials, large dimensions of the tablets, poor content of binder in the formulation, and difficulties of lubricating the mixture. For all these reasons the tableting phase has to be carried out carefully, and even the choice of the tablet press is of great importance. To overcome lubrication difficulties, some suppliers of tablet press have developed equipment that is capable of carrying out external lubrication of the granules. Anti-adherent materials are sprayed directly into the dies of the tablet press, during the pause phase of compression, so as to prevent sticking of granules upon dies and punches. External lubrication is not as good a method as using lubricant substances to disperse in the granules. It is not considered the best solution for lubrication because it is considered less compliant to the standard GMP (good manufacturing practices) rules; In addition, the assembling and disassembling of the tablet press is complex. An alternative method to obtain better tablets, facilitating the compression, is to tablet the granules while they are still slightly wet, or not dried yet as we are still considering very low moisture content of <1%. Tablets are then dried and stabilized by means of a process step in a static ventilated oven.

Packaging operations for both granules and tablets must be done, as already mentioned, in a low humidity environment. The critical aspects about packaging of effervescent drugs are obviously related to stability of the tablets and granules and the main objective is to protect them, as much as possible, not only during packaging operations but also after they are packed, so as to impart a reasonable shelf-life. The oldest packaging method for effervescent preparations consisted of wrapping the acid and alkaline components separately, to avoid the premature effervescent reaction until use. All the effervescent drugs can be packed in individual dose units, in airtight containers made of protective aluminum foil or plastic laminates. Tablets can also be packed by stacking them one by one in plastic or metal tubes, which have almost the same diameter of the tablets so as to minimize the air which remains in contact with the tablets. The tubes must be resealed every time, after taking out each tablet.

Certain tablets are also wrapped in an aluminum foil before packaging in the tube and this seems to be the best solution for long-term stability. Patented types of tubes containing silica-gel in the internal side of the cap are the most recent invention (25).

For tablets that are packed in strips, it is essential that the packaging machine has a fine control over the temperature of the welding unit, so that an accurate sealing of the strips can be obtained and overheating phenomenon that could provoke release of residual water from the tablets can be avoided (24).

## 5.1. Granulation Methods

Two main granulation methods have been known for a long time. The 1911 edition of the *British Pharmacopoeia* reported a detailed description of the manufacturing procedure (26).

Effervescent granules are made by mixing citric and tartaric acids with the medicament, and the sodium bicarbonate with the sugar when present; and then thoroughly mixing the one with the other, and granulating the resulting mixture by stirring in a pan heated to between 93° and 104°, passing through sieves of

a suitable size, and drying at temperature not exceeding 54°. This method for preparing the granules yields satisfactory results but the following alternative method has also been suggested: Mix the sodium bicarbonate, the sugar, and the medicament, pass the mixture through a No 20 to No 30 stainless steel sieve, subject the mixed acids to the same process, and thoroughly mix the two sifted powders. Place the mixed powders in layers on suitable dish, pan or glass tray, heated to 75° to 85°, if required but not exceeding the higher temperature. When the mass, after being suitably kneaded and compressed, has assumed a uniform plastic condition, suitable for granulation, rub it to a No 5 to No 10 stainless steel sieve, according to the size of granules desired, and dry the granules at a temperature not exceeding 50°.

Only a few aspects have substantially changed in the modern methods. Two main methods can be executed with various types of granulation equipment:

- a. *Single-step method.* All the components of an effervescent formula are granulated together, handled with care, running the process in a contained manner to maintain the stability of the mixture until the step is completed. This single-step method is normally carried out using dry granulation, hot-melt granulation, and certain wet granulation processes.
- b. *Multistep method.* The alkaline and the acid components are granulated separately, then mixed together, just before the tableting or packaging step. Usually these are also typical applications of wet granulation technologies.

#### 5.1.1. Dry Granulation

Dry granulation by roller compactor is definitely the most appropriate method for its simplicity, low costs, and higher product throughput. The number of operations and space required are less and consequently, air ventilation is reduced. On the other hand, not all the excipient grades are suitable for such a technology. More sophisticated grades, and thus expensive, pre-prepared by raw material bulk suppliers are required.

An alternate process to dry granulation is direct compression of the blend of all the raw materials, in the attempt to avoid operating and stability problems. It would be the ideal process for effervescent tablet manufacturing, but its application is limited to a few cases, for example, when the active ingredient cannot be granulated (e.g., when it is already included in a complex like with a cyclodextrine), or contains some water of crystallization.

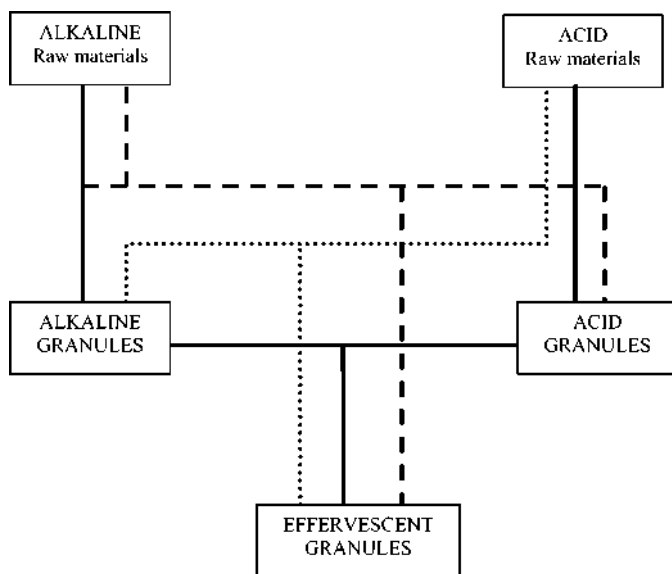
#### 5.1.2. Wet Granulation

Despite some disadvantages, wet granulation is still the most preferred method for effervescent granulation. As required for conventional tablets, this method assures homogeneous granules, suitable for compression, and is able to provide uniform tablets either in terms of weight or active ingredient content.

For this technique, it is necessary to use a granulating liquid that might interact with the powders initiating the effervescent reaction. Hence it is essential to handle the process with great care.

A wet granulation process in two separate steps is mostly recommended and suitable for conventional equipment like high-shear granulator-dryer and fluid bed processor. Acidic and alkaline ingredients are granulated separately. The two granules are then mixed together, just before adding the lubricant for tableting. Water,





**Figure 2** Alternative granulation processes.

alcohols, or hydroalcoholic solutions can be used as a binding liquid because this process is a standard wet granulation process. The usual procedure is to granulate only one of the effervescent sources and add the other one in powder in the final blending. All these possibilities are illustrated in Figure 2.

In certain cases only the acid components of the formulation are granulated and then mixed with the sodium bicarbonate, preferably when it is of fine granular grade. Other additives such as flavors and lubricants can then be added and mixed. This approach increases productivity and reduces costs since one granulation step has been eliminated.

The peculiar process that distinguishes effervescent granulation consists in a single-step granulation of all the components of the formulation, which can be performed either with nonreactive or reactive liquids with reference to the effervescence reaction.

### 5.1.3. Single-Step Granulation

Single-step granulation process provides dry effervescent granules directly by granulating the acid and the alkaline materials together. It is possible to use only water as the granulating liquid, thus controlling the effervescent reaction to granulate. A nonreactive liquid like absolute ethanol or isopropanol can also be used, but in this case it is necessary to use a binder to agglomerate the raw material particles.

**5.1.3.1. Process with Water.** A very small amount of water, less than 1% of the batch size, can be used to initiate the effervescent reaction. Some carbon dioxide is released, but some water too, which acts as the binding liquid as well. It takes a few minutes (from 5 to 10 min) to obtain wet granules. The effervescent reaction rate rapidly increases and becomes difficult to stop; it must however be terminated very quickly otherwise no product will remain. An immediate start of the drying of the granules will control and stop the effervescent reaction. For single-step technology, both fluid bed granulator and high-shear granulator-dryer are suitable.

In high-shear granulator-dryer technology it is possible to suddenly switch to drying phase by creating vacuum inside the bowl, just after the granulation phase when wet granules are well massed. Vacuum is created in a few seconds, which immediately provokes the decrease of the water boiling point down to about 20°C. At the same time the bowl is heated up to provide more energy for water evaporation. The water released on the granules surface is removed within a few seconds and the effervescent reaction stops.

The application of microwave radiation, combined with vacuum inside the bowl of the high-shear granulator (27), can also be used to stop the effervescent reaction and to dry the effervescent granules (28).

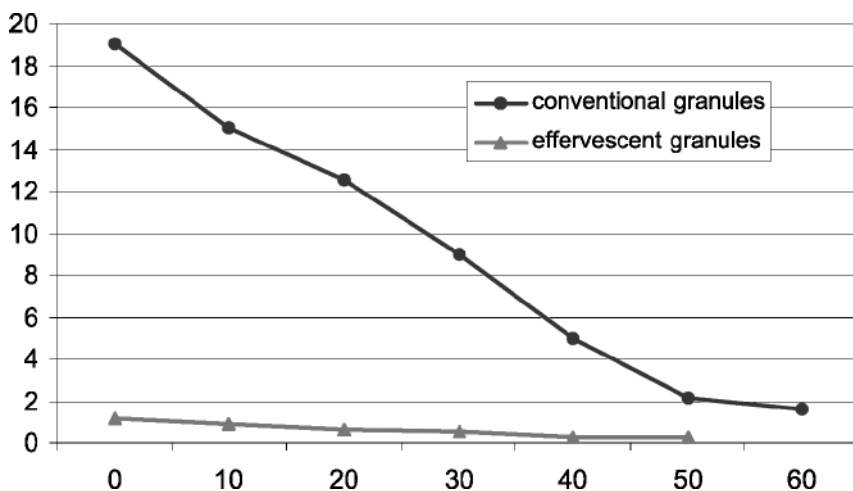
Drying of effervescent granules is a shorter process than drying conventional granules granulated with water, because of the very small amount of water involved in the process. However, drying still remains a critical step since it is very hard to remove, even the small quantity of water, from hydrophilic or hygroscopic materials. Typical drying time is about 50 min for 20 kg batch of effervescent granulation under vacuum. See Figure 3 for comparison of drying of conventional and effervescent granules by vacuum technology.

Drying rate for effervescent granules is lower because the moisture content to be removed is in a range below 2% of the batch size. Consequently, the drying time, passing from pilot scale to industrial scale, does not increase as much as for conventional granules (Fig. 4).

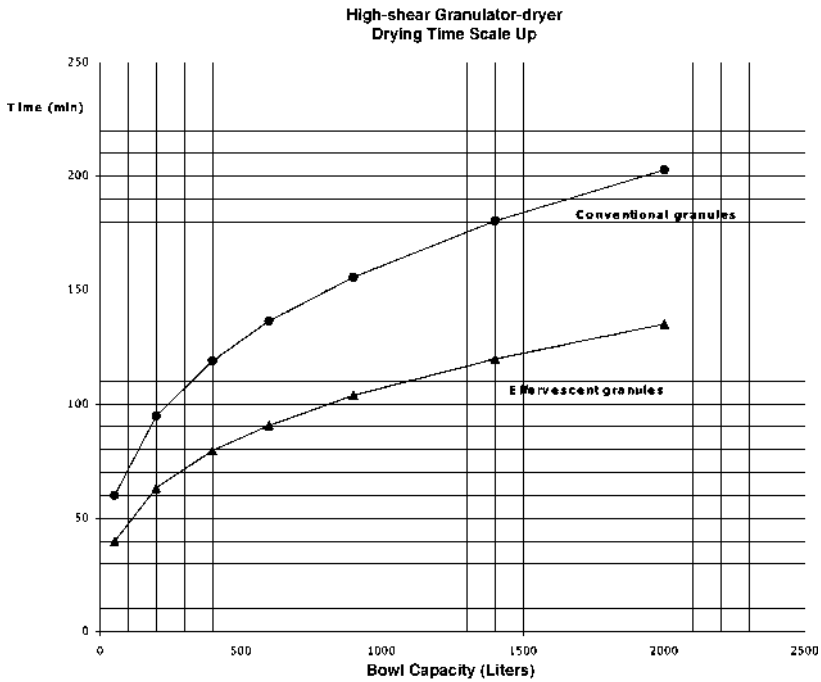
The great advantage of this method for effervescent tablet preparation lies in the installation of equipment that does not require explosion-proof systems. An example of effervescent aspirin produced in 600 L high-shear granulator-dryer equipped with vacuum and tilting bowl (29) is shown in Figure 5.

The formulation consists of:

Anhydrous citric acid	116.6 kg
Sodium bicarbonate	154.2 kg
Sodium carbonate	39.2 kg
Acetylsalicylic acid	50 kg



**Figure 3** Drying rate of effervescent granules, compared to conventional granules.



**Figure 4** Drying time scale up for high-shear granulator-dryer.

First, the effervescent system is granulated with very small amounts of water (2–4 mL/kg) and sprayed in very fine droplets. The acetylsalicylic acid is added later, in the final blending, after granulation is completed. The results of three batches are reported in [Table 1](#).



**Figure 5** “Rotocube” high-shear granulator-dryer equipped with vacuum and tilting bowl.

**Table 1** Granules Produced with Single-Step Technology in a High-Shear Granulator-Dryer

Batch code	Batch size (kg)	Yield		Results of samples			
		kg	%	Sampling time (min)	Moisture content ( $\leq 0.1\%$ )	Acid neutralizing power ( $\geq 185$ mL 0.1 N acid/tablet)	pH (6.0–6.4)
Batch #1 granulated with 720 mL of water (2 mL/kg)	360	352.2	97.80	30	0.048%		
				60	< 0.01%		
				90	< 0.01%	244.6	6.1
Batch #2 granulated with 1440 mL of water (4 mL/kg)	360	336.4	93.44	30	< 0.01%		
				60	< 0.015%		
				After discharge	< 0.01%	244.6	6.4
Batch #3 granulated with 1440 mL of water (4 mL/kg). Note: no tilting of the bowl while drying	360	323.5	89.86	60	0.075%	229.8	
				After discharge	< 0.01%	245.5	6.25

The lower yield of the third batch is due to product sticking to the walls of the bowl, which could not be discharged. The reason why it happened is related to the set parameters during drying phase: in batch #3, drying was performed by keeping the bowl static, instead of tilting it as in the other batches. The batch size in actual production was then increased to 644 kg in 1400 L equipment.

All the components of an effervescent mixture can be granulated together in a single-step process in a conventional fluid bed granulator-dryer. Granulation occurs when water is sprayed on the fluidized bed, initiating the effervescent reaction. The reaction is stopped when water is not sprayed anymore and drying phase is carried out with warm dry air. It is quite understandable that this method is difficult to control and reproduce (30). A subsequent patent application (31) describes an improvement of the method reproducibility, which can be achieved by controlling the air humidity (it has to be less than  $1 \text{ g/m}^3$ ), using an hydroalcoholic solution instead of water. Even better results in controlling the effervescent reaction are achieved when spraying and drying phase are combined together.

It is, however, very difficult to reproduce such a process. Therefore, an alternative procedure to manufacture effervescent granules has been invented using a rotor fluid bed spray-granulator (32).

Warm air, which is the only method available for drying in fluid bed technology, is not capable of stopping the reaction all at once as it happens by applying vacuum inside the processing bowl. Therefore, the only way to proceed is to minimize in some way the contact between the two components of the effervescent system. An intelligent and brilliant hypothesis put forward by Professors P. Gautier and J.M. Aiache (32) is to alternate the granulation of the acid materials with that of alkaline materials while still using a single equipment such as a rotary fluid bed system. In the literature a vitamin C formulation is reported to explain this technique but other active ingredients can also be used (33).

The process consists of two or three continuous steps to produce effervescent spheres by layering the acid components over alkaline spheres or vice versa. The binding liquid is, however, a hydroalcoholic solution in which PVP the binder must be previously dissolved.

The first step is the granulation of alkaline components in the rotary fluid bed. In the second step, the granulating solution is sprayed in combination with the acidic powders, which deposit on the alkaline spheres creating an external acid layer separated by a neutral layer of the binder. When agglomeration is completed, drying phase with hot air starts with no interruptions (32).

**5.1.3.2. Process with Alcohol or Hydroalcoholic Solution.** As reported in the previous example, it is sometimes preferable to granulate with a hydroalcoholic solution to initiate a lighter effervescence so as to keep the reaction under better control during the process. Use of alcohols is indispensable in case a binder like PVP is included in the formulation. In fact, the amount of water required to dissolve PVP to obtain the binding action will be too high, and it will not be possible to keep the effervescent reaction under control.

As already suggested for a conventional granulation process that requires the use of an inflammable liquid, it is convenient to install fully explosion-proof equipment with an accessory solvent-recovery utility that will limit the emission of vapors in the atmosphere. Solvent recovery will be more advantageous while drying under vacuum than with a fluid bed.

Certain high-shear granulator-dryers are equipped to achieve 99% of solvent recovery by installing a tank to collect the condensate, and by bringing down the possible residual exhaust with a shower of water.

#### 5.1.4. Hot Melt Granulation

Hot melt process is an alternative technology to wet granulation (which is discussed in detail in another chapter of this book). Agglomeration of the particles of a powder mixer can be achieved by melting hydrated citric acid so as to release the hydration water which acts as the granulating liquid. Once granules are formed it is necessary to cool them to achieve the proper hardness and mechanical stability. There are two different techniques:

- Surface hot melt granulation (SHMG), which consists of mixing all the raw materials together in a blender and then drying the mix in a tray oven at 90°C. Water is then released from citric acid and other ingredients to form granules (34). Unfortunately, batch reproducibility of this method is very low.
- Hot melt granulation is normally carried out in high-shear granulator-dryer with the capability to heat up the bowl. In certain cases the released water of hydration of citric acid initiates the effervescent reaction to produce additional water which acts as the binding liquid. However, this process for obvious reasons is difficult to control. The same process has been applied to fluid bed spray-granulator where low melting point polymers, like polyethylene glycols (PEGs) or polyoxyethylene glycols can also be used as binders (35).

**5.1.4.1. Hot Melt Extrusion.** Hot melt extrusion is a recent patented method to produce effervescent granules, especially dedicated to produce granules having a controllable rate of effervescence (36). The formulations for this technology must contain a hot-melt extrudable binder. Preferred binders are the polyethylene glycols with molecular weight in the range 1000–8000 Da, but some other polymers have been investigated. Binder percentage varies according to the formulation in a range of 20–40% of the total weight. There are two main extrusion techniques to carry out in extruders that must be equipped with a solid conveying zone, multiple separate temperature controllable heating zones, and an extrusion die:

- a. A blend of all the ingredients, including the active ingredient of the formulation, is hot-melt extruded at high temperature, in order to melt or soften the binder. The extrudate is then ground or chopped to obtain effervescent granules.
- b. The acidic agent and the hot-melt binder are formulated in the right proportions to obtain an eutectic mixture that has decreased the melting point temperature. This binary mixture is separately melted, the alkaline agent is added as powder in the next step. The melted mixture is then extruded, chopped, or ground as in the previous method.

To control the effervescence rate of the final dosage form, it is possible to adjust some parameters like the temperature and the rate of extrusion. The temperature range selected can be critical because degradation of the active agent may occur alongside decomposition of the effervescent components. This range is usually from about 50°C to about 120°C.

**Table 2** Manufacturing Process for Effervescent Tablets

Process	Dry granulation		Granulation by heating		Wet granulation	
	Slugging or laminating	Direct Compression	Surface hot melt granulation	Hot melt granulation	Granulation + drying (two steps)	Granulation + drying (one step)
Equipment	Blender + tablet press compactor	Blender	Blender + tray dryer	Single-pot mixer-granulator-dryer	Mixer + fluid bed dryer	Single-pot mixer-granulator-dryer
Number of steps	6	3	6	5	6	4
Estimated time (h)	23	10	22	14	15	12
Advantages	Fast process	No product transfers	No granulating liquid	No product transfers	Batch reproducibility	Batch reproducibility
Disadvantages	No product transfers	No granulation	Totally closed	No granulating liquid		
	No granulation	Short time				
	Raw materials at low residual moisture	Raw materials for direct compression at low residual moisture (more expensive)	Loss of effervescence	Difficult to carry out	Difficult to clean	Difficult to clean
	Dusty process		Long time	Difficult to clean		
	High manpower required		Dusty process			
			High manpower required			
Note		Obsolete	Rarely applied			

The rate of extrusion is related to the time of materials exposure to high temperature which is usually less than 5 min.

The hot-melt extrusion technology in some cases can be run as a continuous process, having a higher throughput than batch hot-melt granulation process per batches.

All the previous sections provided an overview of all the possible technologies to manufacture effervescent granules but how to choose the most appropriate technique for a certain formulation. An interesting study to figure out the best production method for effervescent tablets was presented by Laugier and Rona (Table 2) (37).

Three technologies were evaluated: dry granulation, hot melt granulation, and wet granulation. The choice of the process technology was strictly related to the physical properties of the raw materials, namely particle size, density, flowability, and moisture content. Moisture content is definitely the most significant parameter since the powder mixture has less than 0.2–0.3% of moisture content. It would be stable but difficult to tablet and pointing such a situation, a wet granulation process is required.

The use of high-shear granulator-dryer has been found as the more economic and flexible production method by other researchers (38) as well. This technology allows us to use a wider range of excipient grades, avoiding problems related to particle size or moisture content of the raw materials. Even if the granules produced by this technology appear finer, their flow properties are good despite the large fraction of fine-sized particles. Tableting properties are always in line within the specifications.

## REFERENCES

1. Homan P. Pharm J 2001; 267:911–936 (<http://www.pharmj.com>).
2. NCF. December 1984 pp. 19–22; May 1985 pp. 21–23.
3. Moller PL, Norholt et al. J Clin Pharmacol 2000; 40(4):370–378.
4. US Patent 6,200,604, 1999.
5. Rapp M. PCT Int Appl 2000.
6. US Patent 6,077,536, 1998.
7. Handbook of Pharmaceutical Excipients. Washington/London: The American Pharmaceutical Association/The Pharmaceutical Society of Great Britain, 1986:78–80.
8. Schmidt PC, Brögmann B. Dtsch Apoth-Ztg 1987; 127:991–997.
9. Handbook of Pharmaceutical Excipients. Washington/London: The American Pharmaceutical Association/The Pharmaceutical Society of Great Britain, 1986:6–8.
10. Repta AJ, Higuchi T. J Pharm Sci 1969; 58:1110–1113.
11. Romaco Zanchetta R&D Laboratory archive.
12. Handbook of Pharmaceutical Excipients. Washington/London: The American Pharmaceutical Association/The Pharmaceutical Society of Great Britain, 1986:263–265.
13. Handbook of Pharmaceutical Excipients. Washington/London: The American Pharmaceutical Association/The Pharmaceutical Society of Great Britain, 1986:436–438.
14. SPI Pharma Group. Fall 2001.
15. Duvall RN, Gold, G. Miles, Inc., USA, 1990, 6 pp.
16. US Patent 6,242,002, 1999.
17. US Patent 6,284,272, 1999.
18. Handbook of Pharmaceutical Excipients. Washington/London: The American Pharmaceutical Association/The Pharmaceutical Society of Great Britain, 1986:234–239.



19. Strickland WA Jr, Higuchi T, Busse L. *J Am. Pharm. Assoc. (Sci. Ed.)*, 1956; 45:51–55.
20. Daher LJ. Bayer Corporation, USA. US Patent 1999, 6 pp.
21. Rotthaeuser B, Kraus G, Schmidt PC. Pharmazeutisches Institut, Eberhard-Karls-Univ., Tuebingen, Germany. *Pharmazeutische Industrie* 1998; 60(6).
22. Rudnic E, Schwartz JB. *Oral Solid Dosage Forms*, Chapter 45, Tablets, 861, Remington.
23. Armandou J-P, Mattha AG. *Pharm Acta Helv* 1982; 57:287–289.
24. Mohrle R. Effervescent tablets. Lieberman HA, Lachman L, eds. *Pharmaceutical Solid Dosage Forms*. Vol. 1. New York: Marcel Dekker, 1980:225–258.
25. [http://www.desiccantcity.com/CASE\\_HISTORIES/History11.htm](http://www.desiccantcity.com/CASE_HISTORIES/History11.htm).
26. The British Pharmaceutical Codex. Published by direction of the Council of the Pharmaceutical Society of Great Britain, 1911 (<http://www.scocca.org/herbmed/eclectic/bpc1911/granulae.html>).
27. *Collette News* Vol. 2, Issue 1, May 2001, GEA Powder Technology Division.
28. Aiache JM, Cardot JM. Utilisation des micro-ondes dans la fabrication des formes pharmaceutiques. Conf. INSA Roehuen, 1999.
29. Romaco Zanchetta R&D Laboratory Archive.
30. Coletta V, Kennon L. *J Pharm Sci* 1964; 53:1524–1525.
31. Patent EP 673,644.
32. Gauthier P, Aiache J-M. *Pharm Technol Eur* 2001; 13(10):32 (see also p. 34 and pp. 36–37).
33. US Patent 6,210,711, 1999.
34. Yanze FM, Duru C, Jacob M. Laboratoire de pharmacie galenique, pharmacotechnie et de Biopharmacie, Universite Montpellier I, UFR de Sciences Pharmaceutiques, Montpellier, France, *Die pharmazie* 12/2000.
35. Yanze FM, Duru C, Jacob M. *Drug Dev Ind Pharm* 2000; 26(11):1167–1176.
36. US Patent 6,488,961, 1999.
37. Laugier M, Rona R. *PMPS Spring* 2002:26–28.
38. Pearlszig DM. Simulation Modeling Applied to the Single Pot Processing of Effervescent Tablets. Master's Thesis, North Carolina State University, Raleigh, NC.

# 13

## Melt Granulation and Pelletization

**T. W. Wong**

*Faculty of Pharmacy, University of Technology MARA, Selangor, Malaysia*

**W. S. Cheong and P. W. S. Heng**

*National University of Singapore, Singapore*

### 1. INTRODUCTION

Melt granulation and melt pelletization are agglomeration processes that have gathered increasing interest in the pharmaceutical industry for the concept of utilizing a molten liquid as a binder. Unlike the conventional use of aqueous or organic solvents as binders, the binding liquid in melt processes remains as a constituent of the formulation. However, the basic principles in melt agglomeration processes are relatively similar to those of wet agglomeration processes with solvents except that the interpretation of the melt agglomeration processes is not complicated by an evaporation of the molten binding liquid.

#### 1.1. Overview of Agglomeration

Agglomeration is one of the key pharmaceutical manufacturing processes concerning the conversion of fine solid particles into larger entities by agitating the fine solid particles in the presence of a binding liquid using equipment such as tumbling drum, fluid bed granulator, and high-shear mixer. The agglomeration is considered as a wet process because a binding liquid is required for the wetting of solid particles prior to agglomeration. The agglomerates formed have a specific mean size and shape, improved flowability and mechanical strength, narrow bulk density and porosity values, as well as, a modified drug release rate (1,2). Agglomerates can be classified into two types: granules and pellets, based on their physical characteristics. Granules are irregularly shaped agglomerates which have a rather wide size distribution, typically within the range of 0.1–2 mm. Pellets are spherical agglomerates with a narrow size distribution, within the range of 0.5–2 mm. Traditionally, the binding liquid required for agglomeration of fine solid particles is aqueous or organic solvent. The solid particles are held together by the binding liquid which provides temporary binding force by means of liquid bridges, and subsequently by solid bridges of the residual solute after the removal of solvent by evaporation. The hardness of solid bridges largely determines the strength of the dried agglomerates (3).

The solid bridges can also be formed by the resolidification of molten material. This is the basis by which meltable materials can be used as a binder in agglomeration.

## 1.2. Development of Melt Processes

The concept of using molten binding liquid for agglomeration instead of the conventional binding liquid prepared from aqueous or organic solvent that has to be evaporated off after agglomeration is completed was reported in some research findings in the late 1970s and early 1980s (4–6). However, the concept was not widely studied until more than a decade later and the period thereafter, using high-shear mixer and fluidizing granulator as the processors for melt agglomeration (7–27). High-shear mixer has gained greater popularity for use in melt agglomeration than other equipment such as coating pan (4), drum granulator (28,29) or extruder (30–34) for it provides intense shear forces from the high-speed rotation of the impeller. The impeller mixing action facilitates a more homogenous distribution of molten binding liquid, leading to the formation of agglomerates with narrower size distribution and uniform drug content. In addition, the meltable binder can be brought to melting by the frictional heat generated from the high shearing forces of the impeller, without external heat supply (8). Highly spherical pellets can be produced by a continuous agglomeration and rounding effect of the high-speed impeller rotation in a high-shear mixer.

The characteristics of melt agglomerates such as size, size distribution, and shape change progressively with variations in processing and formulation parameters. The melt agglomeration process can be broadly classified as melt granulation or melt pelletization, based on the physical properties of the formed agglomerates (35). For simplicity of presentation, melt agglomeration will be used as the term representing both melt pelletization and melt granulation, and melt agglomerates as the term for their resultant products in this discussion.

## 1.3. Requirement of Melt Agglomeration

Melt agglomeration is carried out by adding the binder to the fine solid particles either in the form of a molten liquid or in the form of a solid that melts during the process. Generally, an amount of 10–30% w/w of binder, with respect to that of fine solid particles, is used. The melting temperature of solid binder can be achieved by external heat supply or heat generated from interparticulate friction during high-speed mixing in the processor. A meltable binder suitable for melt agglomeration has a melting point typically within the range of 50–100°C. Meltable binders with melting point lower than 50°C are generally unsuitable as the end products are liable to melting, softening, or sticking during handling and storage. On the other hand, binders of high melting temperatures are not desirable due to greater risks of thermal instability to the drugs used when very high heat is required for the melting of the binders. The meltable binder can be classified as hydrophilic or hydrophobic. Examples of hydrophilic binders include polyethylene glycols and poloxamers. Hydrophobic binders include fatty acids, fatty alcohols, waxes, and glycerides. Hydrophilic meltable binders are used to prepare immediate-release dosage forms while the hydrophobic meltable binders are preferred for prolonged-release formulations. One or more meltable binders may be employed in the formulation of a batch of melt agglomerates. The binding action of meltable binders can be manifested through liquid bridges formed by the molten liquid. Alternatively, a softened

semisolid can act as a binder (6,36). The local melting zone on the surface of a semisolid binder could promote particle aggregation and subsequently agglomerate growth. Nonetheless, a higher binder content up to 50% w/w was possible as there was less binding liquid available for agglomerative action for a given weight of meltable binder (6). Furthermore, the process of melt agglomeration is less sensitive to the level of binder when softened semisolid is used as a binder. Frequently, the process of agglomeration which employs softened semisolid binder is termed as thermoplastic agglomeration.

The fine solid particles can be organic or inorganic in origin and in melt agglomeration studies, inert substances commonly employed are lactose and dicalcium phosphate. The melting point of fine solid particles should be at least 20°C higher than that of the maximum processing temperature. This prevents excessive softening of the solid particles as they form the support for the molten binding liquid during the building-up process of agglomerate structure. The fine solid particles may be constituted by one or more components. The physicochemical characteristics of both meltable binders and nonmeltable fine solid particles have crucial effects on the outcome of a melt agglomeration and will be discussed in Section 3.

#### 1.4. Advantages of Melt Agglomeration

The growing interest in melt agglomeration has largely been attributed to various advantages of melt agglomeration which are not attainable using the conventional wet agglomeration techniques. With an appropriate selection of meltable binders, both immediate- and prolonged-release agglomerates can be prepared using a one-step, one-processor approach (14,37–42). Melt agglomeration is applicable for processing of water-sensitive materials such as effervescent excipients and hygroscopic drugs, thus omitting the use of either aqueous or organic solvent (43,44). With melt methods, organic solvent, flame-proof facilities, and solvent recovery equipment are not required, giving rise to lower cost of operation, and reduced ecological and toxicological hazards. In addition, the formative process of melt agglomerates does not require a drying phase and this shortens the total processing time. Melt agglomeration is an ideal model for the elucidation of an agglomeration process as the process of particle binding is not complicated by an evaporation of molten binding liquid unlike the aqueous and nonaqueous wet agglomeration. Moreover, the physicochemical properties of the molten binding liquid are potentially modifiable by incorporating an additive (45).

Despite the various advantages offered by melt agglomeration, the technique is not suitable for processing of heat-labile materials due to the involvement of elevated temperatures. Nonetheless, successful agglomeration of volatile substances with almost complete prevention of material loss by vaporization has been reported (46). The probable reason is that the agglomerate surfaces were covered by layers of solidified molten binder and loss of volatile substances was further avoided since the melt process was in a closed chamber. In addition, *Lactobacillus acidophilus* bacteria were found to have a higher survival rate in formulations prepared by continuous melt technology than in formulations prepared using conventional wet techniques, in spite of the molten mass' temperature rising to more than 100°C (47). Clearly, the detrimental effects of heat were considerably reduced by the absence of moisture in melt agglomeration.

The growth processes of melt agglomerates are highly sensitive to formulation, processing, and equipment variables. Uncontrollable melt agglomeration is

frequently encountered when such variables are not optimally adjusted. In view of challenges in controlling the melt agglomeration process, melt agglomeration has remained an interesting field of research with the potential for practical and wider application in the pharmaceutical industry.

### 1.5. Characterization of Melt Agglomerates

Over the past decade, many researchers have examined the effects of formulation, processing, and equipment variables on melt agglomeration process through physicochemical characterization of the formed agglomerates. This has contributed to a better understanding of the formation and growth processes of melt agglomerates. Similar to agglomerates produced by wet techniques, the most common method employed for the characterization of melt agglomerates is the determination of mean agglomerate size and size distribution by sieving. The size and size distribution of melt agglomerates generally fit a log-normal mathematical model. They can be represented by geometric weight mean diameter ( $d_{gw}$ ) and geometric standard deviation ( $s_g$ ), respectively, as described by Schaefer and Worts (48):

$$\log d_{gw} = \frac{\sum w_i * \log d_i}{\sum w_i} \quad (1.1)$$

$$\log S_g = \sqrt{\frac{\sum w_i (\log d_i)^2 - (\sum w_i * \log d_i)^2}{\sum w_i}} \quad (1.2)$$

where  $d_i$  is the mean diameter and  $w_i$  is the weight of agglomerates of sieve fraction  $i$ .

Alternatively, the size and size distribution of melt agglomerates can be expressed as the model independent mass median diameter and span, respectively. The mass median diameter is defined as agglomerate size corresponding to the 50th weight percentile of the cumulative agglomerate size distribution and span being the quotient of difference between the agglomerate sizes corresponding to the 90th and 10th weight percentiles of cumulative size distribution to mass median diameter. The percentages of fines and lumps, generally described with respect to agglomerate fractions smaller than 90–250  $\mu\text{m}$  and larger than 2000–4000  $\mu\text{m}$ , respectively, are also reported as an indirect quantitative input on size distribution of melt agglomerates.

Apart from size and size distribution of melt agglomerates, shape, surface morphology, specific surface area, moisture content, density, porosity, tensile strength, friability, flow, and packing properties have often been determined in elucidation of the mechanism and kinetics of melt agglomeration. The distribution of binder content in melt agglomerates has a strong bearing on the homogeneity of melt agglomerate growth. The actual binder content in melt agglomerates has also been measured directly through experiments or estimated indirectly via the application of mathematical modeling. A direct measurement of polyethylene glycol content was determined using near-infrared spectrophotometry (20). The content of binder in melt agglomerates was also determined with the aid of the high-performance liquid chromatography analytical method (49). The polyethylene glycol content was indirectly measured from the true density values of milled agglomerate fraction determined by means of a gas displacement pycnometer (50) and the polyethylene

glycol content was calculated using Eq. 1.3 as follows:

$$\frac{(1-x)}{\rho_1} + \frac{x}{\rho_b} = \frac{1}{\rho_a} \quad (1.3)$$

where  $x$  is the fraction of polyethylene glycol,  $\rho_1$ ,  $\rho_b$ , and  $\rho_a$  are true density values of lactose, binder, and melt agglomerates, respectively. The content of polyethylene glycol can also be determined through gravimetric analysis whereby the weight of binder is obtained by weight subtraction of nonbinder fraction from that of the melt agglomerates (51,52). In the case of complexation and crystallite behavior of drug, binder, and fine solid particles, the melt agglomerates have often been subjected to evaluation by differential scanning calorimetry and x-ray diffractometry. In vitro dissolution studies have been conducted to examine the drug release characteristics of melt agglomerates. El-Shanawany (53) and Voinovich et al. (39) found that the in vivo drug release attributes of melt agglomerates were in accordance with the in vitro findings. Nonetheless, a quantitative relationship between the in vivo and in vitro performances of melt agglomerates is still generally lacking.

Another important feature of melt agglomerates is their performance stability during storage. It was found that the melt agglomerates could maintain their dissolution profile after a year of storage at 25°C and 60% relative humidity (40). The release of sulfamethazine from tablets made of melt granules remained unchanged after 2 years of storage at 25°C in closed containers (37). Nevertheless, the rate and extent of drug release were found to increase with agglomerates stored at an elevated temperature of 40°C and at a relative humidity of 75%, probably owing to the softening of the melt matrices (41,54). On the basis of the meltable nature of agglomerates, stability testing is preferred to be conducted at an appropriate choice of storage temperature which will not bring about marked alterations to the physicochemical state of the agglomerates.

## 2. MECHANISM OF MELT AGGLOMERATION

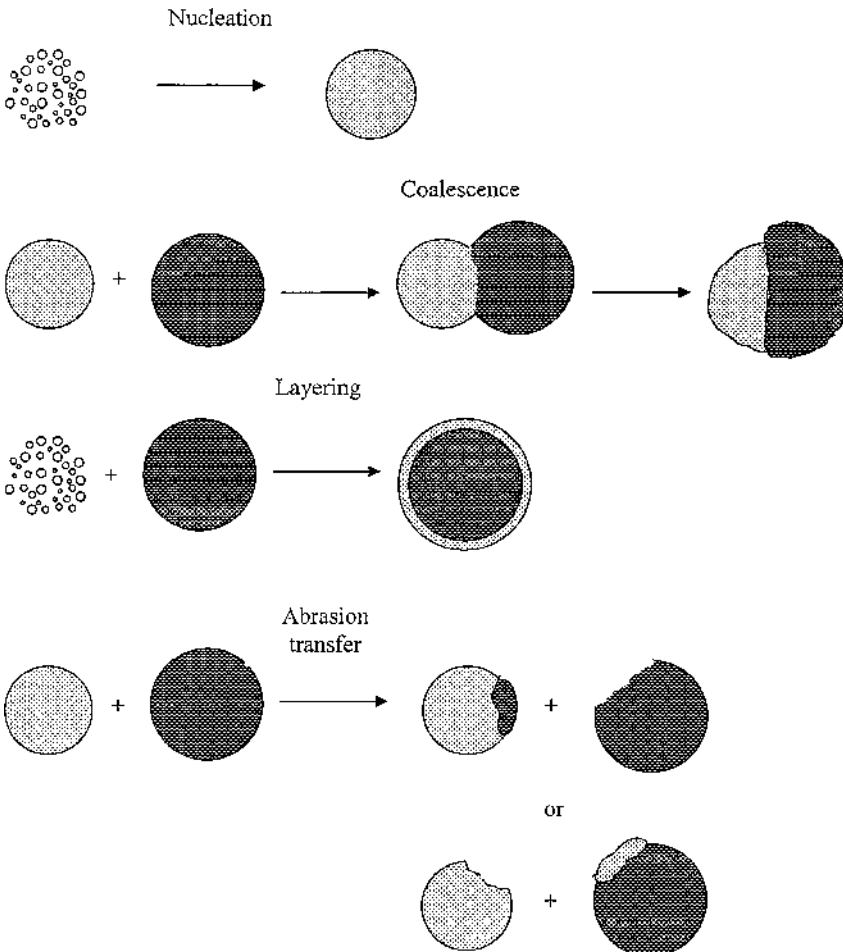
The mechanism of melt agglomeration is similar to that of wet agglomeration, except that the formation and growth processes of melt agglomerates are not complicated by binding liquid losses via evaporation during the agglomeration process. The growth process of melt agglomerates is dependent on the interplay between the size enlargement and size reduction processes. The likelihood of an agglomerate to grow in size or experience breakages is a result of the balance between externally applied mechanical forces and agglomerate strength. The agglomerates will grow in size if they have sufficient strength to withstand the impact of externally applied forces or vice versa. The strength of agglomerates is affected by the relative magnitude of capillary, frictional, and viscous forces. The capillary forces aid agglomerate consolidation by pulling the solid particles together while the viscous and frictional forces resist both consolidation and dilation of the solid particle assembly. The mechanisms involved in the formation and growth of melt agglomerates have been categorized into different stages and will be discussed in the following sections.

## 2.1. Stages of Agglomerate Growth

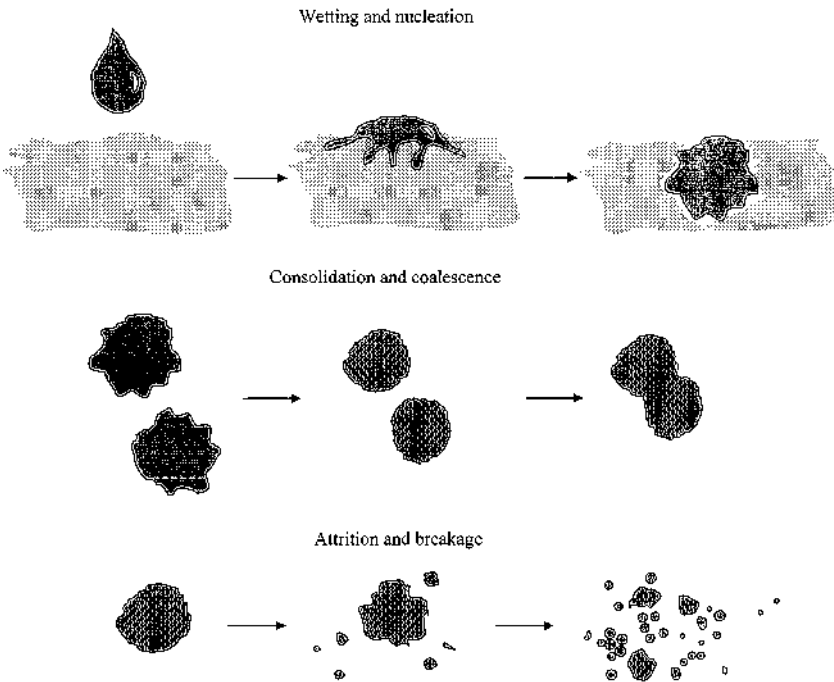
The mechanism of wet agglomeration has traditionally been subdivided into nucleation, coalescence, layering, abrasion transfer, crushing, and other concomitant events such as snow balling and onion skinning, based mainly on the elementary growth mechanism suggested by Sastry and Fuerstenau (Fig. 1) (55). An alternative description of the agglomeration mechanism has also been proposed (2,56). The process of agglomeration consists of a combination of three phases: wetting and nucleation, consolidation and growth, together with the steps of attrition and breakage (Fig. 2).

### 2.1.1. Wetting and Nucleation

Nucleation is the initial phase of agglomeration in which nuclei or small agglomerates of loose and porous structure are formed after the primary particles are wetted by a binding liquid droplet. The primary particles are bound by liquid bridges in the



**Figure 1** Elementary agglomerate growth mechanisms. (Adapted from Ref. 55.)



**Figure 2** A recent approach in describing the agglomeration mechanism. (Adapted from Ref. 2.)

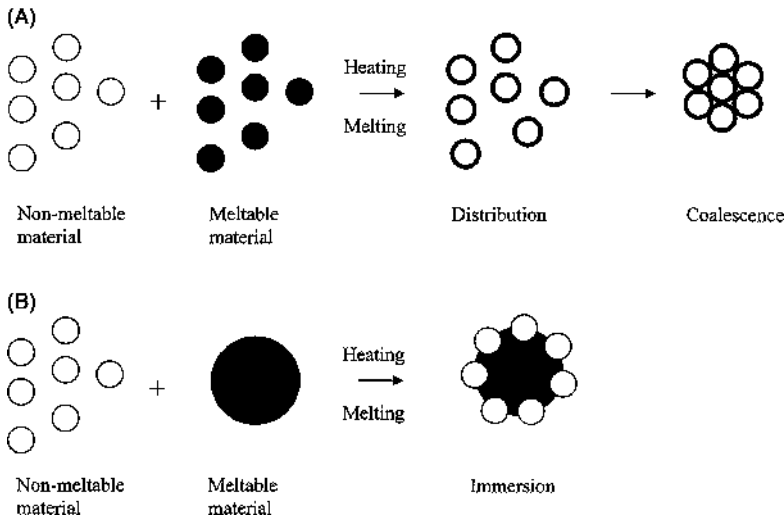
pendular state. The degree of liquid saturation of an agglomerate can be increased either by continuous addition of liquid or through the consolidation of the agglomerate. Two nucleation mechanisms, namely immersion and distribution, are proposed by Schäfer and Mathiesen (50), based on the process of melt agglomeration (Fig. 3). The dominance of either mechanism in the nucleation process of melt agglomeration is a function of the ratio between the sizes of primary particles and molten binder droplets (25,50,52).

Nucleation by immersion occurs when the size of the molten binder droplets is greater than that of the fine solid particles. Immersion proceeds by the deposition of fine solid particles onto the surfaces of molten binder droplets. The propensity of nucleation by immersion method is promoted by large binder droplet size, high binder viscosity, and low shearing forces. High binder viscosity and low shearing forces reduce the opportunity of molten binder droplets to break down, thus keeping their size comparatively large and several times the size of the fine solid particles.

In nucleation by distribution method, a molten binding liquid is distributed onto the surfaces of fine solid particles. The nuclei are formed by the collision between the wetted particles. The formed nuclei have a loose structure with entrapped air unlike those produced by the immersion method. Generally, small binder droplet size, low binder viscosity, and high shearing forces are favorable conditions for nucleation by the distribution method.

The nucleation phase is characterized by the disappearance of fines (35), as a consequence of coalescence between the wetted primary particles or the primary particles with the formed nuclei. The resultant nuclei would undergo consolidation under the impact of the externally applied mechanical forces and acquire sufficient





**Figure 3** Modes of nucleation mechanism: (A) distribution and (B) immersion. (Adapted from Ref. 50.)

strength to resist further breakdown by impact forces and will be able to grow into bigger agglomerates.

### 2.1.2. Consolidation and Growth

Agglomerate growth refers to progression in the size of the formed nuclei, typically by binary coalescence and layering. The number of nuclei is progressively reduced with an increase in size of the resultant agglomerates by coalescence. In contrast, the number of agglomerates remains largely unchanged when size enlargement proceeds by layering. The layering growth stage generally takes place after the agglomerates have attained a certain size and rigidity and is associated with the reduced rate of coalescence (57).

The probability of successful fusion between the collided nuclei is dependent on the liquid saturation state of nuclei. During the process of agglomeration, the agglomerates are consolidated by the agitation forces. The reduction in agglomerate pore size and number promotes the migration of binding liquid from agglomerate core to surfaces, thus enhancing the surface plasticity and propensity of agglomerate growth by coalescence. The rate and extent of consolidation of an agglomerate is governed by interparticulate frictional, capillary, and viscous forces. The interparticulate frictional and viscous forces resist the consolidation process of agglomerates. Conversely, the capillary forces promote the consolidation of agglomerates by pulling the particles together (58). The net extent of consolidation for an agglomerate is dependent on the relative magnitude of these forces, which is a function of agglomerate size, viscosity, and surface tension of binding liquid, as well as the physicochemical properties of fine solid particles (17,20,45,52,59,60).

The degree of liquid saturation of an agglomerate may be increased through consolidating the agglomerates by agitation. Alternatively, it is attainable by adding an additional volume of binding liquid to the existing agglomerates, making the liquid bridges of nuclei progress from pendular to funicular and followed by the capillary state where the level of liquid saturation can be as high as 80–100%. The degree of

liquid saturation reaches and probably exceeds 100% prior to agglomeration when a cohesive powder, highly viscous binding liquid, or an excessive amount of binding liquid is employed. At the droplet state when excessively high liquid saturation is attained, there is considerable risk of agglomerate overwetting and uncontrollable agglomerate growth may result. In contrast to the conventional wet agglomeration processes, the level of liquid saturation of melt agglomerates cannot be reduced via the evaporation of solvent. The effects of excess surface wetness are counteracted by the application of a very high impeller speed which aids in the dispersion of lumps and large agglomerates or through the use of porous fine particles which could accommodate binding liquid in pores and crevices, away from the agglomerate surfaces.

### 2.1.3. Attrition and Breakage

Attrition and breakage refer to the phenomenon of agglomerate fragmentation in the dry and wet states respectively (2). In melt agglomeration, the formed agglomerates are solidified by tray cooling to ambient temperature without the need for drying by a tumbling process. Consequently, breakage is known to have a more essential role in affecting the resultant properties of the melt agglomerates during the agglomerative phase.

The propensity of agglomerate breakage is largely governed by the strength of the agglomerates. Rumpf (61) described the strength of moist agglomerates in their static funicular and capillary states as follows:

$$\sigma_t = SC \frac{1 - \varepsilon \gamma}{\varepsilon d} \cos \theta \quad (2.1)$$

where  $\sigma_t$  is the tensile strength,  $S$  is the liquid saturation,  $C$  is a constant,  $\varepsilon$  is the agglomerate porosity,  $\gamma$  is the surface tension of binding liquid,  $d$  is the surface mean particle diameter, and  $\theta$  is the contact angle between the solid particles and the binding liquid. The strength of moist agglomerates is promoted by an elevation in surface tension of the binding liquid, liquid saturation, and wetting state of solid particles, as well as a reduction in agglomerate porosity and mean size of solid particles.

The application of a binding liquid with low viscosity and surface tension values increases the propensity of agglomerates to breakage (17). This deters the agglomerates from consolidation. The regular breakdown of agglomerates aids in the distribution of binding liquid across the solid particle bed ensuring homogenous agglomerate growth. Nevertheless, it prevents a complete buildup of structure which is needed for size enlargement process. In the case of spheronization, the regular breakdown of agglomerates is translated to the absence of a plastically deformable coalesced structure which is needed for rounding through shaping of agglomerate surfaces by particle rearrangement.

## 3. FACTORS AFFECTING MELT AGGLOMERATION

The formation and growth processes of melt agglomerates are governed by formulation, processing, and equipment variables to a greater extent than those of conventional wet agglomerates as a result of the involvement of high impeller speeds and high shearing forces for agglomeration and viscous molten binding liquid. Many

researchers had studied the influences of these variables, through the characterization of melt agglomerates as previously illustrated, for a better understanding and control of the melt agglomeration processes.

The effects of processing variables such as mixing time, mixing speed, mixer load, jacket temperature, and method of binder addition on melt agglomeration have been extensively investigated (8,11,13,43,52,62–67). Typically, an increase in mixing time or mixing speed promotes agglomerate growth through squeezing the molten binding liquid from agglomerate core to surfaces by means of a densification process, thus increasing the degree of liquid saturation of agglomerates and their propensity to grow by binary coalescence following the collision between two or more plastically deformable surfaces. Under the continuous stirring action of impeller rotation, the deformable surfaces of these agglomerates can be rounded via intra-agglomerate rearrangement of particles leading to the formation of spherical pellets.

The influences of equipment variables on melt agglomerate growth are more marked with high-shear mixers than with low-shear mixers and fluid bed granulators. One main reason is that the intensity of shearing forces is greater in high-shear mixers. The high shearing forces promote a more even distribution of molten binding liquid making the size distribution of melt agglomerates becoming narrower. The level of shearing forces generated in a high-shear mixer is dependent on the geometry of impeller blade, design of processing chamber, and relative dimension between the blade and chamber. The construction of both impeller blade and processing chamber can have a significant impact on the flow pattern of processing material. The use of a truncated cone-shaped lid (11) and an inner wall lining made of polytetrafluoroethylene (68) reduced the adhesion of mass undergoing agglomeration onto the wall of the processing chamber. Variation in the curvature of impeller blade and the distance from its base to the floor of the chamber likewise brought about changes in the flow pattern of the wet mass (12,18). The pattern of material flow is related to the mechanical force distribution and homogeneity of melt agglomeration. It has a strong bearing on the disparity in size and shape of the formed agglomerates.

In the case of formulation variables, the effects of size, size distribution, shape, density, and packing properties of fine solid particles have been reported (10,69,70). The use of solid particles of mean size smaller than  $10\ \mu\text{m}$  is usually problematic in melt agglomeration because a very high level of liquid saturation is needed to overcome the high agglomerate strength resulting from the cohesiveness of small particles in order to provide sufficient agglomerate deformability for growth. This, in turn, can lead to a potentially uncontrollable melt agglomerative process. Generally, solid particles with size ranges between 20 and  $25\ \mu\text{m}$  are preferable for the production of melt agglomerates (10). Excessively large solid particles, with a mean size of over  $100\ \mu\text{m}$ , produce mechanically weak agglomerates or fines. The excessively large or small solid particles will tend to produce irregularly shaped melt agglomerates as such aggregates are susceptible to breakdown under the influence of shear forces or have rigid particle linkages within the agglomerate which inhibit particle deformation and rearrangement. The effects of size, size distribution, shape, density, and packing property of fine solid particles on melt agglomeration are interdependent. Size, size distribution, shape, and density affect the packing geometry of solid particles, bound by molten binding liquid, within the agglomerate. The strength of particulate interlocking, state of liquid distribution, and saturation of agglomerates can be altered via the modification in these properties of fine solid particles.

The effects of binder volume, binder rheology, binder surface property, and binder particle size on melt agglomeration have largely been reported in relation

to the influences of other formulation or processing variables (15,17,20,36,45,70). The growth of melt agglomerates is promoted predominantly by an increase in viscosity, tack, and specific volume as well as a decrease in surface tension of the molten binding liquid. The viscosity, tack, specific volume, and surface tension govern the intra-agglomerate mobility of molten binding liquid and state of liquid saturation of melt agglomerates. The influences of viscosity, tack, and surface tension of molten binding liquid on melt agglomeration are affected by product temperature, mixing speed, and physicochemical properties of the fine solid particles. The effect of binder particle size on melt agglomeration is less marked except when high-viscosity binder is used and at early agglomerative phases (50). At the early agglomerative phase, the dimension of droplets of a very viscous molten binding liquid can remain large and unreduced by the high shearing forces, resulting in larger agglomerates for further growth.

#### **4. CONTROL OF MELT AGGLOMERATION**

The growth processes of melt agglomerates are sensitive to formulation, processing, and equipment variables. A better understanding of the mechanism of melt agglomerate formation aids in the development of methods to control and monitor the in-process changes of product attributes. In conventional wet agglomeration process, the instrumentation of equipment to monitor and control the operation has been studied by several investigators. The incorporation of sensors and suitable instrumentation of the equipment enables changes in agglomerate properties during the agglomeration process to be monitored such that the end point of the process can be accurately predicted.

##### **4.1. Image Processing/Infrared Spectroscopy/Bed Height**

In fluid bed agglomeration process, the control of agglomerate growth through monitoring agglomerate moisture content using infrared spectroscopy (71–73) or agglomerate size and shape using an image processing system (74,75) has been investigated. The application of bed height control to monitor agglomerate growth in fluid bed agglomeration process has also been studied (76,77). Of all instrumentation techniques, the image processing system can potentially be adopted as a tool to control the melt agglomeration process. Such a system requires a heat-resistant optic device capable of withstanding the processing temperatures associated with the melt agglomeration process of up to as high as 120°C. The infrared spectroscopy or equivalent techniques are less suitable for use in monitoring the melt agglomerate growth process. Unlike the wet agglomeration process, the meltable binder is incorporated with the processing material prior to mixing and shearing in the melt processor to bring the binder to its melting temperature. Practically, there is no need for monitoring the changes of binding liquid content added. Melt agglomeration in high-shear mixer proceeds by the active centrifugal massing of the processing materials. In contrast to the fluid bed agglomerator, the bed height of powder particles in the processing chamber is less affected by gravitational forces and the upward air flow velocity required for particle suspension. For a given material load, the bed height is expected to have minimal effects on the changes in product attributes. It is envisaged that the measurement of bed height would not be useful in reflecting the in-process product attributes.

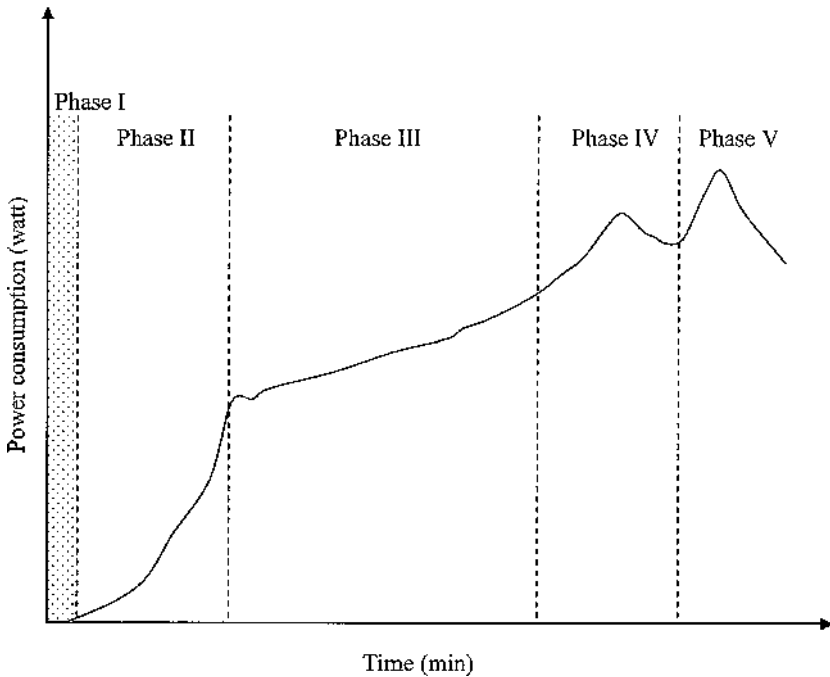
## 4.2. Torque/Current/Power Consumption

For wet agglomeration in high- or low-shear mixers, the popular method for instrumentation involves an indirect measurement based on the changes in rheological properties of moistened mass which are related to the growth propensity of agglomerates. The process of extrusion in extrusion–spheronization had been monitored using the measurement of power consumption of the extruder motor or extrusion force on the screen (78–84). Low-shear mixers had employed torque (85–90), power consumption (85,91–93), or current (94) measurements as the tool for end-point determination. The instrumentation technique for high-shear mixers involved the measurement of torque on impeller shaft (95,96), power consumption (80,95–110), current (111,112) or motor slip (113–116). Technically, power and current consumption are the simpler techniques for monitoring the agglomerate growth in a high-shear mixer. It was easier to equip a high-shear mixer with a power consumption meter than a sensor for torque or slip measurement (117). Torque generated had been reported to provide a more descriptive profile of the agglomeration process than power consumption. Nevertheless, there were only small differences between the two methods for process monitoring (95,96,117). The measurement of torque is a more expensive method and technically more difficult due to problems associated with the transmission of signals from the sensor (118). Holm et al. (98) showed that the power consumption profile of an agglomeration process was related to plasticity and liquid saturation of the processing material in addition to that of the interparticulate friction within the agglomerates. Since plastic deformation is important for agglomerate growth, power consumption may then be related to the agglomeration propensity.

A slow and continuous binding liquid addition is a prerequisite for obtaining a power consumption that is suitable for use in process control of wet agglomeration (118). Five characteristic phases of power consumption are identifiable (Fig. 4). In the first phase, a wetting of powder mixture takes place without any observable rise in the power consumption.

The subsequent addition of binding liquid brings about particle agglomeration and a sharp rise in the magnitude of power consumption. The power consumption of the agglomeration process levels off as the agglomerates gradually become dense and saturated with the binding liquid. During the fourth phase, the power consumption rises due to overwetting and excessive growth of agglomerates by coalescence. The power consumption falls in the fifth phase and it is associated with the formation of a suspension upon the addition of an excessive amount of the binding liquid. The optimum end point of the process lies within the third phase of the power consumption tracing. In the case of melt agglomeration process, the addition of meltable binder is almost instantaneous. This lack of the typical power consumption profile makes power consumption measurement less suitable for monitoring melt agglomeration end point as in the case of the wet agglomeration process. In laboratory high-shear mixers, an increase in melt agglomerate size is not reflected in the power consumption signals except at an excessively high impeller speed (11,69). The deformability of the agglomerates produced by a molten binding liquid is relatively low in comparison to that of agglomerates formed when using an aqueous binding liquid. The sensitivity of power consumption measurement is not sufficiently discriminating to reflect small changes in the plasticity of melt agglomerates.

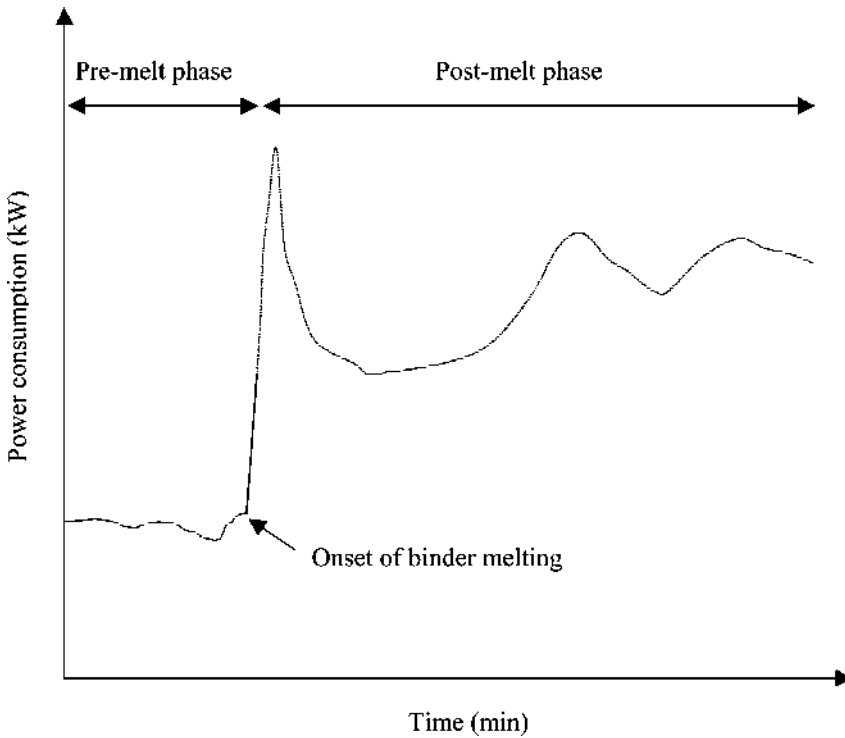
During the premelt agglomeration phase of the powder mixture, the level of power consumption is low and with minimal fluctuations in its magnitude (Fig. 5).



**Figure 4** Power consumption profile of a wet agglomeration process. (Adapted from Ref. 118.)

The magnitude of the power consumption falls to a value slightly below that of the values obtained during the premelt agglomeration phase when the binder particles begin to melt upon the influence of frictional heat generated by the impeller rotation (9). Such observation could be related to the lubricating effect of molten binding liquid on the solid particles undergoing agglomeration. The power consumption rises sharply following the complete melting of the binder particles. The molten binding liquid is distributed rapidly throughout the powder mixture. The level of power consumption becomes lower upon the complete distribution of the molten binding liquid and increases as the agglomerate growth takes place.

Generally, a higher level of power consumption is recorded when a higher impeller speed or a more viscous molten binding liquid is employed for the preparation of melt agglomerates. The rise in power consumption is delayed when a viscous melttable binder is used (119). The growth process of melt agglomerates is not easily interpretable from the record of power consumption when the growth propensity of melt agglomerates is strongly governed by the viscosity of the molten binding liquid. This is ascribed to greater difficulties in distributing viscous molten binding liquid and a slower rate of agglomerate densification. A viscous binder hinders the consolidation of agglomerates as a viscous liquid resists plastic deformation and its migration from core to the surface of the agglomerate during consolidation. The power consumption measurements are not directly comparable between high-shear mixers of different processing capacities. However, the values of power consumption can be correlated to the changes in size of the agglomerates produced using a large-scale high-shear mixer, albeit such relationship is not attainable when using a laboratory scale high-shear mixer (12).



**Figure 5** Profile of power consumption at premelt and postmelt phases. (Adapted from Ref. 19.)

### 4.3. Energy Consumption

The applicability of both processing power and energy consumption as tools to monitor agglomerate growth in a melt agglomeration process has been studied (19,65). Postmelt specific power consumption, postmelt specific energy consumption, and average postmelt specific power consumption were computed. The postmelt specific power consumption was calculated by dividing the postmelt power consumption read at specific postmelt processing time, with the total weight of processing material. The postmelt specific energy consumption was obtained by integrating the area of postmelt specific power consumption against postmelt processing time curve. The average postmelt specific power consumption was represented by the quotient of postmelt specific energy consumption to that of the corresponding length of postmelt processing time.

#### 4.3.1. Melt Agglomerate Size

The increase in the melt agglomerate size was more closely correlated to the postmelt specific energy consumption than that of the average postmelt specific power consumption or postmelt specific power consumption. This is because specific energy consumption can be considered as the amount of work done for the formative process of consolidating the primary particles into melt agglomerates. It is more indicative of the stage of melt agglomerate growth. The postmelt specific energy consumption and postmelt processing time were linearly correlated and the formation of larger melt agglomerates at longer processing time involved a greater level

of energy consumption. The postmelt specific energy consumption and melt agglomerate size were linearly related and such a relationship was not dependent on the effect of impeller speed except that of the binder concentration and size of solid particles. In relating the influences of binder concentration and size of solid particles on the outcome of agglomeration with respect to postmelt specific energy consumption, an equation was established. The processes of melt agglomerate formation and growth were described using a modified macroscopic population model. The model of melt agglomeration, under the specified processing conditions, was summarized as:

$$d = f_1(s)[1 + f_2(c)E_{\text{melt}}] \quad (4.1)$$

where  $d$  refers to mean melt agglomerate size,  $E_{\text{melt}}$  is the postmelt specific energy consumption,  $f_1(s)$  and  $f_2(c)$  represent polynomial relationships with size of solid particles and binder concentration as independent variables, respectively. Using Eq. 4.1, the theoretical value of melt agglomerate size was found in good agreement with the experimental data obtained from melt agglomeration runs employing various binder concentrations and different sizes of primary particles. Nonetheless, it should be emphasized that the application of postmelt specific energy consumption for the control of melt agglomeration process would be inappropriate in processes encountering an excessive level of material adhesion or when large amounts of lumps are formed. The effective weight of processing material is markedly reduced in the presence of an excessive level of material adhesion. This will give rise to inaccuracies in computing the postmelt specific energy consumption level. With the excessive formation of lumps, the rope-like flow pattern of the agglomerates will be affected. The movement of agglomerates, bound within the processing chamber, is expected to be variable. As a result, the predictability of the melt agglomeration process using postmelt specific energy consumption will be substantially reduced by the changes in product attributes from one batch to another. Practically, Eq. 4.1 is useful for predicting the end point of an optimal or near-optimal melt agglomeration run.

Frequently, the end point of an agglomeration process is governed by the size of the formed agglomerates. The geometric-weight mean diameter of melt agglomerates is calculated using Eq. 1.1 described by Schäfer and Worts (48). In the case of melt agglomerates with size distribution which cannot be fitted into a log-normal relationship, the mass median diameter of agglomerates shall be adopted for representing of the size of melt agglomerates produced.

#### 4.3.2. Melt Agglomerate Shape

The shape and tensile strength of melt agglomerates may be used to characterize the agglomeration process besides the more generally used size of melt agglomerates. Similar to the measurement of size, both shape and tensile strength can be determined using quick, simple, and accurate methods. The sphericity of melt agglomerates is best evaluated using the image analysis system. The image analyzer consists of a computer system connected to a video camera mounted on a stereomicroscope. The average projected area and perimeter of melt agglomerates are determined from the digitized images of agglomerates. By transformation of these basic parameters, melt agglomerate sphericity is calculated. The sphericity value gives a measure of melt agglomerate roundness. A sphericity value, determined by Eq. 4.2, of unity



describes a perfect circle. The agglomerate sphericity is defined as:

$$\text{Sphericity} = \frac{4\pi \times \text{Area}}{(\text{Perimeter})^2} \quad (4.2)$$

The melt agglomeration process can be divided into two spheronization phases, a fast initial rate followed by a slow rate (65). The change in spheronization rate was associated with that of agglomerate size, porosity, and flow pattern of the processing material. The study established a biexponential mathematical model to relate the agglomerate sphericity with postmelt specific energy consumption. The relationship of agglomerate sphericity with postmelt specific energy consumption was found to be independent of the effect of various production variables, such as postmelt impeller speed, binder concentration, and size of solid particles. The biexponential mathematical model has an equation as follows:

$$1 - \text{Sphericity} = [0.4107 \exp(-0.0118E_{\text{melt}})] + [0.0533 \exp(-0.0004E_{\text{melt}})] \quad (4.3)$$

Overall, the characterization of the melt agglomeration end point using the biexponential mathematical model is simple and without the need to consider the physicochemical properties of the processing materials used. As the process of agglomeration is aimed at making highly spherical pellets, predictive methods based on sphericity will help to capture the ideal end point together with predictive methods based on size.

#### 4.3.3. *Melt Agglomerate Tensile Strength*

The formative process of melt agglomerates is accompanied by changes in the size, shape, and porosity of melt agglomerates (19,65,120). The formation of a less porous melt agglomerate is related to an increase in the size and level of sphericity of the product. This is attributed to an enhanced molten binding liquid migration from core to surfaces of agglomerates upon densification, which promotes rounding and binary growth of melt agglomerates as previously described. The application of agglomerate porosity as an in-process control parameter is not practical as such a measurement requires a long experimental time and the accuracy of such a measurement is subjected to the skill of an operator. The tensile strength is an indirect measurement of the porosity of melt agglomerates. It has an inverse relationship with the porosity of melt agglomerates. The tensile strength of melt agglomerates can be determined using a tensile tester. The crushing force is usually applied at a fixed rate. The load required to crush each melt agglomerate is recorded. The evaluation of tensile strength of melt agglomerates is relatively simple and it is useful as an in-process control parameter for melt agglomeration processes.

## 5. CONCLUSIONS

Over the past decade, the properties of processing materials and their effects on melt agglomeration have been extensively investigated. Principally, solid particle size, size distribution, shape, density, packing property, as well as solid binder particle size, molten binding liquid viscosity, molten binding liquid surface tension, and molten binding liquid tack have their individual influences on the size, shape, and porosity of melt agglomerates produced. In the case of equipment and processing variables,

off-bottom clearance, impeller geometry, construction characteristics of the processing chamber, nature of wall lining, impeller speed, jacket temperature, mixing time, and mixer load are important variables affecting the kinetics of melt agglomeration and characteristics of the formed agglomerates. The reproducibility in control of a melt agglomeration process is strongly dependent on the rigid surveillance of all critical formulation, processing, and equipment variables. Apart from the tight control of formulation, processing, and equipment parameters, the application of in-process monitoring tool and predictive mathematical model are imperative to avoid any uncontrollable melt agglomeration.

## REFERENCES

1. Tardos GI, Khan MI, Mort PR. Critical parameter and limiting conditions in binder granulation of fine powders. *Powder Technol* 1997; 94:245–258.
2. Iveson SM, Litster JD, Hapgood K, Ennis BJ. Nucleation, growth and breakage phenomena in agitated wet granulation processes: a review. *Powder Technol* 2001; 117: 3–39.
3. Ghebre-Sellassie I. Mechanism of pellet formation. Ghebre-Sellassie I, ed. *Pharmaceutical Pelletization Technology*. Vol. 37. New York: Marcel Dekker, Inc., 1989:129.
4. Rubinstein MH. A new granulation method for compressed tablet. *J Pharm Pharmacol* 1976; 28:67.
5. Rubinstein MH, Musikabhuma P. Formulation and evaluation of paracetamol 500 mg tablets produced by a new direct granulation method. *Drug Dev Ind Pharm* 1980; 6(5):451–473.
6. McTaggart CM, Ganley JA, Sickmueller A, Walker SE. The evaluation of formulation and processing conditions of a melt granulation process. *Int J Pharm* 1984; 19:139–148.
7. Schæfer T, Holm P, Kristensen HG. Melt granulation in a laboratory scale high shear mixer. *Drug Dev Ind Pharm* 1990; 16(8):1249–1277.
8. Schæfer T, Holm P, Kristensen HG. Melt pelletization in a high shear mixer. I. Effects of process variables and binder. *Acta Pharm Nordica* 1992; 4:133–140.
9. Schæfer T, Holm P, Kristensen HG. Melt pelletization in a high shear mixer. II. Power consumption and granule growth. *Acta Pharm Nordica* 1992; 4:141–148.
10. Schæfer T, Holm P, Kristensen HG. Melt pelletization in a high shear mixer. III. Effects of lactose quality. *Acta Pharm Nordica* 1992; 4:245–252.
11. Schæfer T, Taagegaard B, Thomsen LJ, Kristensen HG. Melt pelletization in a high shear mixer. IV. Effects of process variables in a laboratory scale mixer. *Eur J Pharm Sci* 1993; 1(3):125–131.
12. Schæfer T, Taagegaard B, Thomsen LJ, Kristensen HG. Melt pelletization in a high shear mixer. V. Effects of apparatus variables. *Eur J Pharm Sci* 1993; 1(3): 133–141.
13. Thomsen LJ, Schæfer T, Sonnergaard JM, Kristensen HG. Prolonged release matrix pellets prepared by melt pelletization. Part 1. Process variables. *Drug Dev Ind Pharm* 1993; 19(15):1867–1887.
14. Thomsen LJ, Schæfer T, Kristensen HG. Prolonged release matrix pellets prepared by melt pelletization. Part 2. Hydrophobic substances as meltable binders. *Drug Dev Ind Pharm* 1994; 20(7):1179–1197.
15. Eliassen H, Schæfer T, Kristensen HG. Effects of binder rheology on melt agglomeration in a high shear mixer. *Int J Pharm* 1998; 176:73–83.
16. Eliassen H, Kristensen HG, Schæfer T. Electrostatic during a melt agglomeration process. *Int J Pharm* 1999; 184:85–96.
17. Eliassen H, Kristensen HG, Schæfer T. Growth mechanisms in melt agglomeration with a low viscosity binder. *Int J Pharm* 1999; 186:149–159.

18. Heng PWS, Wan LSC, Wong TW. Effect of off-bottom clearance on properties of pellets produced by melt pelletization. *Pharm Dev Technol* 1999; 4(1):27–33.
19. Heng PWS, Wong TW, Shu JJ, Wan LSC. A new method for the control of size of pellets in the melt pelletization process with a high shear mixer. *Chem Pharm Bull* 1999; 47:633–638.
20. Wong TW, Wan LSC, Heng PWS. Effects of physical properties of PEG 6000 on pellets produced by melt pelletization. *Pharm Dev Technol* 1999; 4(3):449–456.
21. Maejima T, Osawa T, Kobayashi M, Noda K. Factors effecting spherical granulation of drugs by tumbling granulation method. *Chem Pharm Bull* 1992; 40(2):488–492.
22. Maejima T, Osawa T, Nakajima K, Kobayashi M. Preparation of spherical beads without any use of solvents by a novel tumbling melt granulation (TMG) method. *Chem Pharm Bull* 1997; 45:518–524.
23. Maejima T, Osawa T, Nakajima K, Kobayashi M. Effects of species of non-meltable and meltable materials and their physical properties on granulatability in tumbling melt granulation method. *Chem Pharm Bull* 1997; 45:1833–1839.
24. Maejima T, Kubo M, Osawa T, Nakajima K, Kobayashi M. Application of tumbling melt granulation (TMG) method to prepare controlled-release fine granules. 1998; 46:534–536.
25. Abberger T, Seo A, Schæfer T. The effect of droplet size and powder particle size on the mechanisms of nucleation and growth in fluid bed melt agglomeration. *Int J Pharm* 2002; 249:185–197.
26. Kidokoro M, Haramiishi Y, Sagasaki S, Shimizu T, Yamamoto Y. Application of fluidized hot-melt granulation (FHMg) for the preparation of granules for tableting; properties of granules and tablets prepared by FHMg. *Drug Dev Ind Pharm* 2002; 28(1):67–76.
27. Seo A, Holm P, Schæfer T. Effects of droplet size and type of binder on the agglomerate growth mechanisms by melt agglomeration in a fluidized bed. *Eur J Pharm Sci* 2002; 16(3):95–105.
28. Pataki K, Horváth E, Ormós Z. Rolling bed granulation with local melt forming. Proceedings of 4th Conference on Applied Chemistry, Unit Operations and Processes, Vol. 3. Veszprem, Hungary. 1983:361–362.
29. Litster JD, Sarwono R. Fundamental studies of fluidized drum granulation. Proceedings of the 1st International Particle Technology Forum, Denver, CO, Part 1, Aug 17–19, 1994; 265–270.
30. Edimo A, Leterme P, Denis J, Traisnel M, Gayot AT. Capacity of lipophilic auxiliary substances to give spheres by extrusion-spheronization. *Drug Dev Ind Pharm* 1993; 19(7):827–842.
31. Miyagawa Y, Okabe T, Yamaguchi Y, Miyajima M, Sato H, Sunada H. Controlled-release of diclofenac sodium granule. *Int J Pharm* 1996; 138:215–224.
32. Zhang F, McGinity JW. Properties of sustained release tablets prepared by hot-melt extrusion. *Pharm Dev Technol* 1999; 4:241–250.
33. Liu J, Zhang F, KcGinity J. Properties of lipophilic matrix tablets containing phenylpropanolamine hydrochloride prepared by hot-melt extrusion. *Eur J Pharm Biopharm* 2001; 52:181–190.
34. Young CR, Koleng JJ, McGinity JW. Production of spherical pellets by a hot-melt extrusion and spheronization process. *Int J Pharm* 2002; 242:87–92.
35. Schæfer T. Growth mechanisms in melt agglomeration in high shear mixers. *Powder Technol* 2001; 117:68–82.
36. Evrard B, Amighi K, Beten D, Delattre L, Moës AJ. Influence of melting and rheological properties of fatty binders on the melt granulation process in a high-shear mixer. *Drug Dev Ind Pharm* 1999; 25(11):1177–1184.
37. Evrard B, Delattre L. In vitro evaluation of lipid matrices for the development of a sustained-release sulfamethazine bolus for lambs. *Drug Dev Ind Pharm* 1996; 22(2):111–118.

38. Zhou F, Vervaet C, Remon JP. Matrix pellets based on the combination of waxes, starches and maltodextrins. *Int J Pharm* 1996; 133:155–160.
39. Voinovich D, Moneghini M, Perissutti B, Filipovic-Grcic J, Grabnar I. Preparation in high-shear mixer of sustained-release pellets by melt pelletisation. *Int J Pharm* 2000; 203:235–244.
40. Passerini N, Albertini B, González-Rodríguez ML, Cavallari C, Rodriguez L. Preparation and characterization of ibuprofen-poloxamer 188 granules obtained by melt granulation. *Eur J Pharm Sci* 2002; 15:71–78.
41. Hamdani J, Moes AJ, Amighi K. Development and evaluation of prolonged release pellets obtained by the melt pelletization process. *Int J Pharm* 2002; 245:161–177.
42. Perissutti B, Rubessa F, Moneghini M, Voinovich D. Formulation design of carbamazepine fast-release tablets prepared by melt granulation technique. *Int J Pharm* 2003; 256:53–63.
43. Thies R, Kleinebudde P. Melt pelletisation of a hygroscopic drug in a high shear mixer. Part 1. Influence of process variables. *Int J Pharm* 1999; 188:131–143.
44. Yanze FM, Duru C, Jacob M. A process to produce effervescent tablets: fluidized bed dryer melt granulation. *Drug Dev Ind Pharm* 2000; 26(11):1167–1176.
45. Heng PWS, Wong TW, Cheong WS. Investigation of melt agglomeration process with a hydrophobic binder in combination with sucrose stearate. *Eur J Pharm Sci* 2003; 19:381–393.
46. Ukita K, Murakami T. Preparation of essential oils loaded granule by melt granulation. *Drug Dev Ind Pharm* 1994; 20(6):981–992.
47. Appelgren C, Eskilson C. A novel method for the granulation and coating of pharmacologically active substances. *Drug Dev Ind Pharm* 1990; 16(15):2345–2351.
48. Schæfer T, Wörts O. Control of fluidized bed granulation: I: effects of spray angle, nozzle height and starting materials on granule size and size distribution. *Arch Pharm Chem Sci Ed* 1977; 5:51–60.
49. Crowley KJ, Forbes RT, York P, Nyqvist H, Camber O. Drug-fatty acid salt with wax-like properties employed as binder in melt granulation. *Int J Pharm* 2000; 211:9–17.
50. Schaafer T, Mathiesen C. Melt pelletization in a high shear mixer. IX. Effects of binder particle size. *Int J Pharm* 1996; 139:139–148.
51. Johansen A, Schæfer T. Effects of physical properties of powder particles on binder liquid requirement and agglomerate growth mechanisms in a high shear mixer. *Eur J Pharm Sci* 2001; 14:135–147.
52. Scott AC, Hounslow MJ, Instone T. Direct evidence of heterogeneity during high-shear granulation. *Powder Technol* 2000; 113:205–213.
53. El-Shanawany S. Sustained release of nitrofurantoin from inert wax matrices. *J Control Release* 1993; 26:11–19.
54. Brabander CD, Vervaet C, Remon JP. Development and evaluation of sustained release mini-matrices prepared via hot melt extrusion. *J Control Release* 2003; 89:235–247.
55. Sastry KVS, Fuerstenau DW. Mechanisms of agglomerate growth in green pelletization. *Powder Technol* 1973; 7:97–105.
56. Ennis BJ, Litster JD. Particle size enlargement. Perry R, Green D, eds. *Perry's chemical Engineers' Handbook*. 7th ed. Chapter 20. New York: McGraw-Hill, 1997:56–73.
57. Ennis BJ, Tardos G, Pfeffer R. A microlevel-based characterization of granulation phenomena. *Powder Technol* 1991; 65:257–272.
58. Iveson SM, Litster JD. Fundamental studies of granule consolidation. Part 2: Quantifying the effects of particle and binder properties. *Powder Technol*. 1998; 99:243–250.
59. Iveson SM, Litster JD, Ennis BJ. Fundamental studies of granule consolidation. Part 1: effects of binder content and binder viscosity. *Powder Technol* 1996; 88:15–20.
60. Thies R, Kleinebudde P. Melt pelletization of a hygroscopic drug in a high shear mixer. Part 3. Effects of binder variation. *Chem Pharm Bull* 2001; 49(2):140–146.
61. Rumpf H. The strength of granules and agglomerates. In: Knepper WA, ed. *Agglomeration*. New York: Wiley-Interscience, 1962:379–419.

62. Knight PC. An investigation of the kinetics of granulation using a high shear mixer. *Powder Technol* 1993; 77:159–169.
63. Knight PC, Instone T, Pearson JMK, Hounslow MJ. An investigation into the kinetics of liquid distribution and growth in high shear mixer agglomeration. *Powder Technol* 1998; 97:246–257.
64. Knight PC, Johansen A, Kristensen HG, Schaefer T, Seville JPK. An investigation of the effects on agglomeration of changing the speed of a mechanical mixer. *Powder Technol* 2000; 110:204–209.
65. Heng PWS, Wong TW, Chan LW. Influence of production variables on the sphericity of melt pellets. *Chem Pharm Bull* 2000; 48(3):420–424.
66. Heng PWS, Chan LW, Zhu L. Effects of process variables and their interactions on melt pelletization in a high shear mixer. *STP Pharm Sci* 2000; 10(2):165–172.
67. Voinovich D, Moneghini M, Perissutti B, Franceschini E. Melt pelletization in high shear mixer using a hydrophobic melt binder: influence of some apparatus and process variables. *Eur J Pharm Biopharm* 2001; 52(3):305–313.
68. Zhou F, Vervaeet C, Rernon JP. Influence of processing on the characteristics of matrix pellets based on microcrystalline waxes and starch derivatives. *Int J Pharm* 1997; 147(1):23–30.
69. Schaefer T. Melt pelletization in a high shear mixer. X. Agglomeration of binary mixtures. *Int J Pharm* 1996; 139:149–159.
70. Johansen A, Schaefer T. Effects of interactions between powder particle size and binder viscosity on agglomerate growth mechanisms in a high shear mixer. *Eur J Pharm Sci* 2001; 72:297–309.
71. Watano S, Terashita K, Miyanami K. Determination of end-point with a complex granulation applying infrared moisture sensor. *Chem Pharm Bull* 1991; 39(4):1013–1017.
72. Watano S, Yamamoto A, Miyanami K. Effects of operational variables on the properties of granules prepared by moisture control method in tumbling fluidized bed granulation. *Chem Pharm Bull* 1994; 42(1):133–137.
73. Frake P, Greenhalgh D, Grierson SM, Hempenstall JM, Rudd DR. Process control and end point determination of a fluid bed granulation by application of near infrared spectroscopy. *Int J Pharm* 1997; 151(1):75–80.
74. Watano S, Miyanami K. Image processing for on-line monitoring of granule size distribution and shape in fluidized bed granulation. *Powder Technol*. 1995; 83(1):55–60.
75. Watano S, Sato Y, Miyanami K. Control of granule growth in fluidized bed granulation by an image processing system. *Chem Pharm Bull* 1996; 44(8):1556–1560.
76. Watano S, Fukushima T, Miyanami K, Murakami T, Sato T. Automation of the manufacturing process of cold remedy granules by a tumbling fluidized bed applying the fuzzy control method. *Chem Pharm Bull* 1994; 42(6):1302–1307.
77. Watano S, Fukushima T, Miyanami K. Application of fuzzy logic to bed height control in agitation-fluidized bed granulation. *Powder Technol* 1994; 81(2):161–168.
78. Baert L, Fanara D, Baets PD, Remon JP. Instrumentation of a gravity feed extruder and the influence of the composition of binary and ternary mixtures on the extrusion forces. *J Pharm Pharmacol* 1991; 43(11):745–749.
79. Baert L, Fanara D, Remon JP, Massart D. Correlation of extrusion forces, raw materials and sphere characteristics. *J Pharm Pharmacol* 1992; 44(8):676–678.
80. Elbers JAC, Bakkenes HW, Fokkens JG. Effect of amount and composition of granulation liquid on mixing, extrusion and spherization. *Drug Dev Ind Pharm* 1992; 18(5):501–517.
81. Baert L, Down GRB. A comparison of two methods of instrumenting a small-scale basket extruder. *Int J Pharm* 1994; 107(3):219–222.
82. Kleinebudde P, Sølvberg AJ, Lindner H. The power consumption-controlled extruder: a tool for pellet production. *J Pharm Pharmacol* 1994; 46(7):542–546.
83. Vervaeet C, Baert L, Risha PA, Remon JP. The influence of the extrusion screen on pellet quality using an instrumented basket extruder. *Int J Pharm* 1994; 107(1):29–39.

84. Kleinebudde P. Use of power consumption-controlled extruder in the development of pellet formulations. *J Pharm Sci* 1995; 84(10):1259–1264.
85. Lindberg N-O, Leander L, Wenngren L, Helgesen H, Reenstierna B. Studies on granulation in a change can mixer. *Acta Pharm Suecica* 1974; 11:603–620.
86. Travers DN, Rogerson AC, Jones TM. A torque arm mixer for studying wet massing. *J Pharm Pharmacol* 1975; 27(suppl):3.
87. Lindberg N-O. Studies on granulation in a small planetary mixer. II. Granulation of lactose and an antacid mixture. *Acta Pharm Suecica* 1977; 14:197–204.
88. Lindberg N-O, Leander L, Nilsson PG, Reenstierna B. Studies on granulation in a small planetary mixer. I. Instrumentation *Acta Pharm Suecica* 1977; 14:191–196.
89. Ghanta SR, Srinivas R, Rhodes CT. Use of mixer torque measurements as an aid to optimizing wet granulation process. *Drug Dev Ind Pharm* 1984; 10:305–311.
90. Tapper G.L, Lindberg N-O. The granulation of some lactose qualities with different particle size distributions in a domestic-type mixer. *Acta Pharm Suecica* 1986; 23:47–56.
91. Bier HP, Leuenberger H, Sucker HB. Determination of the uncritical quantity of granulating liquid by power measurements of planetary mixers. *Pharm Ind* 1979; 41:375–380.
92. Leuenberger H. Granulation, new techniques. *Pharm Acta Helv* 1982; 57:72–82.
93. Paris L, Stamm A. Optimal massing liquid volume determination by energy consumption measurement: study of the influence of some physical properties of solvents and products used. *Drug Dev Ind Pharm* 1985; 11(2,3):361–385.
94. Chirkot T, Propst CW. Low shear granulators. Parikh DM, ed. *Handbook of Pharmaceutical Granulation Technology*. New York: Marcel Dekker, Inc., 1997: 205–255.
95. Corvari V, Fry WC, Seibert WL, Augsberger L. Instrumentation of a high shear mixer: evaluation and comparison of a new capacitance sensor, a watt meter, and a strain-gage torque sensor for wet granulation monitoring. *Pharm Res* 1992; 9(12):1525–1533.
96. Kopcha M, Roland E, Bubb G, Vadino WA. Monitoring the granulation process in a high shear mixer/granulator: An evaluation of three approaches to instrumentation. *Drug Dev Ind Pharm* 1992; 18(18):1945–1968.
97. Leuenberger H. Monitoring granulation. *Manuf Chem* 1984; 55:67,69,71.
98. Holm P, Schäfer T, Kristensen HG. Granulation in high-speed mixers. Part V. Power consumption and temperature changes during granulation. *Powder Technol* 1985; 43:213–223.
99. Holm P, Schäfer T, Kristensen HG. Granulation in high-speed mixers. Part VI. Effects of process conditions on power consumption and granule growth. *Powder Technol* 1985; 43:225–233.
100. Ritala M, Jungersen O, Holm P, Schäfer T, Kristensen HG. A comparison between binders in the wet phase of granulation in a high shear mixer. *Drug Dev Ind Pharm* 1986; 12:1685–1700.
101. Terashita K, Oh'ike A, Kato M, Miyayami K. Granulation process and end-point in high speed mixer granulator. *J Pharm Soc Jpn* 1987; 107:377–383.
102. Ritala M, Holm P, Schäfer T, Kristensen HG. Influence of liquid bonding strength on power consumption during granulation in a high shear mixer. *Drug Dev Ind Pharm* 1988; 14:1041–1060.
103. Werani J. Production experience with end point control. *Acta Pharm Suecica* 1988; 25:247–266.
104. Leuenberger H, Usteri M, Imanidis G, Winzap S. Monitoring the granulation process: granulate growth, fractal dimensionality and percolation threshold. *Boll Chim Pharm* 1989; 128:54–61.
105. Watano S, Terashita K, Miyayami K. Frequency analysis of power consumption in agitation granulation of powder materials with sparingly soluble acetaminophen. *Chem Pharm Bull* 1992; 40(1):269–271.

106. Shiraishi T, Kondo S, Yuasa H, Kanaya Y. Studies on the granulation process of granules for tableting with a high speed mixer. I. Physical properties of granules for tableting. *Chem Pharm Bull* 1994; 42(4):932–936.
107. Vertommen J, Michoel A, Rombaut P, Kinget R. Production of pseudoephedrine HCl pellets in a high shear mixer-granulators. *Eur J Pharm Biopharm* 1994; 40(1):32–35.
108. Shiraishi T, Sano A, Kondo S, Yuasa H, Kanaya Y. Studies on the granulation process of granules for tableting with a high speed mixer. II. Influence of particle size of active substance on granulation. *Chem Pharm Bull* 1995; 43(4):654–659.
109. Landin M, York P, Cliff MJ, Rowe RC, Wigmore AJ. The effect of batch size on scale-up of a pharmaceutical granulation in a fixed bowl mixer granulator. *Int J Pharm* 1996; 134:243–246.
110. Laicher A, Profitlich T, Schwitzer K, Ahlert D. Modified signal analysis system for end point control during granulation. *Eur J Pharm Sci* 1997; 5(1):7–14.
111. D'Alonzo GD, O'Connor RE, Schwartz JB. Effect of binder concentration and method of addition on granule growth in a high intensity mixer. *Drug Dev Ind Pharm* 1990; 16(12):1931–1944.
112. Lin K, Peck GE. Development of agglomerated talc. II. Optimization of the processing parameters for the preparation of granulated talc. *Drug Dev Ind Pharm* 1995; 21(2):159–173.
113. Lindberg N-O, Jönsson C. Granulation of lactose in a recording high speed mixer, Diosna P25. *Drug Dev Ind Pharm* 1983; 9(6):959–970.
114. Timko RJ, Johnson JL, Skinner GW, Chen ST, Rosenberg HA. Instrumentation of a vertical high shear mixer with a motor slip monitoring device. *Drug Dev Ind Pharm* 1986; 12(10):1375–1393.
115. Cliff MJ. Granulation end point and automated process control of mixer-granulators: part I. *Pharm Technol* 1990; 14(4):112–132.
116. Cliff MJ. Granulation end point and automated process control of mixer-granulators: part II. *Pharm Technol Int* 1990; 18:20–23.
117. Kristensen HG, Schæfer T. Granulations. In: Swarbrick J, Boylan JC, eds. *Encyclopedia of Pharmaceutical Technology*. Vol. 7. New York: Marcel Dekker, Inc., 1993: 121–160.
118. Holm P. High shear mixer granulators. Parikh DM, ed. *Handbook of Pharmaceutical Granulation Technology*. New York: Marcel Dekker, Inc., 1997:151–204.
119. Schæfer T, Mathiesen C. Melt pelletization in a high shear mixer. VIII. Effects of binder viscosity. *Int J Pharm* 1996; 139:125–138.
120. Wong TW, Chan LW, Heng PWS. Study of the melt pelletization process focusing on the micromeritic property of pellets. *Chem Pharm Bull* 2000; 48(11):1639–1643.

# 14

## Rapid Release Granulation

**P. W. S. Heng**

*National University of Singapore, Singapore*

**Anthony Yolande and Lee Chin Chiat**

*International Specialty Products (ISP) Asia Pacific Pte. Ltd., Singapore*

### 1. INTRODUCTION

Many potential drug candidates which had been screened to show therapeutic activities could not be formulated into suitable oral dosage forms, which are the most preferred form of drug administration, due to poor aqueous solubility. These compounds were abandoned during preformulation stage because they did not exhibit sufficient solubility in the aqueous environment, implying reduced bioavailability upon administration and the inability to attain the necessary drug levels in blood for therapeutic effect. [Figure 1](#) depicts the possible events that can occur upon administering various oral dosage forms and it is obvious that there are many factors affecting the absorption of drug.

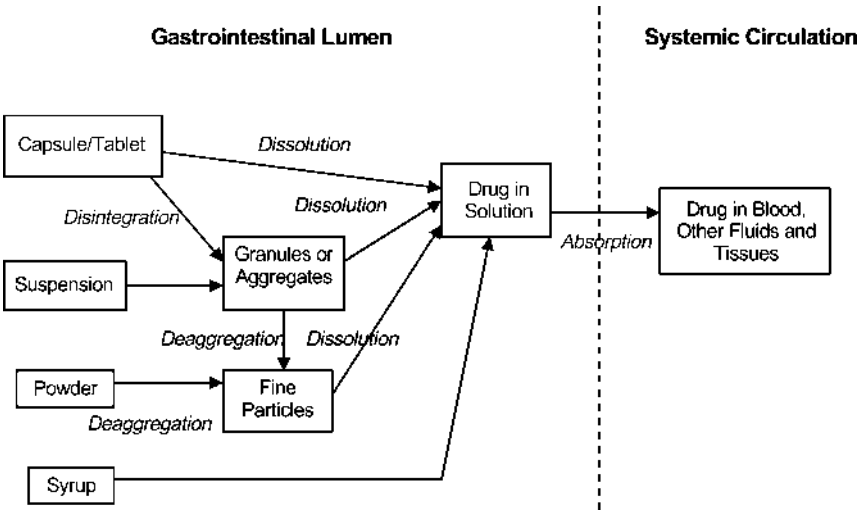
The factors can be broadly classified into patient or dosage-form related. The focus of the current chapter is to examine some of the dosage-form related factors which can be controlled from the formulator's perspective, to enhance the dissolution of the bioactive compounds in order to increase the bioavailability of poorly water-soluble compounds through the granulation process, which is making granules to be filled into capsules or tableted. Most of the dosage-form related factors are outlined in [Figure 2](#). This could be further classified into formulation-related or granulation-related factors.

Rapid release granulation is expected to benefit the class of compound where absorption is highly dependent on the dissolution of the drugs in the gastrointestinal tract, termed as Class II compounds under the Biopharmaceutics Classification Scheme ([Table 1](#)).

#### 1.1. Definition

Solution can be defined as a mixture of at least two components forming a single phase, which is homogenous at the molecular level. The transfer rate of molecules or ions from solid state into solution is known as dissolution rate and the extent to which this proceeds under a given set of conditions is known as solubility.





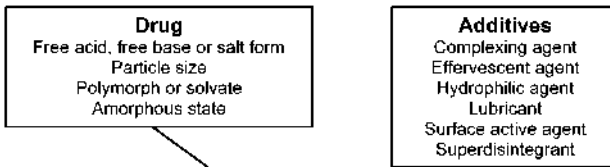
**Figure 1** Schematic illustration of the possible events upon administering various oral dosage forms.

Thus, the rate of solution (dissolution rate) and the amount that can be dissolved (solubility) are two separate concepts but in practice, high solubility is usually associated with high dissolution rate (2).

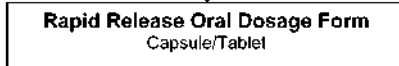
### 1.2. Factors Affecting Dissolution Rate

Most of the dosage-form related factors highlighted in Figure 2 can be explained by the terms in the modified Noyes–Whitney equation (3,4), which is as follows:

#### Formulation-Related Factors



#### Granulation-Related Factors



**Figure 2** Dosage-form related factors.

**Table 1** Biopharmaceutics Classification Scheme

Class	Solubility	Permeability
I	High	High
II	Low	High
III	High	Low
IV	Low	Low

Source: Amidon et al. (1)

$$\frac{dC}{dt} = \frac{AD(C_s - C)}{h} \quad (1.1)$$

where  $dC/dt$  is the dissolution rate,  $A$  is the surface area available for dissolution,  $D$  is the diffusion coefficient of the compound,  $C_s$  is the solubility of the compound in the dissolution medium,  $C$  is the concentration of drug in the dissolution medium at time  $t$ , and  $h$  is the thickness of the diffusion boundary layer adjacent to the surface of the dissolving compound (Table 2).

## 2. FORMULATION-RELATED FACTORS

### 2.1. Drug

#### 2.1.1. Free Acid, Free Base, or Salt Form

The use of the appropriate form of drug prior to granulation is of utmost importance to ensure the production of rapid release granules. Sodium salts of weak acids or hydrochloride salts of weak bases can cause marked increase in aqueous solubility when compared to the corresponding free acids or bases. This is attributed to an increase in interactions between drug and water, giving rise to a greater degree of ionic dissociation of the drug when it dissolves in water. An example of this effect is the aqueous solubilities of salicylic acid and its sodium salt, which are 1:550 and 1:1, respectively (2).

#### 2.1.2. Particle Size

The most common approach for improving the dissolution rate ( $dC/dt$ ) of drug from rapid release granules is to increase the surface area ( $A$ ) available for dissolution and this is often achieved by employing finely divided particles [Eq. (1.1)]. Size reduction has also been shown to decrease the diffusion boundary layer ( $h$ ) of sparingly soluble drugs (5–7). Hence, the combined effects of  $A$  and  $h$  improve the dissolution rate of the drug. Griseofulvin represents a classical example of a drug where improvement in rate of absorption can be brought about by an increase in dissolution rate due to the increase in surface area by size reduction. This drug, which was initially marketed as coarse particles, resulted in many cases of therapeutic failures due to low bioavailability. Kraml et al. (8) demonstrated that 0.5 g of micronized griseofulvin produced the same serum level as 1.0 g of the unmiconized form. Subsequently, the use of micronized griseofulvin enabled a dosage reduction and contributed not only to lower drug cost to the patient but more importantly, a decrease in therapeutic failures caused by poor absorption (9). However, size

**Table 2** Terms That are Being Affected by the Various Dosage-Form Related Factors

Term in modified Noyes–Whitney equation	Affected by	Comments
<i>A</i>	Formulation-related factors	
	Drug	
	Particle size	<i>A</i> is inversely related to the drug particle size
	Additives	
	Effervescent agent	Poorly water-soluble drug particles
	Hydrophilic agent	tend to form a coherent mass in the
	Surface active agent	dissolution medium; the dispersibility
	Superdisintegrant	of these particles can be achieved
		with the additives listed to enhance
		dissolution
<i>C<sub>s</sub></i>	Granulation-related factors	
	Granulating equipment	In general, these factors affect the
	Liquid binder	hardness of the granules; hardness
	Wet massing time	is usually associated with lower
	Tableting force	granule porosity and this will lead
<i>C<sub>s</sub></i>	Formulation-related factors	
	Drug	
	Free acid, free base or salt form	Sections 2.1.1, 2.1.3, and 2.1.4
	Polymorphs or solvates	
	Amorphous state	
	Additives	
Complexing agent	Sections 2.2.1 and 2.2.5	
Surface active agent		
<i>H</i>	Formulation-related factors	
	Drug	
	Particle size	The smaller the drug particle size the lower the diffusion boundary layer (5–7)
	Additives	
	Effervescent agent	Poorly water-soluble drug particles
Hydrophilic agent	tend to form a coherent mass in	
Surface active agent	the dissolution medium having a	
Superdisintegrant	large resultant diffusion boundary	
	layer; dispersing these particles into	
	individual particles decreases this value	
<i>D</i>	Granulation-related factors	
	Granulating equipment	Drug does not readily diffuse into the
	Liquid binder	dissolution medium from hard
	Wet massing time	granules
	Tableting force	
	Blending	Section 3.4

Source: Modified from Ref. 2.

reduction has its practical limits as micronized particles tend to aggregate due to the high surface energy per unit mass. Aggregation reduced the surface area available for dissolution and lowered the drug dissolution rate (10). Wetting effect is particularly important under such a situation as it increases the effective surface area (11). This principle is commonly applied in interactive mixtures (Section 2.1.2.1). In a study using rapid release granules, micronized DPC 961, which was an antiretroviral drug, was wet granulated by high shear and the granules were subsequently tableted and fed to beagle dogs (12). It was found that for the fasted dogs, tablets made from micronized DPC 961, which displayed higher *in vitro* dissolution, produced a higher plasma drug concentration due to faster dissolution and absorption. The effect of particle size reduction was not obvious for the nonfasted dogs, probably because the solubilization afforded by the nonfasted state was sufficient for rapid dissolution of drug irrespective of particle sizes. Hence, particle size of the drug is important if it is to be consumed before meals.

There are several micronization techniques available and they can be broadly classified into mechanical- and solution-based micronization (Table 3) (13).

Table 3 illustrates some of the commonly established micronization techniques. An example of a technique that could be viewed as a solution-based micronization is solvent deposition, which could be classified as a form of spray drying. The poorly soluble drug, tolbutamide, was dissolved in aqueous ammonia, and mixed with a core material, either low-substituted hydroxypropylcellulose or partly pregelatinized corn starch. The suspension was subsequently spray dried leaving a thin film of fine drug crystals on the surface of the core materials. The rapid solvent evaporation prevented the growth of large drug crystals. Using disintegrant as the core material further improved drug release because the swelling of disintegrant would dislodge the thin film of fine drug crystals from the core for better dissolution, thus effectively dispersing the fine drug crystals (14). This study illustrated the possibility of concurrent granulation with micronization. The concept was probably pioneered by Monkhouse and Lach (15,16) when they loaded poorly water-soluble drugs onto fumed silicon dioxide by dissolving the drugs in organic solvent and suspending the fumed silicon dioxide in the drug solution, simultaneously evaporating the organic solvent. The drugs loaded onto the fumed silicon dioxide improved the dissolution profiles. This improvement was attributed to particle size reduction and changes in the crystalline structures (Section 2.1.3). The crystalline nature of the drug has to be assessed after undergoing micronization as certain crystal forms may be more suitable for formulation of rapid release granules (Section 2.1.3). Drug can also be micronized with additives, usually water-soluble carriers, such that the intimate

**Table 3** Mechanical-Based and Solution-Based Micronization Techniques

---

Micronization technique

---

Mechanical-based micronization

Classification

Comminution

Solution-based micronization

Crystallization

Spray drying

Spray freezing

---

interaction between drug and additives enabled rapid drug release when in solution. This will be discussed under Solid Dispersion (Section 4).

**2.1.2.1. Interactive Mixtures.** The concept of interactive mixing was first introduced by Hersey (17) to describe the mixing of fine and cohesive particles. This form of mixing is different from random mixing because of the adhesion of fines to coarser particles (18). The adhesion may be due to many factors such as humidity, adsorption, chemisorption, surface tension, friction, and electrostatic forces, unlike random mixing where gravitational force predominates over the other types of adhesion forces. Interactive mixtures could be viewed as “miniature granules” since the fine drug and coarser particles exist as agglomerates. The forces of adhesion can be so great that it is able to resist the fluidization force in a fluid bed, thus facilitating the coating of the “miniature granules” (19).

The basic mechanism in enhancing the dissolution rate of a poorly water-soluble drug in an interactive mixture is by reduction of drug aggregates upon mixing with highly soluble and coarse carrier particles, thus improving the wettability of the micronized drug. By adding carrier particles, fine drug particles will adhere onto the coarser carrier particles, thereby increasing the exposed surface area for drug dissolution upon rapid concomitant dissolution of the carrier into the dissolution medium (20–22). Thus, the solubility of the coarse carrier particles plays an important role in the dissolution of the adhered drug. The use of carriers having surface active properties will further improve the dissolution rate of the drugs by solubilization effect during dissolution.

### 2.1.3. *Polymorphs and Solvates*

Drug can exist in one or more crystalline forms. The term crystalline implies that the structural units, known as unit cells, are repeated regularly and indefinitely in three-dimensional space. Crystalline forms of a drug can be further classified into polymorphs and solvates, also known as pseudopolymorphs. Crystalline polymorphs have the same chemical composition but different crystal structures because of the manner in which molecules arrange themselves in crystal lattices during crystallization. Solvates are crystalline forms containing solvent molecules in the crystal structures in stoichiometric or nonstoichiometric proportion. The differences in crystal packing of the polymorphs and solvates would mean that they differ in lattice energy and entropy, thereby significantly affecting physicochemical properties, one of which is the solubility of the drug (23,24). This implied that the dissolution and absorption of a poorly water-soluble drug may also be affected by the actual polymorphs or solvates present in the oral dosage forms. Usually, only one stable polymorph exists for a given set of environmental conditions. In terms of enhancing dissolution, it is better to employ metastable polymorphs of the drug. However, in processing, it is a manufacturer's nightmare as the use of metastable polymorphs may lead to stability problems on storage unless a way is found to stabilize the polymorph. Hence, it is always desirable to choose the most soluble and stable form of the drug during the initial stages of product development (25).

The choice of polymorph before granulation determines the dissolution rate. Otsuka et al. (26) found that the use of carbamazepine polymorphs I and IV, which are the respective anhydrate and dihydrate forms, gave rise to a higher dissolution rate than polymorphs II and III, which are the anhydride forms, when hydroxypropylcellulose solution was employed as binder. This was because the tablets made from polymorphs I and IV were not as hard and thus disintegrated faster upon contact with the

dissolution medium. During wet granulation, forms I, II, and III were converted to form IV. Thus, the anhydrate and the anhydrides were converted to the dihydrate form. Only 2.5% of form I was converted as compared to 80.3% of form II and 35.2% of form III. The granulation was unsuccessful when forms II and III were employed. This was because water from the liquid binder was used to hydrate these two polymorph forms and little was available for wet massing. Only upon adding more water could the granule yield be improved. Upon drying, the transformed dihydrate lost the water molecules to form polymorph III. Drying resulted in a reduction in particle size as the removal of solvent from solvates is a size reduction process as well. Thus, the specific surface area for granules obtained using forms II and III were higher than forms I and IV, therefore contributing to higher mechanical strength of the tablet and hence poorer dissolution. The effect of the types of liquid binder on polymorphic conversion is clearly illustrated by the work carried out by Otsuka et al. (27) when it was found that carbamazepine form I was readily converted to the dihydrate form, which is form IV, by using 50% aqueous ethanol solution but relatively unaffected by distilled water or ethanol. Thus, this implies that if 50% aqueous ethanol solution is to be used, the resultant tablets would be poorly soluble as the above-mentioned transformations would have occurred.

#### 2.1.4. Amorphous State

Amorphous state can be defined with reference to a crystalline solid. It is similar to crystalline solid as an amorphous solid has short-range molecular arrangement with neighboring molecules, but unlike crystalline solid, an amorphous solid has no long-range order of molecular packing. The major interest in amorphous solids is in their higher solubilities and dissolution properties as well as better compressibility as compared to the crystalline forms. However, amorphous solids are generally not as stable physically and chemically. Currently, many researchers are exploring various methods to maintain the stability of drugs in their amorphous state. Methods include stabilization of the amorphous solids by additives and storing the amorphous state under appropriate storage temperatures (28).

## 2.2. Additives

### 2.2.1. Complexing Agent

An additive is able to improve the dissolution of a poorly water-soluble drug by forming a water-soluble intermolecular complex. The additive is called solubilizing

**Table 4** Solubilizing Agents for Poorly Soluble Substances

Poorly water-soluble substance	Solubilizing agent
Caffeine	Sodium benzoate, sodium salicylate
Calcium theobromine	Calcium salicylate
Iodine	Potassium iodide
Mephensin	Salicylic acid
Quinine hydrochloride	Urethane, carbamide
Riboflavin	Nicotinic amide
Theobromine	Sodium salicylate
Theophylline	Sodium acetate, ethylenediamine

Source: From Ref. 29.

agent and it must be present at an optimal concentration to maximize the solubility of a poorly water-soluble drug. Table 4 lists some of the common solubilizing agents. One commonly used additive is cyclodextrin. Cyclodextrins are bucket-shaped oligosaccharides produced from starch.

As a result of their molecular structures and shapes, cyclodextrins are able to entrap poorly water-soluble drugs in the hydrophobic cavities forming water-soluble inclusion complexes with the poorly water-soluble drugs. Cavallari et al. (30) showed that complexation and granulation of piroxicam with  $\beta$ -cyclodextrin by steam granulation in a single process improved in vitro drug release when compared to a physical mixture of drug and  $\beta$ -cyclodextrin in the same composition. 2-Hydroxypropyl- $\beta$ -cyclodextrin was employed by Uekama et al. (31) to form water-soluble inclusion complex with nifedipine. The drug and additive were dissolved in ethanol-dichloromethane and subsequently spray dried. Tablets prepared using the inclusion complexes were found to promote nifedipine in vitro release rate. Upon feeding the test tablets to dogs, superior oral bioavailability was obtained. Storage at 60°C and 75% relative humidity did not result in nifedipine crystal growth because the nifedipine molecules were basically entrapped within the 2-hydroxypropyl- $\beta$ -cyclodextrin, minimizing the opportunity for the nifedipine molecules coming together and recrystallizing. Thus, the stability in dissolution profile could be achieved throughout the entire period of study.

### 2.2.2. Effervescent Agent

Effervescence is defined as the evolution of bubbles of gas from a liquid as the result of a chemical reaction. The generation of gas, which is usually carbon dioxide, is usually achieved by spontaneous chemical reaction between a soluble acid source and an alkali metal carbonate in the presence of water. The reaction can be triggered in the presence of a small amount of water, thus moisture protection of such oral dosage forms is paramount. This is because effervescence reaction when initiated will proceed spontaneously because one of the by-products is water.

Several researchers had found that the bioavailability of aspirin from effervescent tablet was higher than conventional or enteric-coated tablets (32–34). The reasons for this included the dramatic disintegration rate of the tablets that enabled rapid release of the drug particles for dissolution and the increase in gastric emptying rate.

### 2.2.3. Hydrophilic Agent

In the formulation of rapid release granules, it is important to consider the formulation in its totality. It is always better to employ more hydrophilic agents which may be water-soluble or water-insoluble as binders or fillers in the formulation so that water penetration into the granules will not be impeded. Hydrophilic agents commonly employed include hydroxypropylcellulose, hydropropylmethylcellulose, lactose, microcrystalline cellulose, polyvinylpyrrolidone, starch, and many others. These additives aid in wetting the poorly water-soluble drug. Polyvinylpyrrolidone K30 was able to improve the wetting of nifedipine complexed with 2-hydroxypropyl- $\beta$ -cyclodextrin, thus negating the decrease in nifedipine release brought about by the poor wettability and good compressibility of the complex (35).

#### 2.2.4. *Lubricant*

Lubricant is employed in a formulation to facilitate the ejection of tablets from the die. Excessive sticking of tablets to the punches or wear of punches and dies will be reduced. Lubricant functions by forming a thin film at the interface of the tablet and die, reducing the shearing force during the ejection of tablet. An optimum amount of lubricant must be used for each formulation in order to optimize the drug dissolution. Excess lubricant interferes with both disintegration and bioavailability by waterproofing the granules and tablets. Gordon (36) found that doubling the quantity of magnesium stearate to be mixed with naproxen granules before tableting resulted in a slower drug dissolution rate.

#### 2.2.5. *Surface Active Agent*

This additive is capable of forming aggregates called micelles above the critical micelle concentration. This is the major distinguishing feature between surface active agent and complexing agent. In an aqueous environment, the cores of these aggregates resemble a separate organic phase providing a suitable environment for poorly water-soluble drugs. Solubilization results in the increase in the aqueous solubility of drugs and aids dissolution. It is also able to improve wetting of the granules. Surfactant can also potentially disrupt the integrity of membranes to enhance drug absorption.

Sodium lauryl sulfate was employed in the formulation of ibuprofen tablet to enhance ibuprofen dissolution. Sodium lauryl sulfate was incorporated during the wet granulation phase and the resultant dissolution profiles were even better than commercial products (37). In another study by Gohel and Patel (38), the authors used a combination of hydrophilic and surface active agents to bring about rapid release of nimesulide. The hydrophilic agents studied included polyethylene glycol 400, propylene glycol and polyvinylpyrrolidone K30, whereas the surface active agents investigated were sodium lauryl sulfate and polyoxyethylene sorbitan monooleate. Aqueous solutions of the hydrophilic agents and surface active agents were mixed with the drug before the suspension was further mixed with the rest of the powder mass during granulation. Thus, additives were incorporated as part of the liquid binder. The granules formed were shown to display enhanced dissolution as compared to the pure drug and the improvement in drug release property was attributed to increase in wettability and the solubilizing effects by the additives. The solubilizing effect of sodium lauryl sulfate on griseofulvin in the griseofulvin-polyethylene glycol 3000 system was demonstrated by Sjökvist et al. (39). At an optimum concentration of sodium lauryl sulfate, the crystalline griseofulvin was converted into a solubilized state, which was in the molecular form. The change of phase could be detected by x-ray diffractometry and differential scanning calorimetry. Thus, the drug molecules existing in a molecularly dispersed state could be easily released into the dissolution medium upon contact with the dissolution medium.

Dry granulation via slugging and roller compaction of hydroxypropylmethylcellulose with naproxen, nifedipine, or carbazepine resulted in improvement of their dissolution profiles. The mechanism for dissolution enhancement was believed to be a microenvironment hydroxypropylmethylcellulose surfactant effect facilitated by placing the hydroxypropylmethylcellulose in close proximity to the drug as simple mixing did not result in enhanced dissolution (40). Another example was the use of polyethylene 40 hydrogenated castor oil to improve the *in vitro* release of hydrochlorothiazide (41). The release was dependent on the concentration of surface active



agent and a higher concentration gave rise to better dissolution. Mehta et al. (42) managed to enhance nifedipine release from granules with copolymer of propylene oxide and ethylene oxide as the surface active agent.

### 2.2.6. Superdisintegrant

The addition of disintegrant is to facilitate the breakup of tablet, thus presenting the micronized drug to the dissolution medium. In general, for a drug having solubility of 10 µg/mL or less, disintegration rate of the solid dosage form has a profound effect on the dissolution profile (43). Superdisintegrants represent a subclass of disintegrants that are associated with dramatic disintegration rates. Some of the common superdisintegrants are croscopovidone, croscamellose sodium, and sodium starch glycolate. Studies in the 1970s and 1980s usually used the disintegration test to investigate the effect of incorporating superdisintegrants into formulations. Even though tablet disintegration is often a necessary precursor for drug dissolution, it does not ensure that the drug of interest dissolves but in practice, the two are highly correlated. In 1993, Gordon and coworkers (44) studied the effect of superdisintegrants employed during the wet granulation process in terms of dissolution and confirmed the usefulness of superdisintegrants in enhancing dissolution of *p*-amino-benzoic acid in tablets containing mainly lactose, dibasic calcium phosphate dehydrate, or naproxen, in order to vary the water affinity of the tablet manufactured. Bolhuis et al. (45) also verified the effectiveness of superdisintegrants in improving the dissolution of methylprednisolone and phenylbutazone. Granules produced from wet granulation were either filled into capsule or tableted. Both types of oral dosage forms displayed enhanced dissolution. Superdisintegrants were found to be useful in melt granulation as well as where the intragranular addition of croscopovidone during the melt granulation of carbamazepine, polyethylene glycol 4000, and lactose monohydrate was able to reduce the dissolution  $t_{90\%}$  by half (46).

Steps under Dry Granulation	Steps under Wet Granulation	Description of the Various Step	Possible Factors Affecting Dissolution
Premixing	Premixing	Mixing of drug and additives	Improve the dissolution of drug by interactive mixing (Section 2.1.2.1).
	Wet Massing	Mixing of the powder mass, consisting of drug and additives with a liquid binder.	Dissolution is dependent on granulating equipment, force supplied to mix the powder mass, duration of wet massing, type and amount of liquid binder.
	Screening	Extrusion of wetted powder mass through a screen to form granules.	Screen size affects the granule size which in turn will affect the dissolution.
Slugging/Roller Compaction		Formation of powder plugs by compression.	Dissolution is dependent on the duration and force of slugging/roller compaction.
Milling		Milling of the powder plugs.	Granule size affects the dissolution.
	Drying	Drying of the wet granules.	
Screening	Screening	Optimizing the size of granules.	Granule size affects the dissolution.
Blending	Blending	Blending of the lubricant, glidant and superdisintegrant with the granules.	Dissolution is dependent on blending equipment, force, duration of blending and the quantity of lubricant.
Capsule Filling / Tableting	Capsule Filling / Tableting	Formation of capsules or tablets from the blended granules.	Dissolution is dependent on the tableting force.

**Figure 3** Possible factors affecting the rapid release of drug in the respective steps under dry and wet granulation methods.

### 3. GRANULATION-RELATED FACTORS

Figure 3 refers to some of the common steps in dry and wet granulation methods and some of the factors that may affect the final release of drug from capsules or tablets made from the granules.

The first step of both methods, which is interactive mixing, plays an important part in improving the dissolution of poorly soluble drug because the mixing of micronized drug with the appropriate additives reduces the cohesiveness of the drug particles, leading to better dissolution of the drug (Section 2.1.2.1). Mitchell et al. (40) processed poorly water-soluble drugs with hydropropylmethylcellulose by dry granulation and achieved enhanced drug dissolution probably due to the reduction in cohesiveness of the drugs and surface active property of hydropropylmethylcellulose. Levy et al. (47) reported that the dissolution rate of salicylic acid tablets increased with a decrease in the granule size prepared by the slugging method. Gao et al. (48) improved the dissolution of an experimental drug by carrying out wet granulation in fluid bed and high-shear mixer and this could be attributed to the combined effects of employing the micronized form of the drug, a surface active agent, a superdisintegrant, and reduction in the cohesiveness of the drug by interactive mixing.

#### 3.1. Liquid Binder

Wet granulation offers an opportunity for the transformation of crystal forms and the choice of the liquid binder plays an important role in determining the final crystal form of the drug in the granules obtained (Section 2.1.3). Transformation usually occurs during the addition of liquid binder to the powder mass during wet massing and drying of the formed granules. Addition of the binder could be viewed as suspending drug in a mixture of solvent and additives, hence, encouraging transformation of anhydrites to solvated forms. If sufficient liquid binder is added, this could be viewed as a solution step and subsequent drying of granules as the recrystallization step. Thus, close attention has to be paid to polymorph conversion during wet granulation. An example of such a situation is theophylline. Theophylline readily converts to the monohydrate form (II) upon exposure to water during wet granulation. The hydration process could be followed closely using near-infrared spectroscopy (49) and charge-coupled device Raman spectroscopy (50). This conversion could not be prevented by having high water absorbing capacity additive such as the silicified microcrystalline cellulose because the minimal amount of water for effective wet massing was sufficient to trigger this conversion (51). Theophylline monohydrate under vacuum dehydration forms the metastable anhydrate ( $I^*$ ). This metastable anhydrate on storage recrystallized to stable anhydrous form (I) and in the process, formed solid bridges within the tablet (52). A decrease in dissolution would result if the recrystallization process were not prevented. The use of water as the liquid binder also affected the dissolution of naproxen sodium because of drug hydration (53) resulting in a poorer dissolution of the drug. Thus, if wet granulation has to be carried out for these drugs, and in order to maintain rapid dissolution, polymorphic conversion may be prevented by using ethanol as the liquid binder.

The solubility of drug in the liquid binder also affects the dissolution of the resulting capsules or tablets made from these granules. This was illustrated by a study carried out by Wu et al. (54) who found a correlation between dissolution rate constants of zindotrine and the solubility of zindotrine in liquid binder containing varying ethanol concentrations. This was explained by the dissolution of a certain

amount of zindotrine, followed by the recrystallization of fine crystals during the drying phase of the granules. The subsequent enhancement in dissolution was due to the finer crystals formed due to the recrystallization process. Thus, the drug had effectively undergone the micronization process during wet granulation.

The quantity of liquid binder also gives rise to different dissolution profiles. A low amount used would result in the production of smaller granules and the resultant tablets formed displayed much faster dissolution as compared to granules formed using a higher amount of liquid binder (36). Besides forming larger granules, a higher amount of liquid binder used is also expected to increase the hardness of granules. Hard tablets will give rise to poorer dissolution because the tablets require more time to break up (55). This observation was found to be dependent on the moisture content of the tablets. At moisture contents of 1.6% and 2.0%, ticlopidine hydrochloride dissolution was highly dependent on the tablet strength. However, with moisture contents of more than 3.0%, the drug dissolution was independent of tablet strength (56).

### 3.2. Granulating Equipment

The use of the appropriate granulating equipment also plays a part in the release rate of the drug. Acetaminophen beads made from extrusion/spheronization were compared to beads made from pan coating. Beads made from pan coating displayed higher dissolution rates as compared to those made from the former method. This was attributed to the disintegration of pan-coated beads and the ones made from extrusion/spheronization were denser and less friable due to the higher energy input during wet massing and thus did not disintegrate during dissolution. Thus, the selection of equipment for wet granulation affects the hardness of the granules and ultimately influences drug release (57). Chowhan et al. (56,58) also reported that granules made from high-speed shear mixer were lower in porosity as compared to those prepared from planetary mixer. Low porosity did not facilitate solvent penetration and, hence, caused poorer drug dissolution.

### 3.3. Wet Massing

Wet massing was found to play an important factor in the dissolution rate of dyphylline. Increasing the time during wet massing resulted in an increase in bulk density of the granules. The maximum bulk density value coincided with the minimum dissolution rate indicating that the dissolution of drug required the diffusion of dissolution medium into granules via pores to dissolve the drug (59). Thus, the duration of wet massing affects the hardness of granules and ultimately, dissolution of the drug.

### 3.4. Blending

The dissolution rate is affected by the type of blending equipment employed, the duration of blending of granules with disintegrant, glidant, and lubricant. It was found that the type of blender affected the distribution of magnesium stearate and hence, drug dissolution. High-speed blender was employed to mix interactive mixture of theophylline with magnesium stearate before tableting. It was found that a 15 min duration was sufficient to impair theophylline dissolution whereas an impairment of dissolution was not observed for a lower-speed blender. The impairment to drug dissolution increased with an increase in the duration of blending (60). This was

attributed to the coating of the granules with a thin film of lubricant, a water-repellant, and hence, compromising the wetting of the granules.

## 4. SOLID DISPERSION

The term, solid dispersion, refers to a composite solid of one or more drugs in a water-soluble carrier or matrix prepared by melt (fusion), solvent, or melt–solvent method (61). Solid dispersions have been traditionally employed to enhance the dissolution rate of drug, with a view to improve bioavailability. The common approach to achieve rapid drug dissolution is to use inert but water-soluble carriers such as polyethylene glycol or polyvinylpyrrolidone. Solid dispersion enhances the dissolution of drugs by the formation of fine drug crystals via the eutectic or monotectic systems. Hence, solid dispersion could also be viewed as a size reduction technique (Section 2.1.2). Under certain conditions, the drug may be entrapped in the water-soluble carrier matrix without undergoing recrystallization to form an amorphous solid solution (Section 2.1.4), a water-soluble complex with the carrier (Section 2.2.1), or it may dissolve in the carrier to form a true solid solution. The drug particles in solid dispersions were released as fine or amorphous colloidal entities upon dissolution of the matrix, enhancing drug dissolution rate. This concept is deemed to be utilized for drug enhancement if the drug and water-soluble carriers have been fused prior to or during granulation via any of the three preparation methods (Section 4.1). [Table 5](#) lists a number of processes that employ the concept of solid dispersion and the ones suitable for large-scale manufacturing are further discussed under Section 4.2. Excellent reviews have been published in this area for further reading (61,96–98).

### 4.1. Preparation Methods

#### 4.1.1. *Melt/Fusion Method*

Early pioneers in the field of solid dispersions were Sekiguchi and Obi (99) who utilized the melt or fusion method to produce dispersion systems. Essentially, a physical mixture of a drug and a water-soluble carrier was heated directly until melting occurred. The molten mixture was subsequently solidified in an ice bath. The cooled mass was milled and sieved. Administration of the product obtained was found to improve absorption of the drug. Subsequent workers proposed numerous variations to this method.

#### 4.1.2. *Solvent Method*

Tachibana and Nakumara (100) introduced the concept of solid dispersion preparation by a solvent method. The proposed method involved dissolving the drug and water-soluble carrier in a common solvent and subsequent evaporation of the solvent under vacuum. Solid dispersions produced by this manner are commonly known as coprecipitates, a term coined by Bates (101). This term is a misnomer and should be appropriately renamed as coevaporates. In a strict sense, coprecipitates are formed by the addition of a second solvent to the original solution, which decreases the solubilities of the drug and carrier in the resultant solutions, thus coprecipitating them.

#### 4.1.3. *Melt-Solvent Method*

This is a hybrid of the two methods discussed. The drug is dissolved in a suitable organic solvent and the solution is incorporated directly into a molten carrier. Subsequently, the organic solvent is evaporated off (61).

**Table 5** Summary of the Processes Reported in the Literature for Solid Dispersion Production

Preparation method	Process	Investigators
Melt method	Compression moulding	Broman et al. (62)
	Extrusion/spheronization	Vervaeet et al. (41), Vervaeet and Remon (63), Mehta et al. (42)
	Melt extrusion	El-Egakey et al. (64), Hülsmann et al. (65), Forster et al. (66), Perissutti et al. (67), Ndindayino et al. (68)
	Hot-spin melting	Dittgen et al. (69)
	In situ granulation	Ford and Rubinstein (70)
	Melt granulation	Kinget and Kemel (71), Passerini et al. (72), Perissutti et al. (46), Gupta et al. (73–75)
	Roll mixing	Nozawa et al. (76,77)
	Ultrasound-assisted compaction	Fini et al. (78)
	Ultrasound-assisted spray congealing	Passerini et al. (79), Fini et al. (78)
	Solvent method	Lyophilization
Solvent deposition		Monkhouse and Lach (15,16), Kim and Jarowski (83), Takeuchi (14)
Solvent extrusion/spheronization		Deasy and Gouldson (84)
Spray drying		Corrigan and Holohan (85), Arias et al. (86)
Spray freezing into liquid		Hu et al. (87), Rogers et al. (13,88–91)
Steam granulation		Cavallari et al. (30), Rodriguez et al. (92)
Supercritical carbon dioxide		Senčar-Božič et al. (93), Moneghini et al. (94), Corrigan and Crean (95)

## 4.2. Processes

### 4.2.1. Melt Extrusion

This process originated from the plastic industry and it entails conversion of a raw material into a product of uniform shape and density. The drug and additives are usually mixed followed by forcing the powder mass through a die under controlled conditions. The extruded mixtures always exhibited more rapid release of drug vs. the corresponding physical mixtures as shown by Perissutti et al. (67) using carbamazepine as the model drug. Hülsmann et al. (65) extruded 30% of 17- $\beta$ -estradiol hemihydrate with 30% polyvinylpyrrolidone K30 and 40% saccharose-monopalmitate, which, respectively, functioned as a water-soluble carrier and a surface active agent, to achieve a good release of drug and this was unchanged upon tableting as the dissolution profiles of the exudates and tablets were similar. Ndindayino et al. (68) used this technique to produce hydrochlorothiazide tablets by directly extruding the melt into a tablet-shaped cavity. The molded tablet thus formed displayed higher in vitro dissolution and relative bioavailability in healthy volunteers. The improvement in dissolution rate is drug specific as demonstrated by Forster et al. (66) after investigating the extrusion of indomethacin, lacidipine, nifedipine, and tolbutamide with either polyvinylpyrrolidone

K30 or copolymer of polyvinylpyrrolidone and vinyl acetate, both of which were acting as water-soluble carriers. The stability of the extrudates was speculated to be dependent on the degree of hydrogen bonding between the drug and polymer. An excellent review by Breitenbach (102) provides an in-depth view of this process in the rapid release of drug.

A possible modification of this process is the extrusion/spheronization, where the extrudates are spheronized to form pellets. Pellets are highly spherical granules and Vervaeke et al. (41) found that the use of polyethylene glycol 400 as the water-soluble carrier and polyethylene glycol 40 hydrogenated castor oil as the surface active agent was able to enhance the *in vitro* release of the hydrochlorothiazide pellets produced. The pellets were subsequently filled in hard gelatin capsule and fed to eight Caucasian male volunteers. Comparison of mean serum concentration of volunteers between a commercial product and the pellets indicated that dissolution and absorption from the pellets were faster (63). A slightly different method was employed by Mehta et al. (42) for rapid drug release. They prepared a solid dispersion of nifedipine and copolymer of propylene oxide and ethylene oxide serving as the surface active agent, and the resultant powder was mixed with other excipients before extrusion. The nifedipine drug release was reduced to 12 h from 24 h as compared to when only micronized nifedipine powder was used.

Deasy and Gouldson (84) employed organic solvents, instead of using nonsolvent extrusion, for wet massing of the powder. The wetted mass was left aside for 12 h for *in situ* formation of enteric coprecipitate of nifedipine with hydroxypropylmethylcellulose phthalate, which is a water-soluble carrier at pH 6.8. However, the release of the nifedipine was poor as indicated by *in vitro* dissolution upon changing the dissolution medium from pH 1.2 to 6.8, to simulate the passage of the pellets through the gastrointestinal tract. Enhanced release was only achieved by the addition of sodium lauryl sulfate and sodium starch glycolate, which, respectively, acted as the surface active agent and superdisintegrant. The combined effects of wetting, solubilization, and disintegration exposed the enteric coprecipitates for rapid dissolution at pH 6.8.

#### 4.2.2. *Melt Granulation*

Melt granulation is a process by which powders are agglomerated with the aid of a binder, in either a molten state or solid state that melts during the process. The apparatus of choice is a high-shear mixer, where the temperature of a powder can be raised above the melting point of a meltable binder by either a heating jacket or frictional forces generated by the impeller blades. Liquid binding is possible by the molten binder, thus melt granulation does not require the use of solvents. The choice of the meltable binder plays an important role in the process. It has to melt at a relatively low temperature of 50–80°C. The use of hydrophilic binder that melts at a low temperature will aid in the rapid release of drug. Passerini and coworkers (72) used a copolymer of ethylene glycol and propylene glycol as the surface active agent, to achieve fast release ibuprofen granules. The improvement in dissolution could be correlated to the formation of a eutectic mixture between the drug and binder, hence utilizing the solid dispersion concept (Section 4). Polyethylene glycol 4000 and lactose monohydrate were employed as the hydrophilic meltable binder and hydrophilic filler, respectively, by Perissutti et al. (46), in the formulation of rapid release carbamazepine tablets by the melt granulation process. Dissolution

profiles of the granules were found to be better than physical mixtures of the same compositions and the pure drug.

Gupta and coworkers (73) employed a variation of the above method. They first formed a molten mixture of drug and polyglycolized glycerides, which was the surface active agent employed, before adding this to a surface adsorbent such as magnesium aluminosilicate. The use of a surface adsorbent is to form granules with good flow and compressibility properties. The granules produced had enhanced dissolution properties as compared to the physical mixtures or pure drug. Tableting further improved the release rate. Storage under 40°C and 75% relative humidity also improved the dissolution rate. This was attributed to an increase in the degree of hydrogen bonding between drug and adsorbent under elevated temperatures. This was mediated by the solubility of the drug in the polyglycolized glycerides matrix (74,75).

#### 4.2.3. *Roll Mixing*

Roll mixing involves the feeding of the powder mix through two rollers. The powder mass usually includes the drug with one or more water-soluble carriers. Depending on appropriate processing conditions such as roller pressure or the use of solvent, the drug may be converted into an amorphous state. Nozawa et al. (76) managed to improve phenytoin *in vitro* dissolution release by roll mixing of the drug and polyvinylpyrrolidone K30, which served as the water-soluble carrier, as compared to the physical mixtures and coprecipitates. The use of an organic solvent such as ethanol would further improve the dissolution of the drug. Nozawa et al. (77) employed this solvent during the roller mixing of nifedipine with two water-soluble carriers, polyvinylpyrrolidone K30 and polyethylene glycol 1500. They were able to achieve a 400 times higher dissolution rate as compared to nifedipine alone.

#### 4.2.4. *Lyophilization*

Lyophilization, also popularly known as freeze drying, is a process whereby water is sublimed from frozen solutions, frozen suspensions, or frozen emulsions; under reduced pressure and temperature, leaving a dry porous mass of approximately the same shape and size as the original frozen mass. Lyophilization essentially consists of three steps, freezing, primary drying, and secondary drying. The materials are cooled until they are frozen. Primary drying is accomplished under vacuum and slight heating to remove most of the water by sublimation. The last stage is to remove sorbed water, which is carried out under elevated temperature. The lyophilization technology has been applied to the formation of rapid dispersible tablets. This type of dosage form caters mainly to the pediatric and geriatric patients who experience difficulties in swallowing. This also caters to active working patients when there is limited access to water. The ease of administration will decrease the incidence of noncompliance. The clinical effects of some drugs are enhanced when formulated into this dosage form as pregastric absorption from the mouth, pharynx, and esophagus will increase the bioavailability and decrease the side effects. The first-pass metabolism could also be bypassed. The most notable lyophilization process in the pharmaceutical industry was called Zydis Technology, which was codeveloped by Wyeth Laboratories and R. P. Scherer (103). This technology essentially involved the filling of blister pocket with a suspension of drug followed by freeze drying to form a porous tablet of sufficient strength before sealing of the blister pack (104). Thus, this technology could be viewed as a “macrogranulation”, whereby each tablet

is considered a “macrogranule.” Instead of lyophilizing a suspension, Corveleyn and Remon (81) managed to lyophilize an emulsion of hydrochlorothiazide into a tablet. Disadvantages of lyophilized tablets include poor tablet strength and tendency to be disturbed by air currents during sealing. This problem was examined by Thapa et al. (105) and overcome by lyophilization of sealed liquid via holes pierced through impermeable membrane. The lyophilization technology provides an opportunity for the formation of amorphous solid solution and enhanced drug release by solid dispersion concept. This technique had been successfully employed by Corveleyn and Remon (80,82) to produce lyophilized hydrochlorothiazide tablets displaying better in vitro dissolution as well as higher bioavailability in human volunteers.

#### 4.2.5. *Steam Granulation*

Steam granulation is a derivative of wet granulation technique, which involves the use of steam instead of traditional liquid binder. Instead of spraying the liquid binder, steam is emitted into the wet massing chamber. The processing time is short because less moisture is needed as steam has a higher diffusion rate into the powder mass, achieving a higher distribution of the binder. Another reason is the more favorable thermal balance during the drying step. This is because after condensation of the steam in the powder mass, water forms a hot thin film and this requires only a small amount of energy for vaporization as compared to evaporating the water from room temperature. This process was proposed by Rodriguez et al. (92) and they successfully produced diclofenac-polyethylene glycol 4000 rapid release granules whereby polyethylene glycol 4000 acted as the water-soluble carrier. The authors compared the granules with granules manufactured from wet and melt granulation techniques and found that the granules produced were more spherical and had a larger surface area. The larger surface area was proposed to enhance drug release. This group of researchers also used steam to complex piroxicam with  $\beta$ -cyclodextrin, as the complexing agent, forming steam granulated granules simultaneously, thus carrying out two processes in a single step to produce granules having dissolution profiles better than the original drug or a physical mixture of the two (30).

## 5. CONCLUSIONS

The preparation of rapid release granules for capsule or tablet preparation is a multi-factorial situation whereby it has to be approached concurrently, in a number of ways in order to achieve the desired end result. This approach is dependent on a number of factors, which could be broadly divided into formulation-related and granulation-related, but in reality, they are closely related. This chapter aims to highlight the key factors that the formulator has to consider in order to optimize the dissolution properties in the preformulation stage to end product so that appropriate decisions could be made pertaining to the selection of the form of drug to be presented, additives to be used, granulation methods employed, and processing variables to be controlled, and the employment of solid dispersion processes.

## ACKNOWLEDGMENT

The authors thank Ms. Loh Zhi Hui for assisting in the literature search.



## REFERENCES

1. Amidon GL, Lennernäs H, Shah VP, Crison JR. A theoretical basis for a biopharmaceutical drug classification: the correlation of in vitro drug product dissolution and in vivo bioavailability. *Pharm Res* 1995; 12(3):413–420.
2. Aulton M. Dissolution and solubility. Aulton AE, ed. *Pharmaceutics: The Science of Dosage Form Design*. Edinburgh: Churchill Livingstone, 2000:15–32.
3. Noyes AA, Whitney WR. The rate of solution of solid substances in their own solutions. *J Am Chem Soc* 1897; 19:930–934.
4. Nernst W. Theorie der reaktionsgeschwindigkeit in heterogenen systemen. *Z Phys Chem* 1904; 47:52–55.
5. Anderberg EK, Bisrat M, Nyström C. Physicochemical aspects of drug release VII. The effect of surfactant concentration and drug particle size on solubility and dissolution rate of felodipine, a sparingly soluble drug. *Int J Pharm* 1988; 47:67–77.
6. Bisrat M, Nyström C. Physicochemical aspects of drug release VIII. The relation between particle size and surface specific dissolution rate in agitated suspensions. *Int J Pharm* 1988; 47:223–231.
7. Bisrat M, Anderberg EK, Barnett MI, Nyström C. Physicochemical aspects of drug release XV. Investigation of diffusional transport in dissolution of suspended, sparingly soluble drugs. *Int J Pharm* 1992; 80:191–201.
8. Kraml M, Dubuc J, Gaudry R. Gastrointestinal absorption of griseofulvin: II. Influence of particle size in man. *Antibiot Chemother* 1962; 12(4):239–242.
9. Levy G. Effect of particle size on dissolution and gastrointestinal absorption rates of pharmaceuticals. *Am J Pharm* 1963; 135:78–92.
10. Lin SL, Menig J, Lachman L. Interdependence of physiological surfactant and drug particle size on the dissolution behavior of water-insoluble drugs. *J Pharm Sci* 1968; 57(12):2143–2148.
11. Craig DQM. Polyethylene glycols and drug release. *Drug Dev Ind Pharm* 1990; 16(17):2501–2526.
12. Aungst BJ, Nguyen NH, Taylor NJ, Bindra DS. Formulation and food effects on the oral absorption of a poorly water soluble, highly permeable antiretroviral agent. *J Pharm Sci* 2002; 91(6):1390–1395.
13. Rogers TL, Johnston KP, Williams RO. Solution-based particle formation of pharmaceutical powders by supercritical or compressed fluid CO<sub>2</sub> and cryogenic spray-freezing technologies. *Drug Dev Ind Pharm* 2001; 27(10):1003–1015.
14. Takeuchi H, Handa T, Kawashima Y. Enhancement of the dissolution rate of a poorly water-soluble drug (tolbutamide) by a spray-drying solvent deposition method and disintegrants. *J Pharm Pharmacol* 1987; 39:769–773.
15. Monkhouse DC, Lach JL. Use of adsorbents in enhancement of drug dissolution I. *J Pharm Sci* 1972; 61(9):1430–1435.
16. Monkhouse DC, Lach JL. Use of adsorbents in enhancement of drug dissolution II. *J Pharm Sci* 1972; 61(9):1435–1441.
17. Hersey JA. Ordered mixing: a new concept in powder mixing practice. *Powder Technol* 1975; 11:41–44.
18. Hersey JA. Preparation and properties of ordered mixtures. *Aust J Pharm Sci* 1977; 6(1):29–31.
19. Thiel WJ, Sberna FJ. Fluidized bed film coating of an interactive powder mixture to produce microencapsulated 2–5 μm particles. *J Pharm Pharmacol* 1986; 38:166–171.
20. McGinity JW, Ku CT, Bodmeier R, Harris MR. Dissolution and uniformity properties of ordered mixes of micronized griseofulvin and a directly compressible excipient. *Drug Dev Ind Pharm* 1985; 11(4):891–900.
21. Nyström C, Westerberg M. The use of ordered mixtures for improving the dissolution rate of low solubility compounds. *J Pharm Pharmacol* 1986; 38:161–165.

22. Ibrahim H, Sallam E, Takieddin M, Shamat MA. Dissolution characteristics of interactive powder mixture. Part one: effect of solubility and particle size of excipients. *Drug Dev Ind Pharm* 1988; 14(9):1249–1276.
23. Udupa N. Characterization of different crystal forms of ibuprofen, tinidazole and lorazepam. *Drug Dev Ind Pharm* 1990; 16(9):1591–1596.
24. Gul MK, Zhu J. Preparation, characterization, and evaluation of physicochemical properties of different crystalline forms of ibuprofen. *Drug Dev Ind Pharm* 1998; 24(5):463–471.
25. Vippagunta SR, Brittain HG, Grant DJW. Crystalline solids. *Adv Drug Delivery Rev* 2001; 48:3–26.
26. Otsuka M, Hasegawa H, Matsuda Y. Effect of polymorphic forms of bulk powders on pharmaceutical properties of carbamazepine granules. *Chem Pharm Bull* 1999; 47(6):852–856.
27. Otsuka M, Hasegawa H, Matsuda Y. Effect of polymorphic transformation during the extrusion-granulation process on the pharmaceutical properties of carbamazepine granules. *Chem Pharm Bull* 1997; 45(5):894–898.
28. Yu L. Amorphous pharmaceutical solids: preparation, characterization and stabilization. *Adv Drug Delivery Rev* 2001; 48:27–42.
29. Kawashima Y. Solubility and dissolution rate. Gotoh K, Masuda H, Higashitani K, eds. *Powder Technology Handbook*. New York: Marcel Dekker, 1997:217–230.
30. Cavallari C, Abertini B, González-Rodríguez ML, Rodríguez L. Improved dissolution behaviour of steam-granulated piroxicam. *Eur J Pharm Biopharm* 2002; 54:65–73.
31. Uekama K, Ikegami K, Wang Z, Horiuchi Y, Hirayama F. Inhibitory effect of 2-hydroxypropyl- $\beta$ -cyclodextrin on crystal-growth of nifedipine during storage: superior dissolution and oral bioavailability compared with polyvinylpyrrolidone K-30. *J Pharm Pharmacol* 1992; 44:73–78.
32. Ekenved G, Elofsson R, Solvell L. Bioavailability studies on a buffered acetylsalicylic acid preparation. *Acta Pharm Suecica* 1975; 12:323–332.
33. Mason WD, Winer N. Kinetics of aspirin, salicylic acid, and salicylic acid following oral administration of aspirin as a tablet and two buffered solutions. *J Pharm Sci* 1981; 70(3):262–265.
34. Mason WD, Winer N. Influence of food on aspirin absorption from tablets and buffered solutions. *J Pharm Sci* 1983; 72(7):819–821.
35. Wang Z, Hirayama F, Ikegami K, Uekama K. Release characteristics of nifedipine from 2-hydroxypropyl- $\beta$ -cyclodextrin complex during storage and its modification of hybridizing polyvinylpyrrolidone K-30. *Chem Pharm Bull* 1993; 41(10):1822–1826.
36. Gordon MS. Process considerations in reducing tablet friability and their effect on in vitro dissolution. *Drug Dev Ind Pharm* 1994; 20(1):11–29.
37. Ghosh LK, Ghosh NC, Chatterjee M, Gupta BK. Product development studies on the tablet formulation of ibuprofen to improve bioavailability. *Drug Dev Ind Pharm* 1998; 29(3):299–310.
38. Gohel MC, Patel LD. Processing of nimesulide-PEG 400-PG-PVP solid dispersions: preparation, characterization, and in vitro dissolution. *Drug Dev Ind Pharm* 2003; 29(3):299–310.
39. Sjökvist E, Nyström C, Aldén M. Physicochemical aspects of drug release XIII. The effect of sodium dodecyl sulphate additions on the structure and dissolution of a drug in solid dispersions. *Int J Pharm* 1991; 69:53–62.
40. Mitchell SA, Reynolds TD, Dasbach TP. A compaction process to enhance dissolution of poorly water-soluble drugs using hydroxypropyl methylcellulose. *Int J Pharm* 2003; 250:3–11.
41. Vervaet C, Baert L, Remon JP. Enhancement of in vitro release by using polyethylene glycol 400 and PEG-40 hydrogenated castor oil in pellets made by extrusion/spherulization. *Int J Pharm* 1994; 108:207–212.

42. Mehta KA, Kislalioglu MS, Phuapradit W, Malick AW, Shah NH. Multi-unit controlled release systems of nifedipine and nifedipine:Pluronic® F-68 solid dispersions: characterization of release mechanisms. *Drug Dev Ind Pharm* 2002; 28(3):275–285.
43. Storey DE. The role of dissolution testing in the design of immediate release dosage forms. *Drug Inf J* 1996; 30:1039–1044.
44. Gordon MS, Rudraraju VS, Rhie JK, Chowhan ZT. The effect of aging on the dissolution of wet granulated tablets containing super disintegrants. *Int J Pharm* 1993; 97:119–131.
45. Bolhuis GK, Zuurman K, Wierik GHP. Improvement of dissolution of poorly soluble drugs by solid deposition on a super disintegrant II. The choice of super disintegrants and effect of granulation. *Eur J Pharm Sci* 1997; 5:63–69.
46. Perissutti B, Rubessa F, Moneghini M, Voinovich D. Formulation design of carbamazepine fast-release tablets prepared by melt granulation technique. *Int J Pharm* 2003; 256:53–63.
47. Levy G, Antkowiak J, Procknal J, White D. Effect of certain tablet formulation factors on dissolution rate of the active ingredient II: granule size, starch concentration, and compression pressure. *J Pharm Sci* 1963; 52(11):1047–1051.
48. Gao JZH, Jain A, Motheram R, Gray DB, Hussain MA. Fluid bed granulation of a poorly water soluble, low density, micronized drug: comparison with high shear granulation. *Int J Pharm* 2002; 237:1–14.
49. Räsänen E, Rantanen J, Jørgensen A, Karjalainen M, Paakkari T, Yliruusi J. Novel identification of pseudopolymorphic changes of theophylline during wet granulation using near infrared spectroscopy. *J Pharm Sci* 2001; 90(3):389–396.
50. Jørgensen A, Rantanen J, Karjalainen M, Khriachtchev L, Räsänen E, Yliruusi J. Hydrate formation during wet granulation studied by spectroscopic methods and multivariate analysis. *Pharm Res* 2002; 19(9):1285–1291.
51. Airaksinen S, Luukkonen P, Jørgensen A, Karjalainen M, Rantanen J, Yliruusi J. Effects of excipients on hydrate formation in wet masses containing theophylline. *J Pharm Sci* 2003; 92(3):516–528.
52. Phadnis N, Suryanarayanan R. Polymorphism in anhydrous theophylline-implications on the dissolution rate of theophylline tablets. *J Pharm Sci* 1997; 86(11):1256–1263.
53. Bansal P, Haribhakti K, Subramanian V, Plakogiannis F. Effect of formulation and process variables on the dissolution profile of naproxen sodium from tablets. *Drug Dev Ind Pharm* 1994; 20(3):2151–2156.
54. Wu P, Attarchi F, Anderson N, Carstensen JT. Effect of drug solubility in wet granulation fluids on the dissolution rates of the resulting tablets. *Drug Dev Ind Pharm* 1989; 15(1):11–16.
55. Chowhan ZT, Amaro AA. Optimization of tablet friability, maximum attainable crushing strength, weight variation and in vitro dissolution by establishing in-process variable controls. *Drug Dev Ind Pharm* 1988; 14(4):1079–1106.
56. Chowhan ZT, Yang IC, Amaro AA, Chi LH. Effect of moisture and crushing strength on tablet friability and in vitro dissolution. *J Pharm Sci* 1982; 71(12):1371–1375.
57. Zhang G, Schwartz JB, Schnaare RL. Effect of spheronization technique on drug release from uncoated beads. *Drug Dev Ind Pharm* 1990; 16(7):1171–1184.
58. Chowhan ZT. Moisture, hardness, disintegration and dissolution interrelationships in compressed tablets prepared by the wet granulation process. *Drug Dev Ind Pharm* 1979; 5:41–62.
59. Ertel KD, Zoglio MA, Ritschel WA, Carstensen JT. Physical aspects of wet granulation IV-effect of kneading time on dissolution rate and tablet properties. *Drug Dev Ind Pharm* 1990; 16(6):963–981.
60. Otsuka M, Gao J, Matsuda Y. Effects of mixer and mixing time on the pharmaceutical properties of theophylline tablets containing various kinds of lactose as diluents. *Drug Dev Ind Pharm* 1993; 19(3):333–348.

61. Chiou WL, Riegelman S. Pharmaceutical applications of solid dispersion systems. *J Pharm Sci* 1971; 60(9):1281–1302.
62. Broman E, Khoo C, Taylor LS. A comparison of alternative polymer excipients and processing methods for making solid dispersions of a poorly water soluble drug. *Int J Pharm* 2002; 222:139–151.
63. Vervaeet C, Remon JP. Bioavailability of hydrochlorothiazide from pellets, made by extrusion/spheronisation, containing polyethylene glycol 400 as a dissolution enhancer. *Pharm Res* 1997; 14(11):1644–1646.
64. El-Egakey MA, Soliva M, Speiser P. Hot extruded dosage forms, part I technology and dissolution kinetics of polymeric matrices P. *Pharm Acta Helv* 1971; 46:31–52.
65. Hülsmann S, Backensfeld T, Keitel S, Bodmeier R. Melt extrusion—an alternative method for enhancing the dissolution rate of 17 $\beta$ -estradiol hemihydrate. *Eur J Pharm Biopharm* 2000; 49:237–242.
66. Forster A, Hempenstall J, Rades T. Characterization of glass solutions of poorly water-soluble drugs produced by melt extrusion with hydrophilic amorphous polymers. *J Pharm Pharmacol* 2001; 53:303–315.
67. Perissutti B, Newton JM, Podczcek F, Rubessa F. Preparation of extruded carbamazepine and PEG 4000 as potential rapid release dosage form. *Eur J Pharm Biopharm* 2002; 53:125–132.
68. Ndindayino F, Vervaeet C, Van Den Mooter G, Remon JP. Bioavailability of hydrochlorothiazide from isomalt-based moulded tablets. *Int J Pharm* 2002; 246:199–202.
69. Dittgen M, Fricke S, Gerecke H, Osterwald H. Hot spin mixing—a new technology to manufacture solid dispersions, part I: testosterone. *Pharmazie* 1995; 50:225–226.
70. Ford JL, Rubinstein MH. Formulation and ageing of tablets prepared from indomethacin-polyethylene glycol 6000 solid dispersions. *Pharm Acta Helv* 1980; 55(1):1–7.
71. Kinget R, Kemel R. Preparation and properties of granulates containing solid dispersions. *Acta Pharm Technol* 1985; 31(2):57–62.
72. Passerini N, Albertini B, González-Rodríguez ML, Cavallari C, Rodriguez L. Preparation and characterization of ibuprofen-poloxamer 188 granules obtained by melt granulation. *Eur J Pharm Sci* 2002; 15:71–78.
73. Gupta MK, Goldman D, Bogner RH, Tseng YC. Enhanced drug dissolution and bulk properties of solid dispersions granulated with a surface adsorbent. *Pharm Dev Technol* 2001; 6(4):563–572.
74. Gupta MK, Bogner RH, Goldman D, Tseng YC. Mechanism for further enhancement in drug dissolution from solid-dispersion granules upon storage. *Pharm Dev Technol* 2002; 7(1):103–112.
75. Gupta MK, Tseng YC, Goldman D, Bogner RH. Hydrogen bonding with adsorbent during storage governs drug dissolution from solid-dispersion granules. *Pharm Res* 2002; 19(11):1663–1672.
76. Nozawa Y, Mizumoto T, Higashide F. Improving dissolution rates of practically insoluble drug phenytoin by roll mixing with polyvinyl pyrrolidone. *Pharm Acta Helv* 1985; 60(5,6):175–177.
77. Nozawa Y, Mizumoto T, Higashide F. Increases in dissolution rate of nifedipine by roll mixing with polyvinyl pyrrolidone. *Pharm Acta Helv* 1986; 61(12):337–341.
78. Fini A, Rodriguez , Cavallari C, Albertini C, Passerini N. Ultrasound-compacted and spray-congealed indomethacin/polyethyleneglycol systems. *Int J Pharm* 2002; 247: 11–22.
79. Passerini N, Perissutti B, Moneghini M, Voinovich D, Albertini B, Cavallari C, Rodriguez L. Characterization of carbamazepine-gelucire 50/13 microparticles prepared by a spray congealing process using ultrasounds. *J Pharm Sci* 2002; 91(3):699–707.
80. Corveleyn S, Remon JP. Formulation and production of rapidly disintegrating tablets by lyophilisation using hydrochlorothiazide as a model drug. *Int J Pharm* 1997; 152:215–225.

81. Corveleyn S, Remon JP. Formulation of a lyophilized dry emulsion tablet for the delivery of poorly soluble drugs. *Int J Pharm* 1998; 166:65–74.
82. Corveleyn S, Remon JP. Bioavailability of hydrochlorothiazide: conventional versus freeze-dried tablets. *Int J Pharm* 1998; 173:149–155.
83. Kim KH, Jarowski CI. Surface tension lowering and dissolution rate of hydrocortisone from solid solutions of selected *n*-acyl esters of cholesterol. *J Pharm Sci* 1977; 66(11):1536–1540.
84. Deasy PB, Gouldson MP. In vitro evaluation of pellets containing enteric coprecipitates of nifedipine formed by non-aqueous spherization. *Int J Pharm* 1996; 132:131–141.
85. Corrigan OI, Holohan EM. Amorphous spray-dried hydroflumethiazide-polyvinylpyrrolidone systems: physicochemical properties. *J Pharm Pharmacol* 1984; 36:217–221.
86. Arias MJ, Ginés JM, Moyano JR, Pérez-Martínez JI, Rabasco AM. Influence of the preparation method of solid dispersions on their dissolution rate: study of triamterene-D-mannitol system. *Int J Pharm* 1995; 123:25–31.
87. Hu J, Rogers TL, Brown J, Young T, Johnston KP, Williams RO. Improvement of dissolution rates of poorly water soluble APIs using novel spray freezing into liquid technology. *Pharm Res* 2002; 19(9):1278–1284.
88. Rogers TL, Nelsen AC, Hu J, Brown JN, Sarkari M, Young TJ, Johnston KP, Williams RO. A novel particle engineering technology to enhance dissolution of poorly water soluble drugs: spray-freezing into liquid. *Eur J Pharm Biopharm* 2002; 54:271–280.
89. Rogers TL, Hu J, Yu Z, Johnston KP, Williams RO. A novel particle engineering technology: spray-freezing into liquid. *Int J Pharm* 2002; 242:93–100.
90. Rogers TL, Johnston KP, Williams RO. Physical stability of micronized powders produced by spray-freezing into liquid (SFL) to enhance the dissolution of an insoluble drug. *Pharm Dev Technol* 2003; 8(2):187–197.
91. Rogers TL, Johnston KP, Williams RO. Enhanced aqueous dissolution of a poorly water soluble drug by novel particle engineering technology: spray-freezing into liquid with atmospheric freeze-drying. *Pharm Res* 2003; 20(3):485–493.
92. Rodríguez L, Cavallari C, Passerini N, Albertini B, González-Rodríguez ML, Fini A. Preparation and characterization by morphological analysis of diclofenac/PEG 4000 granules obtained using three different techniques. *Int. J Pharm* 2002; 242(1,2):285–289.
93. Senčar-Božič P, Srčič S, Knez Ž, Kerč J. Improvement of nifedipine dissolution characteristics using supercritical CO<sub>2</sub>. *Int J Pharm* 1997; 148:123–130.
94. Moneghini M, Kikic I, Voinovich D, Perissutti B, Filipović-Grčić J. Processing of carbamazepine-PEG 4000 solid dispersions with supercritical carbon dioxide: preparation, characterisation, and in vitro dissolution. *Int J Pharm* 2001; 222:129–138.
95. Corrigan OI, Crean AM. Comparative physicochemical properties of hydrocortisone-PVP composites prepared using supercritical carbon dioxide by the GAS anti-solvent recrystallization process by coprecipitation and by spray drying. *Int J Pharm* 2002; 245:75–82.
96. Ford JL. The current status of solid dispersions. *Pharm Acta Helv* 1986; 61(3):69–88.
97. Serajuddin ATM. Solid dispersion of poorly water-soluble drugs: early promises, subsequent problems, and recent breakthroughs. *J Pharm Sci* 1999; 88(10):1058–1066.
98. Leuner C, Dressman J. Improving drug solubility for oral delivery using solid dispersions. *Eur J Pharm Biopharm* 2000; 50:47–60.
99. Sekiguchi K, Obi N. Studies on absorption of eutectic mixture I. A comparison of the behavior of eutectic mixture of sulfathiazole and that of ordinary sulfathiazole in man. *Chem Pharm Bull* 1961; 9:866–872.
100. Tachibana T, Nakamura A. A method for preparing an aqueous colloidal dispersion of organic materials by using water-soluble polymers: dispersion of beta-carotene by polyvinylpyrrolidone. *Koll Z Polym* 1965; 203:130–133.
101. Bates TR. Dissolution characteristics of reserpine-polyvinylpyrrolidone co-precipitates. *J Pharm Pharmacol* 1969; 21:710–712.

102. Breitenbach J. Melt extrusion: from process to drug delivery technology. *Eur J Pharm Biopharm* 2002; 54:107–117.
103. Virley P, Yarwood R. Zydis—a novel, fast dissolving dosage form. *Manuf Chem* 1990; 61(2):36–37.
104. Seager H. Drug-delivery products and the Zydis fast-dissolving dosage form. *J Pharm Pharmacol* 1998; 50:375–382.
105. Thapa P, Baillie AJ, Stevens HNE. Lyophilization of unit dose pharmaceutical dosage forms. *Drug Dev Ind Pharm* 2003; 29(5):595–602.

# 15

## Continuous Granulation Technologies

**Rudolf Schroeder\***

*L.B. Bohle Maschinen und Verfahren GmbH, Ennigerloh, Germany*

**Klaus-Jürgen Steffens**

*Department of Pharmaceutical Technology, University of Bonn, Bonn, Germany*

### 1. INTRODUCTION

Granulation of powders is a well-known process in the pharmaceutical industry where primary particles are made to adhere in order to form larger entities called granules. Primarily, it is used for an improvement of the flow characteristics as well as for assuring the homogeneity and mechanical stability of the blend during further production steps. Especially for the compaction of modern actives, granulation is often unavoidable due to the hydrophobic characteristics of these substances. By binder granulation the actives are “coated” with a hydrophilic agent, thus establishing electrostatic interactions between the granulate particles and enabling water to penetrate the tablet in order to improve disintegration and dissolution behavior.

Also, the granulation process can be used to influence the dissolution behavior of a tablet, e.g., to gain a drug with sustained release characteristics. In this case melt agglomeration by hot melt extrusion is a widespread process where a particular excipient is able to melt and mechanically stabilizes the agglomerates after cooling (1,2). This excipient embeds the active components in a so-called “matrix” and alters the dissolution characteristics from immediate release to a diffusion controlled sustained release.

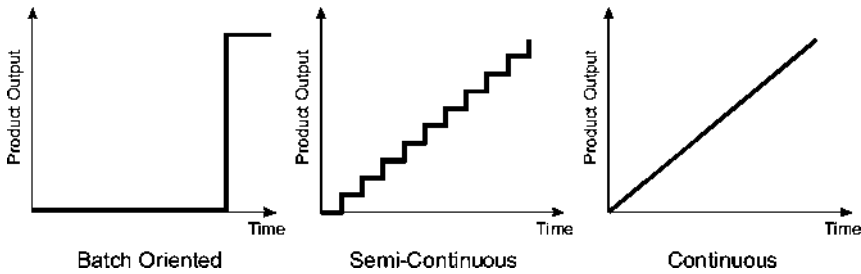
### 2. COMPARISON OF DIFFERENT MODES OF PROCESSING

To be able to compare the different modes of operation like continuous, semicontinuous, and batch oriented processing it is necessary to define them and to delimit from each other. A first distinction can be made by the product output per time (Fig. 1).

In the case of batch oriented processing the total product volume  $M$  is released after the process duration  $T$  whereas for (semi) continuous processing the product output occurs gradually. The semicontinuous process arises from the division of the total

---

\* *Present Address:* Abbott GmbH & Co. KG, Ludwigshafen, Germany.



**Figure 1** Product output for batch oriented, semicontinuous, and continuous processing.

batch size  $M$  into a defined number  $n$  of subbatches. The quotient of subbatch size  $m_S$  and the process time for one particular subbatch  $t_S$  is constant for every subbatch.

For really continuous processes neither the total batch size nor a subbatch size is given by itself. Consecutively, the batch size  $M$  is a result of the product output  $m_C$  per time  $t_C$ . The quotient of  $m_C$  and  $t_C$  is constant and the product output is proportional to the production time. The mathematical descriptions are displayed in Table 1. Arising from these circumstances some consequences are given, resulting in both advantages and disadvantages in terms of process control.

For batch oriented processing always a large amount of raw materials is being granulated; thus, it is quite stable against small deviations of single components in terms of weighing. Furthermore, it is possible to equalize these deviations by adapting the process control or the total process duration. Therefore, an oos result due to these reasons is very unlikely. In the case of continuous processing it is absolutely unavoidable to carry out the subprocesses in a continuous way and to ensure that the speed of the subprocess is proportional to the process speed. Otherwise, deviations in product properties are inescapable. In most cases a correction and thereby compensation of these deviations is not possible.

The semicontinuous processing takes an intermediate position. On the one hand, small deviations can be tolerated and equalized; on the other hand, the homogeneity from one subbatch to another has to be ensured to guarantee the homogeneity of the whole batch. From the latter point of view the semicontinuous processes are better comparable to the batch oriented than to the continuous ones.

For pharmaceutical purposes the product properties can be ensured with the IPC correlating to the needs of the process. Furthermore, the results of the in-process control (IPC) can be used to influence the process control if speaking of batch oriented or semicontinuous processing. In the case of continuous processing one will take care of a robust process control to avoid alterations to a maximum during the

**Table 1** Mathematical Descriptions of the Different Types of Processing

	Batch oriented	Semicontinuous	Continuous
Batch size	$M$	$M = nm_S$ ( $n = 0, 1, 2, \dots$ )	$M = T \left( \frac{m_C}{t_C} \right) = T \left( \frac{dm}{dt} \right)$ while $dm/dt = \text{constant}$
Process duration	$T$	$T = nt_S$	$T = M \left( \frac{dm}{dt} \right)^{-1}$

Note: For variables, see text.



process. Measurement of the process parameters should be for documentation only, for instance, to show the homogeneity.

The transfer of a process from one machine to another and the simultaneous increase of the batch size while keeping the product properties, the so-called “scaling-up,” is a challenge in the pharmaceutical industry where most granulation processes are batch oriented.

For instance in a high-shear granulator the product properties are influenced by the alteration in the geometry of the bowl and the speed and shape of the impeller as well as the not negligible influence of material load. The occurring deviations have to be compensated with alterations in the process control.

This problem does not occur in continuous processing because the batch size can be adjusted by the process time without interfering in the process control. For semicontinuous processes the batch size can be adjusted by the number of subbatches resulting in identical opportunities as for continuous processes. This approach is limited due to economic aspects with respect to the duration of the whole process, also taking into account preceding or following process steps.

The transfer of a batch oriented process to a semicontinuous one is possible by a repetition of the process and a narrow linking of the subprocesses. The homogeneity and thereby the quality of the product can be stated if the process is always running under the same conditions. This also includes the cleanliness of the machine with regard to material buildup arising from the former subbatches. For really continuous processes this procedure is not possible in most cases.

One big advantage of continuous processing arises from the demand for a precise and stable process control. Hereby, the IPC can be reduced and the surveillance of the process can be reduced. Therefore, continuous processes have a reduced need for control after reaching steady-state conditions (Fig. 18). Roller compaction described in another chapter of this book is also a good example of a continuous granulation technique.

### 3. FLUID BED SYSTEMS

Today there are a large number of suppliers manufacturing continuously working fluid bed systems for drying and granulation. But as the origin of these systems does not lie in the pharmaceutical industry, few companies only designed and manufactured units corresponding to the cGMP standards.

#### 3.1. Process Steps

Along with the traditional batch oriented fluid bed systems also a continuously working machine has to perform the following steps to produce satisfying granules:

1. Product feeding
2. Product preheating and mixing
3. Granulation (spraying)
4. Drying
5. Cooling
6. Discharging

But in contrast to the batch oriented processes in this case the subprocesses are to be carried out in a continuous way conjunct with all advantages and risks mentioned in [Chapter 2](#). The zones are not necessarily mechanically and spatially separated from each other as the following explanations will show.

### 3.2. Single-Cell Systems

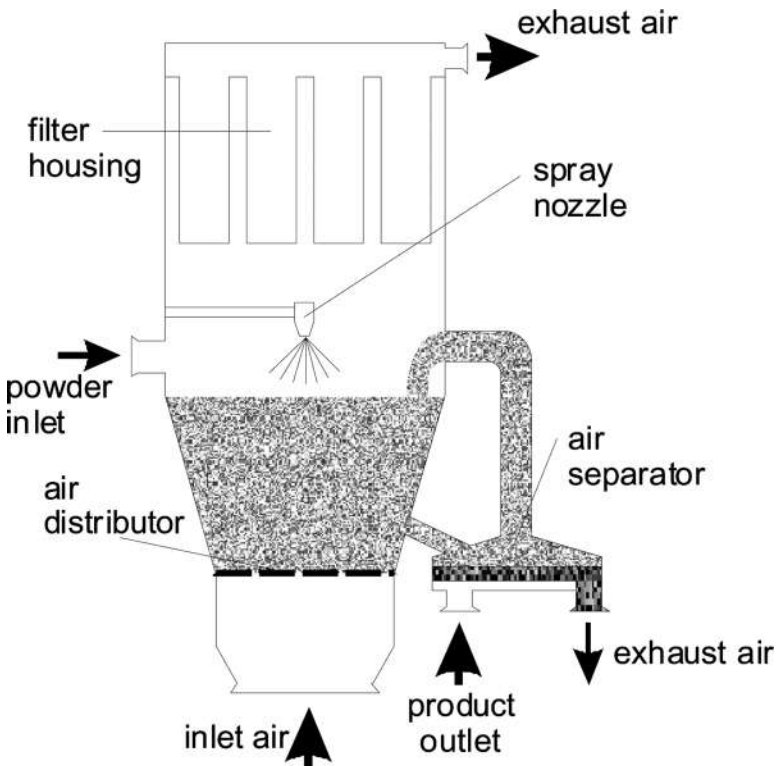
The first investigations for realizing continuous fluid bed systems in the pharmaceutical industry were made by adapting batch oriented fluid bed units. The machines had to be modified to allow continuous powder feeding and product reception (Fig. 2). The feeding unit could be carried out using a rotary valve. Instead of a standard product outlet the continuously working fluid bed is equipped with an air separator to lead back the fine powders into the granulation area.

One major problem of single-cell fluid beds is the fact that all subprocesses of a granulation process have to take place in one reaction chamber. This means the wetted powders for granulation and the dried granules are colocated in the same physical room and can interfere with each other.

To avoid the simultaneous presence of these conflicting process steps multicell systems were developed allowing a segregation and separation of the wet process steps from the dry ones.

### 3.3. MultiCell Systems

With respect to the individual features of every multicell system the general arrangement of the common aspects like air handling, product treatment, feeding, and discharging is quite similar. Therefore, the following paragraphs will give a short overview on the functional basics. Special properties of some exemplary systems will be discussed later in this text.



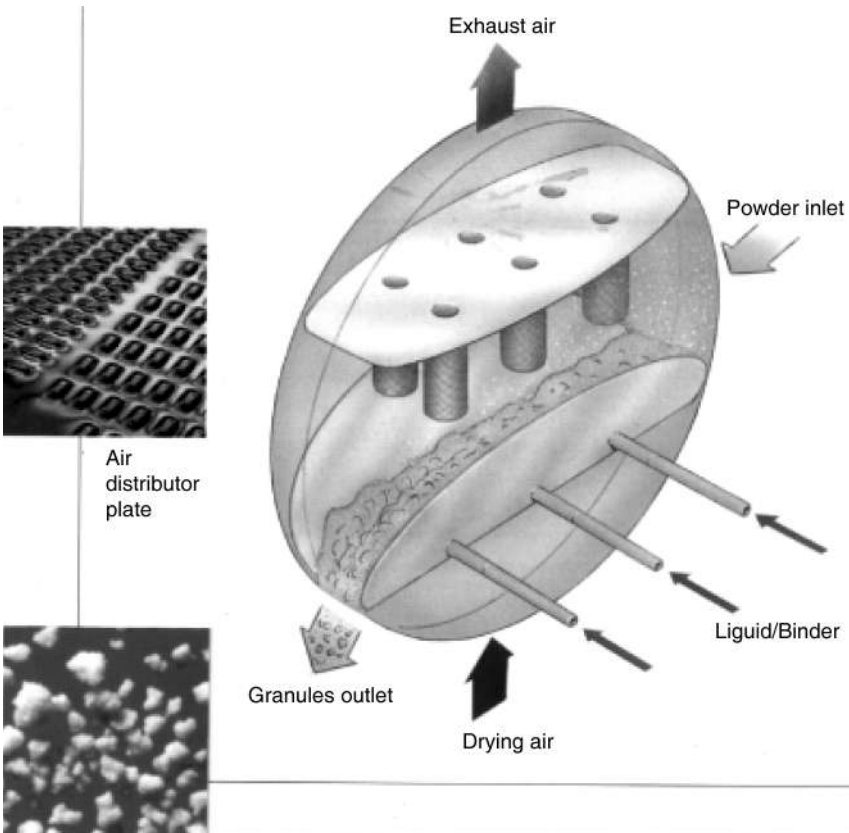
**Figure 2** Single-cell fluid bed processor.

3.3.1. Air Handling and Product Flow

As the course of the inlet air conditions during a batch oriented fluid bed process is not constant, the air supply of a continuous fluid bed is segmented to allow differentiated air temperatures and humidity. Usually, the number of air chambers is equal to or more than the number of process steps of a standard fluid bed process.

The boundary between inlet air supply and product chamber is the air distribution plate. Often this plate is carried out as a gill-plate (Fig. 3). Because of the structure of the plate directed air jets give a forward transport of the product. But this only affects the lowest layer of the powder bed. Above, the air stream is scattered by the powder particles and directed upwards. Therefore, back-mixing occurs and the flow of the product is more or less based on statistical distributions. Without any interior fixtures like baffles or walls the particle flow can be expressed with Bateman's function (3). Thus, the forwarding of the material is a result of the incoming raw materials. The main advantages of the gill structure are to be seen in the emptying of the machine—as the final residue of product is affected by the jets—and the improved cleaning facilities compared to a flat plate.

The product flow can be improved by vibration or by a sloping arrangement of the air distribution plate from the in-feed toward the product discharge. The latter leads to a voluntary flow of the particles taking advantage of the liquid-like behavior of fluidized powders.



**Figure 3** Niro Contipharm™. (Courtesy of Niro Pharma Systems, Muellheim, Germany.)

The most important aspect of the product flow is a homogenous transport throughout the whole process without segregation of powder particles. Furthermore, it has to be ensured that fine powders can be moved as well as larger agglomerates (lumps). Consequently, the sloped design is to be seen as less favorable as it can result in a nonhomogenous product flow.

The upper boundary of the product chamber is given by a set of filter cartridges whereas the specific design follows up different purposes like particle separation and usability for CIP (cleaning in place). In the latter case the filter cartridges are usually made of stainless steel.

### 3.3.2. *Spray Nozzle Arrangement*

Like in batch oriented fluid bed processors the spray nozzles can be arranged either as top-spray or bottom-spray. For blends that can be hardly granulated, typically bottom-spray arrangements are preferred to take advantage of local overwettings.

### 3.3.3. *Feeding and Discharging*

Prior to the steady-state phase of the production usually the bed has to be filled to a certain level, that is, mainly depending on the design of the equipment and the pressure drop over the bed. The constancy of the bed height can also be ensured via the pressure drop. Therefore, this value is important for the control of the powder feed and product discharge.

### 3.3.4. *Continuous Fluid Bed Processor: Niro Contipharm<sup>TM</sup>*

The product chamber is of a round shape with a diameter of  $\approx 2$  m (Fig. 3). The rear boundary is fixed to the wall and carried out as a torospherical head. The front boundary of identical shape can be moved hydraulically to open the product chamber for inspection and cleaning.

The interior between the dished disks is divided horizontally into three sections. The first section from bottom to top is the inlet air section consisting of three subdivisions separated from each other by vertical walls. This allows adjusting the inlet air conditions for preblending, granulation, and drying corresponding to the product characteristics and process requirements independently. The upper boundary of the inlet air chamber is given by the air distributor plate carried out as a groove-like gill-plate with a flattened bottom to keep the powders in the middle of the plate. Additionally, it contains a set of two-component nozzles to add the granulation liquid in a bottom-spray arrangement. On the upper end the product chamber is bordered by exhaust air filters made of stainless steel. The whole rig is prepared for CIP.

The product in-feed and discharge are carried out as rotary valves to assure a constant material supply and bed height.

As for most continuous granulation processes the production is divided into three major steps. In the first step the machine is filled with  $\approx 50$  kg of powder. Consecutively, the granulation is started for about 1 hr in a batch-like manner with powder inlet and discharge closed. After the granulation is done the machine is switched to continuous mode with a product throughput of about 160–240 kg/hr. When all materials are processed the production chamber is emptied and automatically cleaned with the integrated CIP unit (4).

### 3.3.5. *Heinen Continuous Fluid Bed Processes*

The basic concept of the Heinen fluidized bed system is based on a sectional structure with separated inlet zones for the drying air (Fig. 4). This means, the drying or fluidizing air is added section by section in multiple, separate temperature and air zones as explained earlier.

Mostly, the air distribution plate is carried out as a rectangular gill-plate to ensure the forwarding of the product, supported by integrated pneumatic vibrators. Consecutively, it passes the different zones of the granulation process (Fig. 5).

The granulation, drying and cooling zones are physically separated from each other by vertical walls while the orifice between granulation and drying is permanently open and the cooling chamber can be closed by controllable valves. This should give a more efficient heat exchange and reduced back mixing of the dried granules into the wetting area. Furthermore, it reduces the heat exchange between the hot inlet air for drying and the cold air for cooling.

Usually, the spray nozzles are arranged in top-spray orientation. With the integrated cleaning nozzles the complete rig is prepared for CIP (Fig. 6).

Because this results in a compact system it is possible to implement widely differing process steps and temperature sequences adapted to the specific product. This provides a variety of options for setting and optimizing process parameters.

## 4. MECHANICAL WET GRANULATION SYSTEMS

The variety of mechanical granulation systems is very highly justified with the manifold requirements of the formulations on the market. The various system available on the



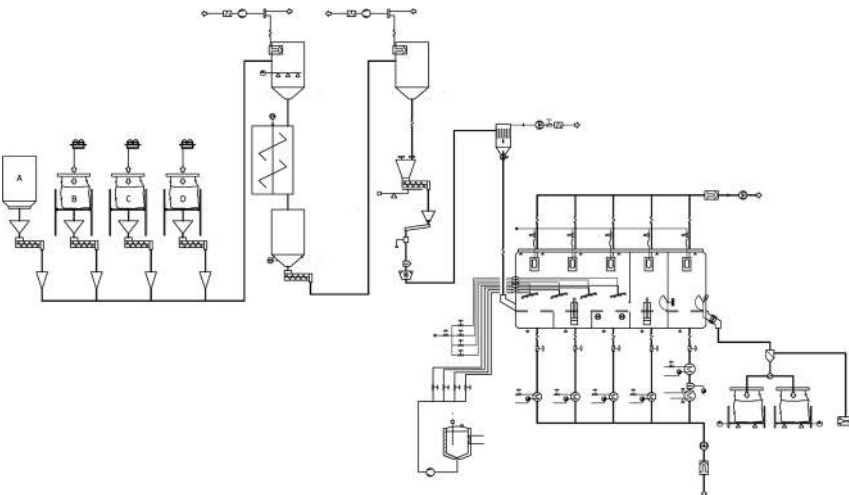
**Figure 4** Heinen continuous fluid bed processor. (Courtesy of Heinen Trocknungstechnologie GmbH, Varel, Germany.)



**Figure 5** Continuous fluid bed processor during operation. (Courtesy of Heinen Trocknungstechnologie GmbH, Varel, Germany.)

market can be differentiated and classified by means of several parameters as product holding times, energy input, product loss and product hold-up, respectively.

Product holding time or dwell time and energy input cannot be seen as separated from each other. Only the combination of both enables a prediction of the granulation characteristics of the machine. Especially in the case of hardly soluble substances or raw materials with a need for intensive blending either a high holding



**Figure 6** Exemplary PI-diagram of a granulation process. (Courtesy of Heinen Trocknungstechnologie GmbH, Varel, Germany.)

time combined with an average energy input or a low holding time together with high energy input can lead to satisfying granules.

Product holdup (product staying inside the machine after granulation) is of importance during the drug development phase as it limits the minimum batch size possible. The larger the batch size the less important is the product holdup of the machine as it is a constant value independent of the total batch size. Nevertheless, a low product holdup helps in reducing waste and thus helps in cleaning.

A lot of mechanical continuous granulation equipment can be seen as derived from single- or twin-screw extrusion systems, mostly improved with special fixtures inside like choppers or baffles to fulfill the needs of pharmaceutical wet granulation processes. Screw extrusion systems are treated elsewhere in this book and will not be discussed at this point.

Other machines like the Schugi mixer–agglomerator (Hosokawa Schugi B.V., Lelystad, The Netherlands) or the Nica M6 turbine mixer and granulator (Aero-matic-Fielder Ltd., Eastleigh, U.K.) were already mentioned and discussed in the last edition of this book.

#### 4.1. Semicontinuous Processing: Glatt Multicell™

This machine takes an intermediate position between fluid bed systems and mechanical granulation equipment (Fig. 7). The philosophy this machine is based on, is the size reduction of the manufacturing equipment combined with the tight conjunction of the single subprocesses (containing product loads addressed as subunits) while each subprocess is located in a separate process chamber, in order to reduce scale-up efforts. From raw material to dried granules the product passes through the following stages:

1. Weighing system for raw materials
2. Wet granulation by small-scale plough-share blender and simultaneous injection of granulation liquid
3. Milling of the wet granules via a rotary sieve machine
4. Predrying, final drying, and cooling in a three-chambered fluid bed dryer
5. Final milling in a second rotary sieve machine

All process chambers are linked by tubes for contained product transfer. The transfer itself is realized pneumatically by airflow (5).

The minimum subunit size depends on the minimum capacity of the plough-share blender. The manufacturer specifies 1–25 kg/subunit as acceptable range, covered by three different sizes of equipment. The throughput depends on the process and properties of the raw material. But as the system should be able to run unattended in a semi-continuous way the real throughput is less important if economic aspects are not taken care of.

The machine is prepared for automated CIP with approx. 40 cleaning nozzles installed.

#### 4.2. High-Throughput Mixer–Granulator: Lödige Ploughshare® Mixers

The main elements of the plough-share blender are a horizontal drum and granulation chamber and a horizontally rotating shaft, equipped with different transporting and blending elements, the shovels (Fig. 8). Usually, the arrangement of the shovels



**Figure 7** Multicell semicontinuous granulation processor. The dosing processor and granulation unit can be seen on the left side. (Courtesy of Glatt GmbH, Binzen, Germany.)

gives a three-segmented process. The first part of the axle is equipped with a relatively low amount of shovels and mainly acts as a feeding section to preblend the mixture and forward it into the granulation section where the blending elements are carried out as blending sticks. At this point the granulation liquid is added and forwarding of the material is less important than a sufficient power intake. Consecutively, the material is entering the postprocessing section where the granules are formed to their final shape and moved to the discharging orifice.

The revolution speed of the axle is high enough to form a fluid bed-like behavior. Due to the shape of the blending elements and the material characteristics, nearly spherical particles can be obtained. Due to the blending characteristic, a disadvantage of the plough-share blender is the buildup of large agglomerates. High throughputs from 4.5 to 900 m<sup>3</sup>/hr can be achieved (6).

At an even higher revolution speed and slight alterations in the arrangement of the blending elements, high-speed continuous mixers can be achieved (Fig. 9). The flow characteristics of the powder blend inside the machine is very different from plough-share blenders. Due to the high speed of the axle circular layers of material are formed, resulting in higher shearing forces and generally an increased power input. As a result the granules are not as spherical as in plough-share blenders and the particle size distribution is narrower. Thus, the flow characteristic of the





**Figure 8** Continuous plough-share blender. (Courtesy of Gebr. Lödige GmbH, Paderborn, Germany.)

product is worse but the dissolution of the granules is improved even due to the more homogenous blending.

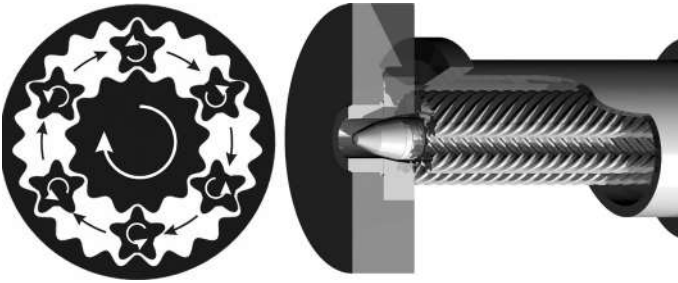
The throughput is comparable to the plough-share blenders and therefore mainly suitable for the production of large batches.

## 5. ROLLER EXTRUSION SYSTEM

As a new system in the pharmaceutical market the function and usability of a roller extrusion system for pharmaceutical wet granulation will be discussed in more detail.



**Figure 9** High-speed continuous mixer. (Courtesy of Gebr. Lödige GmbH, Paderborn, Germany.)



**Figure 10** Appearance of a planetary roller extruder. The arrows on the left side indicate the movements during extrusion.

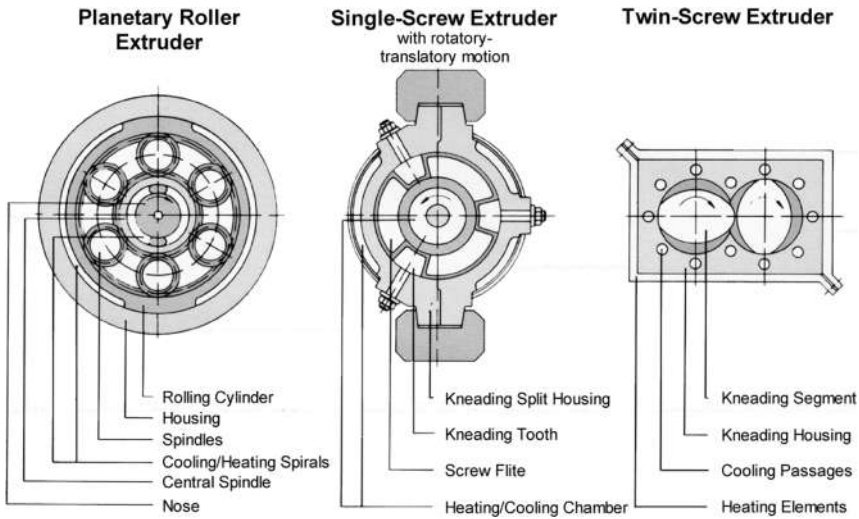
Roller extrusion is a special type of extrusion not comparable to the classical single- or twin-screw extrusion systems. In screw extrusion systems the main part and functional center of the machine is the combination of the screw itself and the barrel as casing for the screw. The different aims like degassing, ventilation, blending, melting, and cooling can be made possible by the screw design—in case of a twin-screw extruder also the cooperation of both intermeshing screws—and the temperature control of the barrel. Usually, there is no temperature control for the screws. To achieve a sufficient forward transport it is necessary to take care that the friction between material and barrel is higher than the friction between material and screw (14).

For roller extruders or planetary roller extruders these explanations are not applicable. The design and shape are very different. The arrangement of the spindles and the barrel as heart of the machine is comparable to a planetary gear but with a helical gearing of  $45^\circ$ . In the center lies the central spindle attached to the main drive. Around it are the planetary spindles floating freely in the plastic mass, varying in length and number while they are covered by the barrel. On rotation of the central spindle the planetary spindles roll on the central spindle and the internally toothed barrel (Fig. 10). The plastic material floating in the gaps between the planetary spindles is rolled on the surface of the central spindle and the barrel in very thin layers. Thus, it is blended on the whole extrusion distance while the friction heat arising from the homogenization is transferred away into the coolant flowing inside the central spindle and the barrel. The forward transport of the material is due to the helical shape of the gearing. It is imaginable that the contact surface area of a planetary roller extruder is very high (Fig. 11). Compared to a twin-screw extruder the area of a planetary extruder is about six times larger (8).

Arising from these considerations the planetary roller extruder seems to be particularly suitable for the wet and melt agglomeration of pharmaceutical powder blends. In the following is described a system for continuous wet granulation based on a planetary extruder and the usage thereof.

### 5.1. System Description

To take advantage of the manifold opportunities of an extrusion system the machine is built up modularly to be more flexible also in terms of process control. Therefore, the subprocesses known from the classical granulation processes as weighing, blending/granulation, drying, and milling are realized as insulated procedures of an integrated process line. In addition to the classical steps a cooling step can be



**Figure 11** Comparison of different extrusion systems.

implemented to enable the manufacturing of granules by hot melt extrusion. The control of these subprocesses is on the one hand separated from each other; on the other hand, all controls are integrated into a centralized control and report system.

The system is available for very different outputs from 2 up to 1,000<sup>o</sup>kg/hr, realized by four different machine sizes only. Due to the continuous processing very different batch sizes can be granulated with one machine size. For instance, in the case of a granulator with a nominal output of 10<sup>o</sup>kg/hr, normally the realizable output is about 2–20<sup>o</sup>kg/hr, leading to batch sizes from 500<sup>o</sup>g in 15<sup>o</sup>min up to 480<sup>o</sup>kg/24 hrs.

### 5.1.1. Feeding

It is to distinguish between feeding of the powder components and—if applicable—the liquid components, e.g., binder solutions.

Powder components are usually added by mass-controlled twin-screw feeders as it is standard in the pharmaceutical industry. But still there are two possible procedures for the weighing the powder components. One begins with the weighing of the whole formulation by hand, followed up by an external blending step and ends with the feeding of the screw feeder with a preblended mixture. The second and more convenient way is the usage of several screw feeders, one for each raw material in order to completely avoid the manual weighing. This can be done for feeding rates of 200<sup>o</sup>g/hr and more. Due to the limited space and the fact that all feeders have to feed into a single tube the number of feeders is limited. Usually, no preblending has to be done due to the excellent blending capabilities of the granulation system.

Depending on the flow properties the raw materials immediately fall into the feed hopper or they are force-fed inside the feeding tube by a screw or agitator of a different shape. Subsequently, the raw materials are taken over by the feed screw of the granulation system and moved into the granulator.

The feeding of the liquid components can be done with various pumps of different outputs and pressures. As a standard a peristaltic pump is used, controlled by a flow meter based on the Coriolis principle. With respect to the requirements of the formulation and process, different types of pumps can be used.

### 5.1.2. Granulation

As mentioned earlier, the granulation is realized through a planetary roller extruder. By the feed screw the material is taken into the granulation section of the planetary system (Fig. 12).

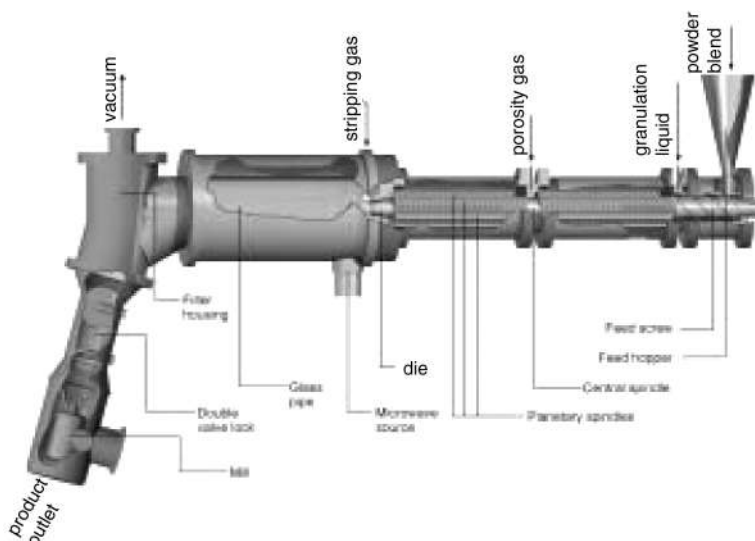
In the case of binder agglomeration the powder components are plasticized by the addition of the binder liquid at the very beginning of the granulation process. Apart from the physical properties of the raw materials the binder liquid is the main plasticizer and lubricant for achieving a viscosity low enough to allow extrusion. The homogeneity and granulation are completed at the end of the first stage of the extruder. There the material has to pass a narrow ring with the function of an intermediate die. Afterward, the mass re-expands and is—if required—blended with nitrogen injected through the middle stop ring in extrusion direction. The gas injection leads to an increase in product porosity and subsequently to a change of product properties as tableting and dissolution behavior. At the product outlet of the granulation unit again the mass is pressed through a die-like ring and brought into shape through a multihole forming unit. If injection of nitrogen is not needed or not wanted, the second stage of the extruder can be removed reducing the extrusion length and energy intake to one-half.

Usually, for melt agglomeration processes the addition of liquids is not necessary because the mass can be plasticized by melting one or more components. The other facts concerning the process are identical to binder agglomerations.

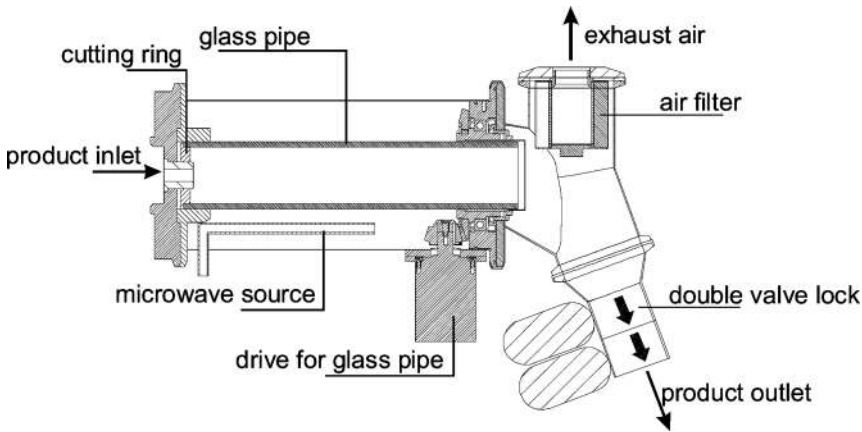
### 5.1.3. Drying

Due to the modular design the drying process can be carried out in different ways. For example, two different types of dryers are described as they are specially adapted to the extrusion/granulation system.

The first one is based on a microwave tube dryer (Figs. 12 and 13). The glass pipe as dryer inlet is flanged to the granulator directly. By the rotation of the glass



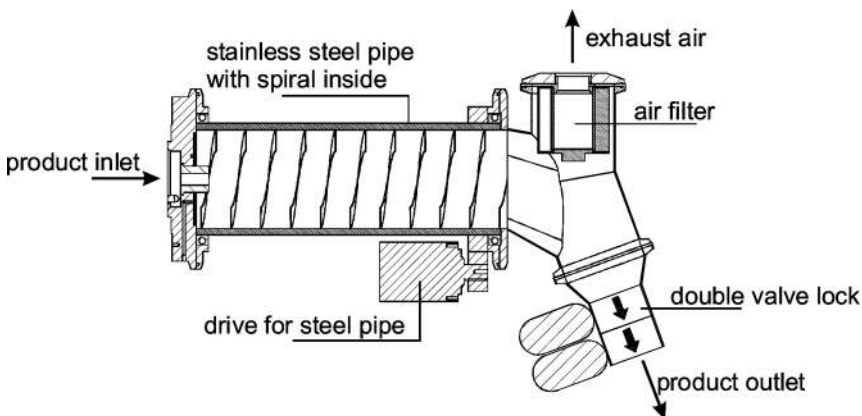
**Figure 12** Overview on granulation process consisting of extruder/granulator, microwave dryer and mill.



**Figure 13** Sectional sketch of a microwave dryer.

pipe the product is cut into cylindrical pieces of  $\approx 0.5\text{--}1\text{ in.}$  in length, the diameter depends on the forming unit of the granulator; usual sizes are  $0.08\text{--}0.2\text{ in.}$  As the sticks fall into the glass pipe they roll due to the round shape. In the same way they are blended and moved forward as an effect of the rotation of the pipe and the following material. The drying is done with low pressure of about  $0.14\text{ psi}$  absolute under microwave radiation and the addition of a stripping gas for improvement of the drying time. To achieve precise drying times barriers can be mounted into the glass pipe (e.g. spirals). The product outlet is carried out as a double-valve lock due to the vacuum inside.

If drying by microwave energy is not possible or not wanted a contact dryer can be used instead (Fig. 14). The design is quite similar to the microwave dryer. Due to the different drying principles the contact dryer has to be larger. The glass pipe is replaced by a stainless steel pipe with a spiral mounted inside. Both the pipe and the spiral can be heated. All additional features for drying improvement like vacuum and stripping gas are implemented.



**Figure 14** Sectional sketch of a contact dryer.

In case the desired dryer is already present the extruder/granulator can be combined with nearly every drying method imaginable.

#### 5.1.4. Cooling

Usually, for melt agglomeration processes no drying is needed. The intermediate product coming out of the extrusion step is warmed up and shows a soft to paste-like behavior. Therefore, milling of the warm product is not possible and a cooling step has to be implemented in between to achieve a brittle consistency that allows milling.

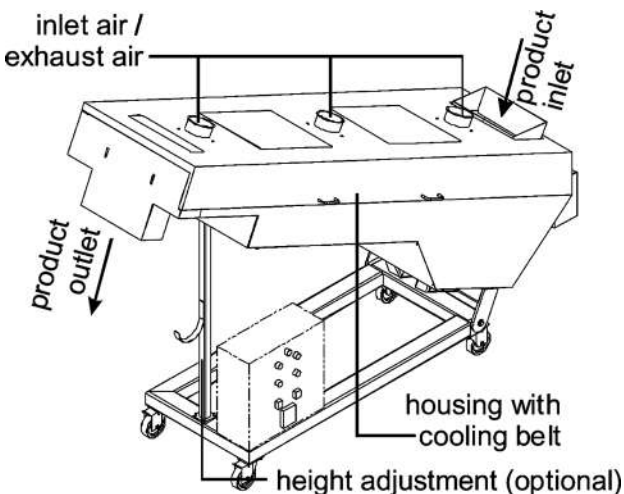
The standard cooling belt is carried out as a stainless steel conveyor while the cooling is done by pharma air (Fig. 15). The belt swings at the entry to deposit the warm product with maximum contact surface. This allows short belts even for high temperature differences between extrudate entry and product outlet.

#### 5.1.5. Milling

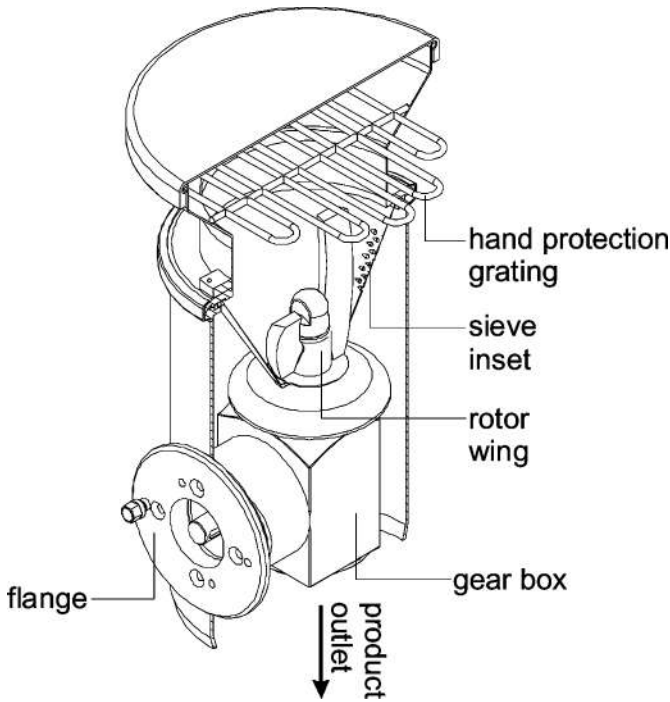
In most processes milling can be done with a standard conical mill (Fig. 16). From the behavior of the material it is to be decided whether to use a flat screen or a rasping screen. The flat screen allows milling with high throughput for brittle substances where a higher amount of fines does not matter. If fines have to be avoided to a maximum or the material to be sieved is very hard or plastic, a rasping mill inset should be used.

#### 5.1.6. Raw Material Supply and Product Reception

To enable constant product flow it is very important to have a look at the material supply and its reception after granulation. The design of the supply chain depends mostly on the process mode. This means in cases of small batches or batches with a volume of not more than one bin the realization is quite easy. With respect to



**Figure 15** Sketch of a cooling belt.



**Figure 16** Sectional sketch of the milling unit.

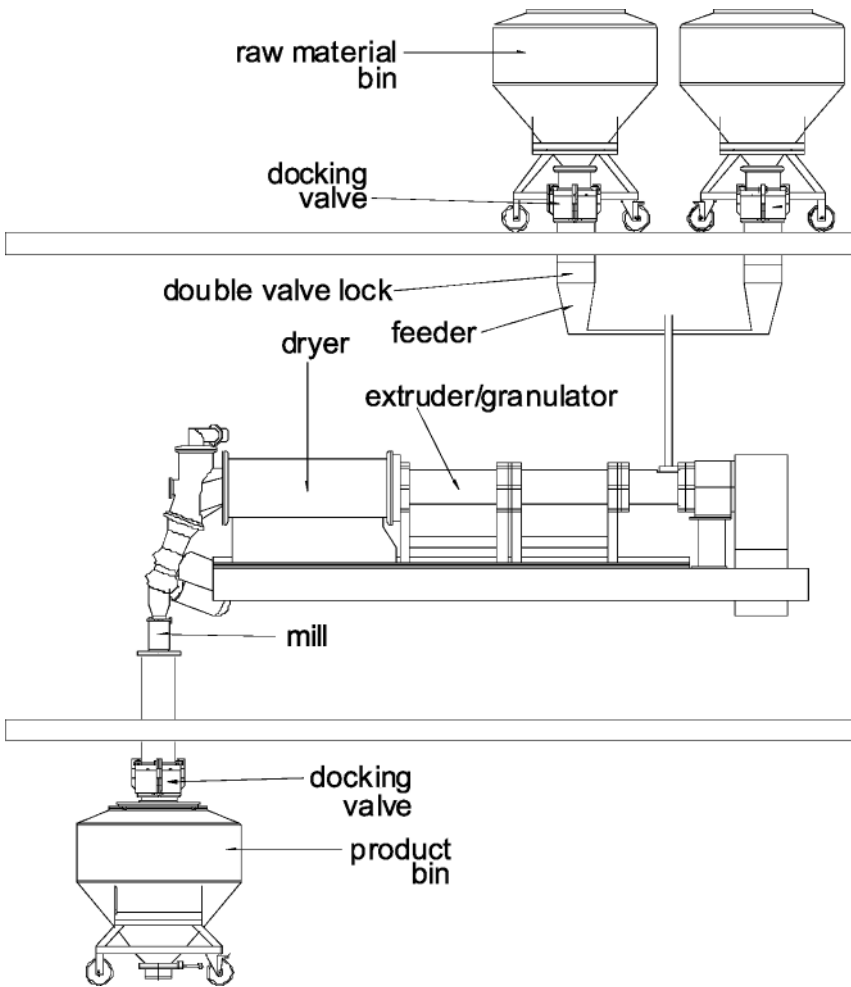
the powder components the raw material bins can be docked onto the feeding unit consisting of the screw feeders themselves and a system for the refill of the feeders. The latter can be realized by a refill screw, for instance. For product reception only one bin is needed that can be docked at the beginning of the process. It is imaginable to connect the further production steps like final blending and tableting immediately instead of a material bin.

If necessary the granulation liquid can be prepared for the whole batch before manufacturing starts.

For continuous processes over days or weeks the arrangement becomes more complex. The bins for the raw materials have to be changed in between creating the need for an intermediate storage of the powders. For establishing this kind of manufacturing the feeding unit is refilled from a small bin. On the other hand the small bins are filled from the raw material bins. This assembly gives a chance to the operators to change the raw material bins in a certain time leading to a constant material flow. The same solution can be used for the granulation liquid.

During the production itself the material handling even of highly potent substances is not critical due to the total encapsulation of the single production steps and the production line as a whole. Therefore, the only locations to take care of are the inlet of the raw material and the product outlet. Consecutively, this means that at every connection designed and qualified for separation during the process a high containment conjunction has to be implemented. With respect to total containment further modifications are not necessary.

**Figure 17** shows the proposal for processing of smaller batches under high containment conditions in a building with three floors.



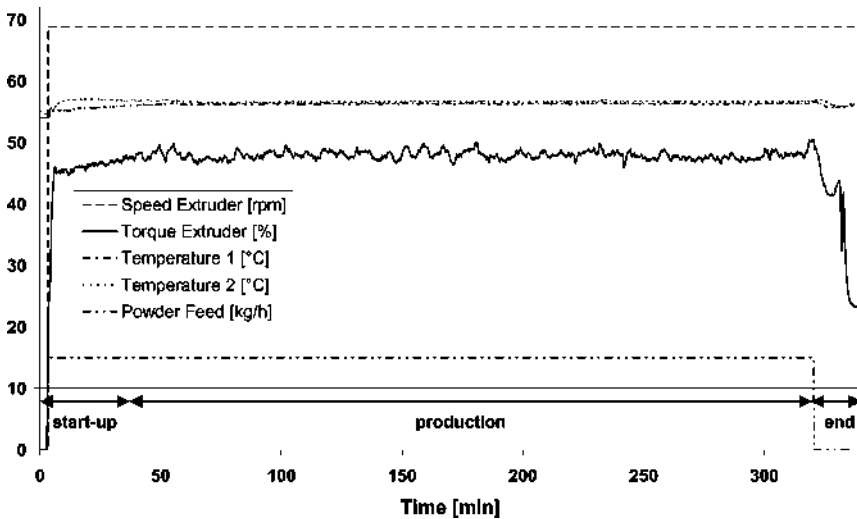
**Figure 17** Sketch of a batch process with requirements for total containment.

## 5.2. Process Control and Automation

As in nearly every continuous production the whole process has to be seen as divided into three phases. The first one or start-up phase begins with the starting of the machine and the raw material supply and ends with the reaching of a stable state of the whole production line. At that point the product reception can be started and the production phase is reached. After the required amount of product is received the feeders are stopped and the process enters the end phase (Fig. 18).

From these facts it is obvious that the yield increases with the batch size. Depending on the intended output and the process requirements a certain amount of raw materials is needed to reach the production phase. In some cases this might be a few grams, in other cases a few kilograms are needed. But it does not depend on the batch size. The product loss during the end phase depends on the machine size because in most cases the yield loss is simply the material remaining inside the machine. Therefore, the most economic way of manufacturing is the use of





**Figure 18** Typical course of an extrusion/granulation process with startup, production, and end phase.

a relatively small machine running in a real continuous manner; this means 24 hr a day and 7 days a week.

Due to the fact that only a small amount of raw materials are processed at the same time it has to be ensured that the instrumentation of the machine allows detecting of any inhomogeneities during production. And furthermore, the measurement has to give reliable values for the product quality.

In terms of the feeding process instrumentation is very easy. As it is standard in the pharmaceutical industry the feeders for the powdery materials are mass-controlled, recognizing any derivations from the set-point. Assuming the use of a combination of a pump and a Coriolis-based flow-meter the same explanations are applicable for the granulation liquid.

Unfortunately, it is more complicated to establish a reliable instrumentation system for the extrusion/granulation section. As a prerequisite one has to assume that the product properties are directly linked to the measured ambient conditions. This means temperature, pressure, and torque. For establishing a stable process it is not necessary to know the correct values, rather it is sufficient to know that the measured values are linked with the interesting ones and do not show major fluctuations. As there will not be any measured value without fluctuations it is necessary to detect the range thereof and the influence on the product behavior at the upper and lower limits, especially in terms of process validation.

Temperature probes are installed inside the middle and end stop ring because these are the locations where the material has to pass a narrow orifice and therefore the highest temperatures can be expected. It is an indirect measurement of the mass temperature by measuring the ring temperature very close to the inner surface. Additionally, the coolant temperatures are detected. Because the ring temperature at the outer surface is set by the coolant the mass temperature is proportional to the detected temperature of the ring.

Pressure probes are also installed at both rings. Due to the size and installation of the rings indirect measurements are useless at these locations. Therefore, the mass pressure is being detected by strain gauges separated from the mass by a diaphragm.

As an average value of the mechanical power intake the torque measurement of the extruder drive is a very important value. Any fluctuation in powder or liquid dosage or speed of the extruder leads to a fluctuation in torque. Additionally, the viscosity of the mass is also influenced by its temperature and pressure. Thus, the torque measurement is also a backbone for the detection of any deviations occurring during granulation. It is taken from the frequency converter of the main drive. Therefore, it does not give absolute values but the possibility of recognizing a process trend that might lead to products being out of specification.

In case of microwave drying it is very important to have a reliable instrumentation. With a view on the needs of the product the interesting values are the holding time of the product inside the dryer, the amount of microwave radiation, the amount of stripping gas and the pressure inside the dryer. Not all products need a very precise holding time due to the special behavior of microwaves. Normally, microwaves affect materials that contain a minimum amount of water or other suitable liquids. When the product is dried microwaves lose the ability to affect the material. Primarily, the drying and heating will occur where it is needed and wanted (9,11).

For security reasons and with respect to the lifetime of the magnetron the microwave reflection is detected. The stripping gas can be controlled by pressure or with a roots pump allowing determining of the gas amount very precisely.

In contrast to the microwave dryer in a contact dryer it is very important to assure constant material flow and thus constant holding times. Therefore, the contact dryer is equipped with a spiral inside the drying pipe to forward the material with a constant speed. Additionally, the temperature of the pipe is determined at all interesting spots.

For both dryers the measurement of the product temperature at the product outlet is a matter of course.

For a comprehensive characterization of the product properties like moisture or active content this application gives the chance of implementing online detection instruments like NIR spectroscopy, for instance. With this powerful instrument it is possible to analyze the complete batch in a nondestructive way. Once calibrated, the measurement can be reduced to a detection of homogeneity that can be carried out very easily.

For automation purposes and deviation control the dependencies of temperature, pressure, and revolution speed for the granulation unit have to be understood very well. The influence of different temperatures can be explained quite easily. Usually, increasing temperatures lead to decreasing viscosities and thus the pressure and the torque will decrease. With an increasing speed of the central spindles the filling ratio inside the extruder will decrease and thereby the pressure and the torque, not taking care of the alternations by increasing temperature caused by a higher friction inside. To make it more difficult at the beginning of a speed increase the pressure increases rapidly and then decreases slowly to a lower level due to the fact that a change of the filling ratio is a slow process.

The pressure is to be seen as a result of speed and temperature and thus not directly controllable. Even the product temperature can be influenced by two or more factors, the temperature of the barrel, the speed of the central spindle, and the physical properties of the materials, mainly the lubricant characteristics and thereby the inner friction.

Summarizing, the regulation circuits of planetary extrusion systems have to be carried out very carefully. When the process reaches the production phase usually regulation circuits are not required if raw material supply and process control can be maintained in a stable status as the measured values are a result thereof. If deviations

occur the regulating steps have to be designed according to the intended process by defining the regulating ranges of each parameter and the dependency algorithms describing the influences on each other.

### 5.3. Typical Granulation Processes

#### 5.3.1. Wet Granulation

As there are countless variations of wet granulation processes it is possible only to demonstrate a small choice of formulations to show the feasibility and limitations of different raw materials. During testing of the granulation unit various excipients of higher importance for solid dosage forms were evaluated to know their behavior under this particular treatment, concentrating more on the behavior with respect to the extrusion system (Table 2). For these particular formulations, it was possible to achieve product temperatures below 50°C after extrusion. Compression after final blending led to tablets of a tensile strength of more than 1.0°MPa in the examined range of 5–15°kN compression force. By using nitrogen injection it was possible to improve the compression characteristics of recipe I due to an increase of the granule porosity (Fig. 19). The disintegration times of the tablets were mostly below 10°min; in some cases, it was adjustable by nitrogen pressure.

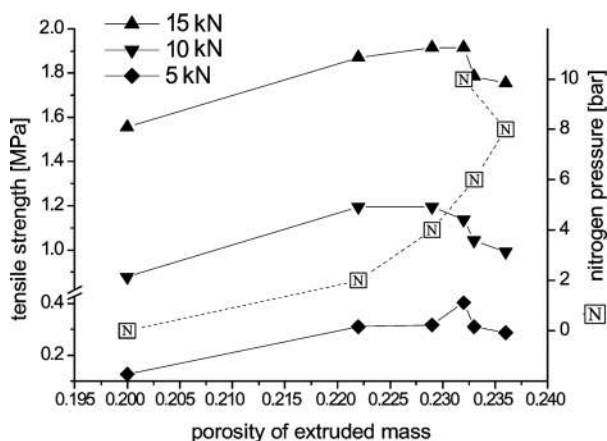
The granules of all placebo blends were of a round and compact structure, leading to excellent flowing properties at an LOD of about 2.5%, which was also the granule moisture before compression.

A different way of evaluating the machine was the granulation of hardly wettable substances in higher concentrations as models for modern actives. As a first granulation, caffeine was granulated with 2.5% of povidone resulting in tablets with

**Table 2** Placebo Formulations

	I	II	III	IV	V	VI
<i>Granules</i>						
Lactose monohydrate	82.5	80.0	70.0	82.0		
Mannitol					72.0	80.0
Corn starch	14.6	15.0	15.0	5.0	10.0	
Cellulose			15.0	10.0	15.0	15.0
Providone	2.9			3.0	3.0	
HPMC						5.0
Povidone, cross-linked		5.0				
<i>Final blend</i>						
Magnesium stearate	0.5	0.5	0.5	0.5	1.0	1.0
Silicon dioxide						
Providone, cross-linked	5.0	2.0	5.0		5.0	5.0
Carboxymethyl-cellulose						
Sodium, cross-linked				3.0		

*Note:* The components of the final blend are to be seen as percentage parts of the dried granules. All values in % (w/w).



**Figure 19** Compression characteristics of recipe I. The second y-axis shows the influence of the nitrogen pressure on the porosity. Porosity was calculated by the quotient of upward pressure of the coated granules in silicon oil as a measure of the apparent density and the true density. The three different charts display the compression characteristics for three compression forces (5–15 kN).

satisfying compression and disintegration behavior and a dissolution  $t_{80}$  value of about 5° min for a tensile strength of 1.0° MPa. Hardening after 2 weeks resulted in useless tablets with a  $t_{80}$  value of nearly 3° hr. This could be avoided by addition of 5% cellulose resulting in stable tablets over a period of 6 months. The components of the final blend were 3% povidone cross-linked, 0.5% silicon dioxide, and 0.5% magnesium stearate.

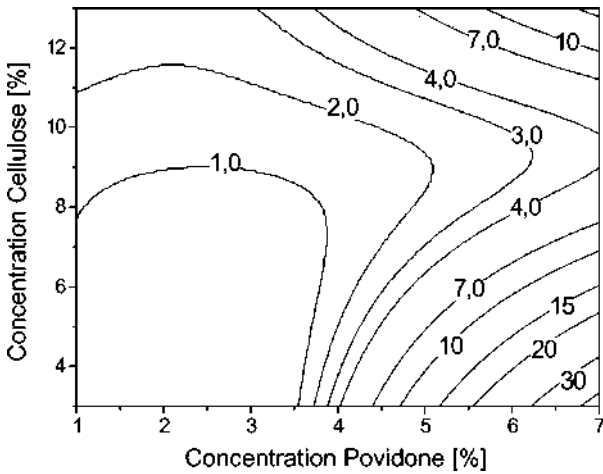
Ibuprofen and mefenamic acid (12), both granulated with 3% povidone and 5% cellulose and afterward blended with the identical substances as for caffeine, could be easily compressed at forces of 4° kN for ibuprofen and 6° kN for mefenamic acid. Disintegration time was 1.7 and 1.0 min for ibuprofen and mefenamic acid, respectively. The dissolution  $t_{80}$  value was 6.7 and 17 min, respectively, stable for the examination period of 6 months. The LOD of the granules before final blending was 1.4%; disintegration and dissolution behaviors were examined at a tensile strength of 1.0° MPa.

A more detailed examination of the ibuprofen granulations as factorial designs (13) showed satisfying granules for povidone concentrations of 1–4% and cellulose concentrations of 3–13% (Figs. 20 and 21). Additionally, HPMC and a special amylose-rich starch type (Eurylon® 7, Roquette) could be classified as suitable for the granulation. The satisfying ranges were 1–4% of HPMC and 3–8% of starch whereas lower concentrations gave better results in disintegration and dissolution (Fig. 22).

Gas injection resulted in worse disintegrating tablets and prolonged dissolution due to the displacement of the hydrophilic binder from the hydrophobic active by the hydrophobic gas resulting in higher contact angles between the granules and water (Table 3).

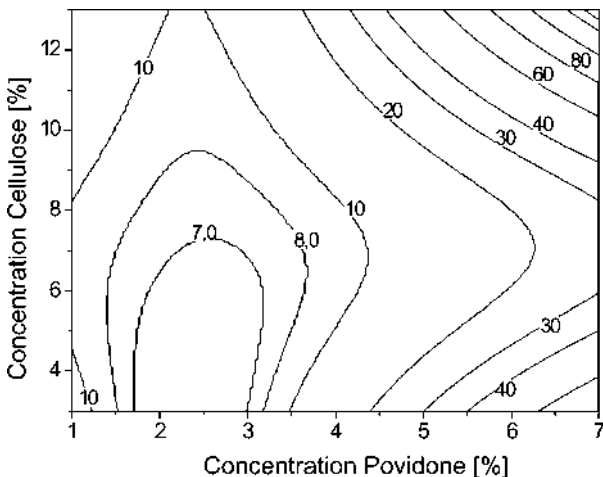
As the results of the aforementioned granulations the following facts could be found:

- Main advantages of this process are the excellent blending quality and temperature control associated with low energy requirements for granulation and drying and a high efficiency of the microwave dryer.

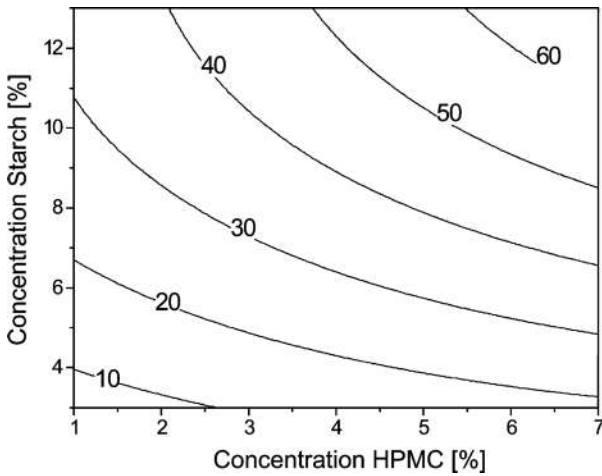


**Figure 20** Dependency of different concentrations of povidone and cellulose on the disintegration times of tablets containing ibuprofen.

- Lactose and mannitol are both suitable as filler ingredients due to their slow solubility in water.
- The necessary amount of water for granulation mainly depends on the lubricating properties of the dry blend. In this process the main purpose of water is lubrication, which enables a very low amount of water of about 7% (w/w) for some blends.
- Ibuprofen could be granulated with active concentrations of maximum 96% (granules) and 92% (tablets); mefenamic acid could be granulated with active concentrations of 92% (granules) and 88% (tablets) as an effect of the excellent blending qualities.
- Cellulose can be used as disintegrant and/or hardening inhibitor in amounts of 3–7% (w/w).



**Figure 21** Dependency of different concentrations of povidone and cellulose on the mean dissolution times of tablets containing ibuprofen.



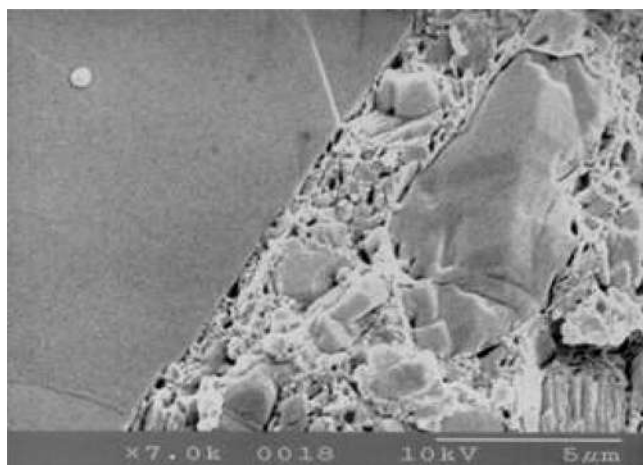
**Figure 22** Dependency of different concentrations of HPMC and starch on the mean dissolution times of tablets containing ibuprofen.

- Corn starch was gelatinized to a high degree even at low temperatures resulting in good dispersion qualities for nitrogen at recipe I. Therefore, starch can be used as a binder added as native powder to the dry blend.
- The process is mainly suitable for the granulation of hardly wettable substances at high concentrations and the granulation of poor or slowly soluble substances.

As an indicator for the excellent blending quality and the high shearing forces brought into the product an SEM picture of a granulate containing mefenamic acid is displayed (Fig. 23). The larger structures of the picture are mefenamic acid crystals. In standard granulation procedures the binder avoids contact with the active resulting in insulated spots of binder on the surface of the active crystals. With this process a forced contact between binder and active is given (small binder bridges in the picture) leading to tablets of higher hardness. Due to the hydrophilization caused by the “binder coating” the disintegration and dissolution are very fast at high active concentrations.

**Table 3** Influence of Nitrogen Pressure on the Disintegration Times, the Mean Dissolution Times of the Tablets, and the Contact Angle between Water and Granules

	Ibuprofen					
	4% HPMC and 8% cellulose			4% HPMC and 8% starch		
Nitrogen pressure (bar)	0.0	1.5	3.0	0.0	1.5	3.0
Disintegration time (min)	33.0	47.9	61.6	17.9	45.2	52.2
Mean dissolution time (min)	20.7	34.4	46.6	25.6	27.4	31.6
Contact angle (°)	73.4	80.6	86.2	75.6	81.1	84.9



**Figure 23** SEM picture of granulate containing mefenamic acid.

### 5.3.2. Melt Granulation

Melt granulation processes are the standard applications for extrusion processes in the pharmaceutical industry. But as this is not a standard machine for manufacturing pharmaceuticals the behavior of the machine during processing and the behavior of the products are hardly comparable to granules manufactured with a single- or twin-screw extruder. The main difference is originated in the working principle. While screw extruders mainly push and shift the material inside the extruder and blending can be carried out with specially constructed blending elements the planetary extruder rolls and blends the material on the whole extrusion length. Therefore, planetary extruders need more lubrication to forward the material but enable excellent blended mixtures. Usually, the material pressures inside are lower than in screw extruders and the mass temperatures are more homogenous. As a result from these considerations formulations transferred from a twin-screw extruder to a planetary extruder have to be slightly adapted.

Exemplarily, [Figure 18](#) shows the process parameters of a pharmaceutical melt extrusion process developed on a corotating twin-screw extruder.

## 5.4. Differences Compared to Classical Granulation Processes

The main advantages compared to classical granulation methods as high-shear granulation or fluid bed granulation arise from the continuous way of manufacturing in contrast to the batch-wise orientation of the classical ones. Usually, the output of a continuously working machine is expressed in mass per time allowing adjusting of the batch size by changing the process time or, to be more precise, the production time of the process ([Fig. 18](#)). Therefore, in a certain range the batch size is independent of the machine size, which makes scale-up for processes developed on a continuous machine much easier. Even during production the batch size can be chosen freely depending on the need for that particular product.

The product quality can be ensured due to the fact that at the same time only a small amount of raw material stays inside the machine for being processed. Furthermore, it is obvious that the actual energy intake is lower than in a batch oriented

granulation process for the equivalent batch size. Resulting from the constant product flow, inhomogeneities in the means of blending or binder distribution can be detected and avoided by the instrumentation of the granulation unit and detected at the end of the process by a nondestructive inline measurement tool like NIR spectroscopy for instance. Therefore, it is not necessary to rely on a small amount of samples for release; moreover, the whole batch can be analyzed.

For a stable process after reaching the production cycle there is no alternation in any of the process parameters in a certain range as all parts of the machine are running at the same time. A separation in several production steps like in known granulation machines is not given. This makes it very easy to detect deviations during production.

## ACKNOWLEDGMENTS

The authors thank Dr. Daniel Rytz and Dr. Bernhard Luy of Glatt, Klaus Schörnborner of Heinen, Reiner Lemperle of Lödige and Harald Stahl of Niro/Aeromatic-Fielder Division for their support in the preparation of this chapter.

## REFERENCES

1. Dittgen M, Kala H, Moldenauer H, Zessin G, Schneider J. Zur pharmazeutischen Technologie der Granulierung. *Pharmazie* 1980; 35(4):237–S249.
2. Kristensen H. Particle Agglomeration. *Advances in Pharmaceutical Sciences*. London: Academic Press, 1990:221–272.
3. Paul S. Pharmazeutische Eignung von Verfahren zur kontinuierlichen Granulation. Dissertation, Erlangen-Nürnberg, 1996.
4. Product Information, Aeromatic-Fielder.
5. Product Information, Glatt GmbH.
6. Product Information, Gebr. Lödige GmbH.
7. Püschner H. Wärme durch Mikrowellen. Eindhoven, The Netherlands: Philips Tech. Bibl., 1964.
8. Lüchtfeld S. Mischer lässt Planeten kreisen. *Chemie Technik* 1998; 27(6):66–68.
9. Parikh D, ed. *Handbook of Pharmaceutical Granulation Technology*. 1st. ed. Vol. 81. New York: Marcel Dekker, 1997.
10. Schütte A. Untersuchungen zur Feuchtgranulierung hydrophober Arzneistoffe am Beispiel der Mefenaminsäure. Dissertation, Bonn, 2001.
11. Stahl H. Trocknung pharmazeutischer Granulate in Eintopfssystemen. *Pharm Ind* 1999; 61(7):656–661.
12. Schmidt PC, Christin I. *Wirk- und Hilfsstoffe für Rezeptur, Defektur und Großherstellung*. 1st ed. Stuttgart: Wiss. Verl. Ges., 1999.
13. Davies O. *The Design and Analysis of Industrial Experiments*. 2nd ed. London: ICI, 1978:Longman.
14. Rauwendaal C. *Understanding Extrusion*. Munich: Carl Hanser Verlag, 1998.
15. Stahl PH. Feuchtigkeit und Trocknen in der pharmazeutischen Technologie. Darmstadt: Steinkopff, 1980.
16. Dietrich R, Brause R. Erste Erfahrungen und Validierungsversuche an einem neu entwickelten GMP—gerechten und instrumentierten Pharma-Extruder. *Pharm Ind* 50 1988; 50:1179–1186.
17. Fikentscher H, Herrle K. Polyvinylpyrrolidone. *Mod Plast* 1945; 23(3):157–161,212,214,216,218.



18. Goodhart FW, Draper JR, Nizer FC. Design and use of a laboratory extruder for pharmaceutical granulations. *J Pharm Sci* 1973; 62:133–136.
19. Keleb EI, Vermeire A, Vervaet C, Remon JP. Cold extrusion as a continuous single-step granulation and tableting process. *Eur J Pharm Biopharm* 2001; 52S:359–368.
20. Kibbe AH, ed. In: *Handbook of Pharmaceutical Excipients*. 3rd ed. London: Pharmaceutical Press, 2000.
21. Kleinebudde P, Lindner H. Experiments with an instrumented twin-screw extruder using a single-step granulation/extrusion process. *Int J Pharm* 1993; 94S:49–58.
22. Lindner H, Kleinebudde P. Use of powdered cellulose for the production of pellets by extrusion spheronization. *J Pharm Pharmacol* 1994; 46:2–7.
23. Scheffler E. *Statistische Versuchsplanung und auswertung, Eine Einführung für Praktiker*. 3rd ed. Stuttgart: Dt. Verl. Für Grundstoffindustrie, 1997.
24. Sucker H. *Methoden zum Planen und Auswerten von Versuchen: I. Factorial Design, eine Einführung*, Informationsdienst der APV. 1971; 17:52–68.

# 16

## Scale-Up Considerations in Granulation

**Y. He, L. X. Liu, and J. D. Litster**

*Particle and Systems Design Centre, Division of Chemical Engineering,  
School of Engineering, The University of Queensland,  
Queensland, Australia*

### 1. INTRODUCTION

Scale-up of any engineering process is a great technical and economic challenge. Scale-up of granulation processes, in particular, is difficult and often problematic due to the inherently heterogenous nature of the materials used. However, recent improved understanding of the rate processes that control granulation improves our ability to do rational scale-up.

There are two situations where process scale-up is needed: (1) commercialization of newly developed processes and products and (2) expansion of production capacities in response to increased market demand.

For pharmaceutical applications, the challenge is almost always associated with new product development. Scale-up in the pharmaceutical industry is unique in that experiments at laboratory and pilot scale are also required to produce product of the desired specification for different stages of clinical trials. This gives additional constraints and challenges to engineers and technologists during scale-up.

A change in scale invariably impacts on process conditions and, consequently, on the product quality. For pharmaceutical industries, the Food and Drug Administration (FDA) ranks the impacts on the drug product arising from changes of process conditions including production scales into three levels as shown in [Table 1](#) (1). Level 1 is reserved for changes that are unlikely to have any detectable impact on the formulation quality and performance (2). For all practical purposes, scale-up should aim to achieve an impact equivalent to or less than Level 1.

In this chapter, we will first consider general scale-up approaches from a chemical engineering perspective. We will then look specifically at understanding pharmaceutical granulation scale-up through considering granulation as a combination of rate processes. Each rate process is affected by changes in process during scaling, as well as by formulation decisions. Finally, we will present suggestions for scaling of fluid-bed and high-shear mixer granulation that follow from this approach.

**Table 1** Scale-Up and Postapproval Changes Level Component or Composition Change Levels

Excipient	% Excipient (w/w of total dosage unit)		
	Level 1	Level 2	Level 3
Filler	±5	±10	> 10
Disintegrant			
Starch	±3	±6	> 6
Other	±0.5	±1	> 1
Binder	±0.5	±1	> 1
Lubricant			
Ca or Mg Stearate	±0.25	±0.5	> 0.5
Other	±1	±2	> 2
Glidant			
Talc	±1	±2	> 2
Other	±0.1	±0.2	> 0.2
Film coat	±1	±2	> 2
Total drug recipient change (%)	5	10	N/a

Source: Adapted from Ref. 2.

## 2. GENERAL CONSIDERATIONS IN PROCESS SCALE-UP: DIMENSIONAL ANALYSIS AND THE PRINCIPLE OF SIMILARITY

It is important to recognize that designing a commercial scale operation via several stages of scale-up is, in one sense, an admission of failure. If we have a strong understanding of our processes, then full-scale design can be performed using appropriate mathematical models, given feed formulation properties and clear required product specifications. Mature chemical engineering processes, such as distillation, are designed this way.

However, most solids processing technology do not have this level of maturity yet. In this case, scale-up studies reduce uncertainties in the design and operation of the scaled unit most economically. On this basis, the starting point in scale-up must really be the commercial unit. In theory, once sufficient information for the commercial unit is known, scale-up can be done by applying the similarity principles from data collected on a smaller unit. The similarity principle states (3): Two processes can be considered similar if they take place in similar geometric space and all dimensionless groups required to describe the processes have the same numerical values.

To establish the necessary dimensionless groups, a systematic dimensional analysis needs to be carried out where Buckingham  $\Pi$  theorem is used to reduce the number of dimensionless groups (4). Assuming that a process can be described by  $k$  variables, we can express one variable as a function of the other  $k - 1$  variables, i.e.,

$$x_1 = f(x_2, x_3, \mathbf{K}, x_{k-1}) \quad (2.1)$$

To conform to the dimensional homogeneity, the dimensions of the variable on the left-hand side of the equation must be equal to those on the right-hand side. With some simple mathematical rearrangements, Eq. 2.1 can be transformed into an

equation of dimensionless groups ( $\Pi$  terms), i.e.,

$$\Pi_1 = \phi(\Pi_2, \Pi_3, K, \Pi_{k-r}) \quad (2.2)$$

Eq. 2.2 is a relationship among  $k-r$  independent dimensionless products, where  $r$  is the minimum number of reference dimensions required to describe the variables. While the Buckingham  $\Pi$  theorem itself is straightforward, development of a dimensionless expression for a process or a phenomenon requires a systematic dimensional analysis [Ref. 4 for more details]. For most engineering problems, variables can be divided into three groups: (1) geometric variables, (2) material property variables, and (3) process variables. The reference dimensions are normally the basic dimensions such as mass ( $M$ ), length ( $L$ ), and time ( $T$ ).

It is important to note that a systematic dimensional analysis can only be applied to processes where a clear understanding of the processes is established. Omission of any important variables of the process will lead to an erroneous outcome of the dimensional analysis, inevitably causing major problems in scale-up. Zlokarnik et al. (3) divided the application of dimensional analysis to five general cases with different levels of understanding in each case:

1. The science of the basic phenomenon is unknown—dimensional analysis cannot be applied;
2. Enough is known about the science of the basic phenomenon to compile a tentative draft list—the resulting  $\Pi$  set is unreliable;
3. All the relevant variables for the description of the problems are known—application of dimensional analysis is straight forward;
4. The problem can be described by a mathematical equation—mathematical functions are better than  $\Pi$  relationships, which may help reducing the number of dimensionless groups.
5. A mathematical solution of the problem exists—application of dimensional analysis is unnecessary.

Clearly, the more we understand a process or phenomenon, the better we can scale it up with confidence.

Full application of the similarity principle requires all the relevant  $\Pi$  groups to be measured at the small scale and kept constant during scale-up. Unfortunately, most industrial processes are very complex with many physical and chemical phenomena occurring. This leads to a large set of dimensionless groups required to fully characterize the process. This is particularly the case with processes involving particulate materials such as granulation. Maintaining all the dimensionless groups constant on the two scales is very difficult, if not impossible, due to constraints on the degrees of freedom in variables that can be changed on scale-up. In this case, scale-up can only be done on the basis of “partial similarity.” That is, not all dimensionless numbers can be maintained the same on the two scales.

To scale up on the basis of partial similarity, experiments are carried out on a succession of equipment at different scales and results extrapolated to the final scale. That is, the scale-up ratio is kept low. With conflicting requirements on the dimensionless groups during scale-up, a common approach is to maintain one dimensionless group constant and check the effect of other dimensionless groups on the dependent variable by varying these dimensionless groups during experimentation. Once determined, only the dominant dimensionless number will be kept constant on scale-up. This partial similarity approach is often applied to granulation.

### 3. ANALYSIS OF GRANULATION RATE PROCESSES AND IMPLICATIONS FOR SCALE-UP

Many of the required granule product attributes are directly related to the size, size distribution, and density of the granule product. These granule properties develop as a result of three classes of rate process in the granulator (Fig. 1):

1. Wetting and nucleation
2. Growth and consolidation
3. Breakage and attrition.

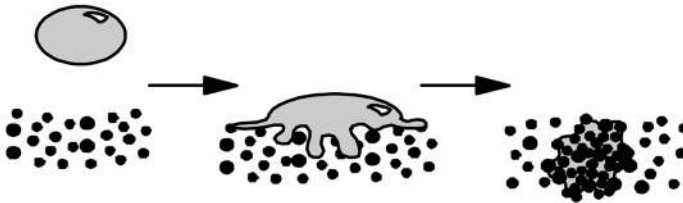
Each of these processes is analyzed in depth in Litster and Ennis (5). In this section, we will summarize each rate process in turn, particularly highlighting the main formulation properties and process variables. Wherever possible, we will define dimensionless groups that can be used in scale-up.

#### 3.1. Wetting and Nucleation

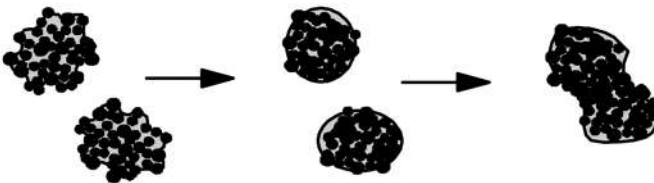
The first step in granulation is the addition of a liquid binder to the powder to form nuclei granules. Within the granulator, the key region for wetting and nucleation is the spray zone where liquid binder droplets contact the moving powder surface. The nucleation process is considered to consist of four stages (Fig. 2):

1. Droplet formation
2. Droplet overlap and coalescence at the bed surface

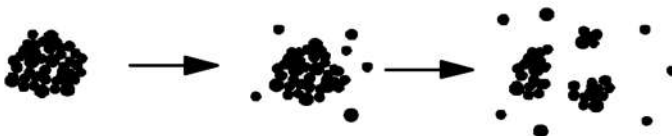
##### (i) Wetting & Nucleation



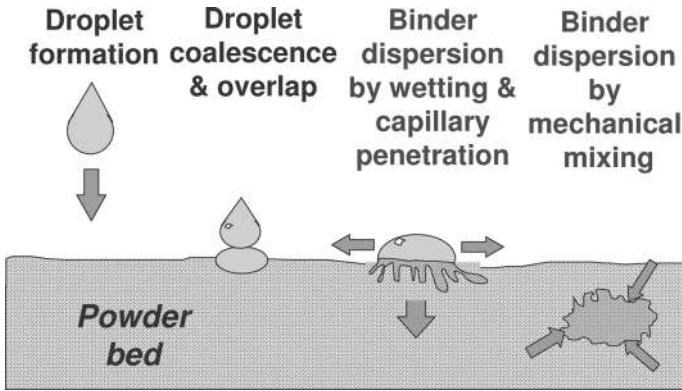
##### (ii) Consolidation & Coalescence



##### (iii) Attrition & Breakage



**Figure 1** A classification of granulation rate processes. (From Ref. 5.)



**Figure 2** Wetting and nuclei formation in the spray zone of a granulator.

3. Drop penetration into the bed by capillary action
4. Mechanical dispersion of large clumps within the powder bed (only applicable to mixer granulators).

Poor wetting and nucleation lead to broad granule size distributions and poor distribution of the liquid binder, which increases substantially the chances of poor drug distribution. Despite the action of other rate processes, the broad size distributions and poor liquid distribution often persist throughout the granulation.

For ideal nucleation, the granulator should operate in the drop-controlled regime. Here, each drop which hits the powder bed penetrates into the bed to form a single nucleus granule. There is (almost) no drop overlap at the bed surface and mechanical dispersion of large, wet powder clumps is unnecessary.

To predict the required conditions for drop-controlled nucleation we must understand

1. The thermodynamics and kinetics of drop penetration, largely controlled by formulation properties
2. The flux of drops onto the bed surface, largely controlled by process parameters.

The drop penetration time  $t_p$  can be estimated using a model, which considers the rate at which liquid flows into the pores in the powder surface under capillary action (6):

$$t_p = 1.35 \frac{V_0^{2/3}}{\varepsilon_{\text{eff}}^2 R_{\text{eff}} \gamma_{\text{LV}} \cos\theta} \mu \quad (3.1)$$

where  $V_0$  is the drop volume,  $\mu$  is the liquid viscosity, and  $\gamma_{\text{LV}} \cos\theta$  is the adhesive tension between the liquid and the powder. The effective pore size  $R_{\text{eff}}$  and porosity  $\varepsilon_{\text{eff}}$  of the powder bed are given by

$$R_{\text{eff}} = \frac{\phi d_{32}}{3} \frac{\varepsilon_{\text{eff}}}{(1 - \varepsilon_{\text{eff}})} \quad (3.2)$$

$$\varepsilon_{\text{eff}} = \varepsilon_{\text{tap}}(1 - \varepsilon + \varepsilon_{\text{tap}}) \quad (3.3)$$

where  $\varphi$  is the particle sphericity,  $d_{32}$  is the specific surface mean particle size,  $\varepsilon$  is the loose packed bed porosity, and  $\varepsilon_{\text{tap}}$  is the tapped bed porosity.

For drop-controlled nucleation, the drop penetration time must be small compared to the bed circulation time  $t_c$  before that section of powder passes again through the spray zone, i.e., the dimensionless penetration time should be small:

$$\tau_p = \frac{t_p}{t_c} < 0.1 \tag{3.4}$$

To avoid drop overlap on the bed surface and caking of the powder, the dimensionless spray flux  $\psi$  must also be kept small.  $\psi_a$  is the ratio of the rate of production of drop projected area by the nozzle to the rate at which powder surface area passed through the spray zone and is defined as

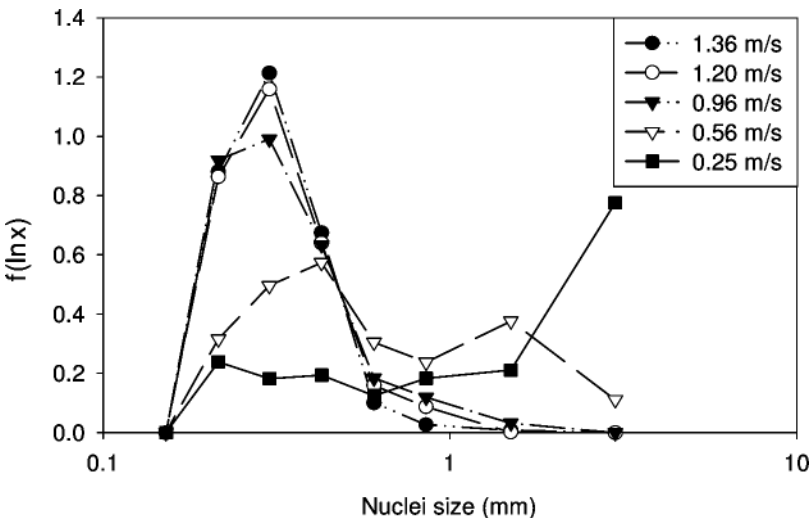
$$\psi_a = \frac{3V}{2Ad_d} \tag{3.5}$$

Figure 3 shows how the nuclei granule size distribution broadens as the spray flux increases. For drop-controlled nucleation, the dimensionless spray flux should be kept  $< 0.2$ . For  $\psi_a > 0.7$  the surface of the powder bed in the spray zone is effectively caked.

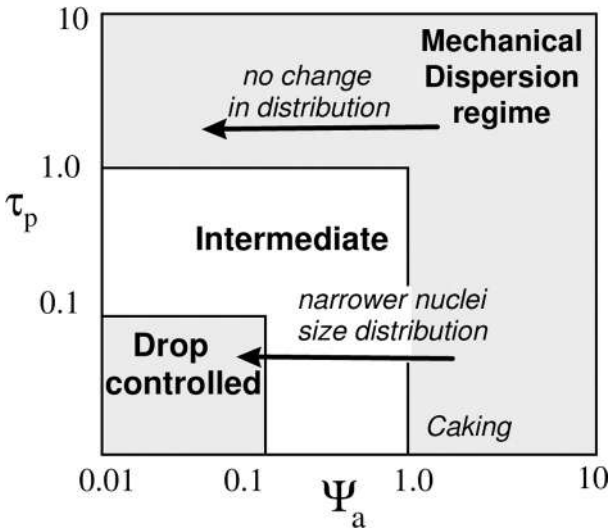
We can represent the nucleation behavior in a regime map (Fig. 4). Drop-controlled nucleation is achieved only when both  $\psi_a$  and  $\tau_p$  are low. Figure 5 shows an example of full granulation data from a 25 L fielder mixer granulator on this type of regime map. The granule size distribution is much narrower when nucleation is kept in the drop-controlled regime (lower left-hand corner). This illustrates that poor nucleation usually results in broad final granule size distributions despite the impact of other processes occurring in the granulator.

### 3.2. Growth and Consolidation

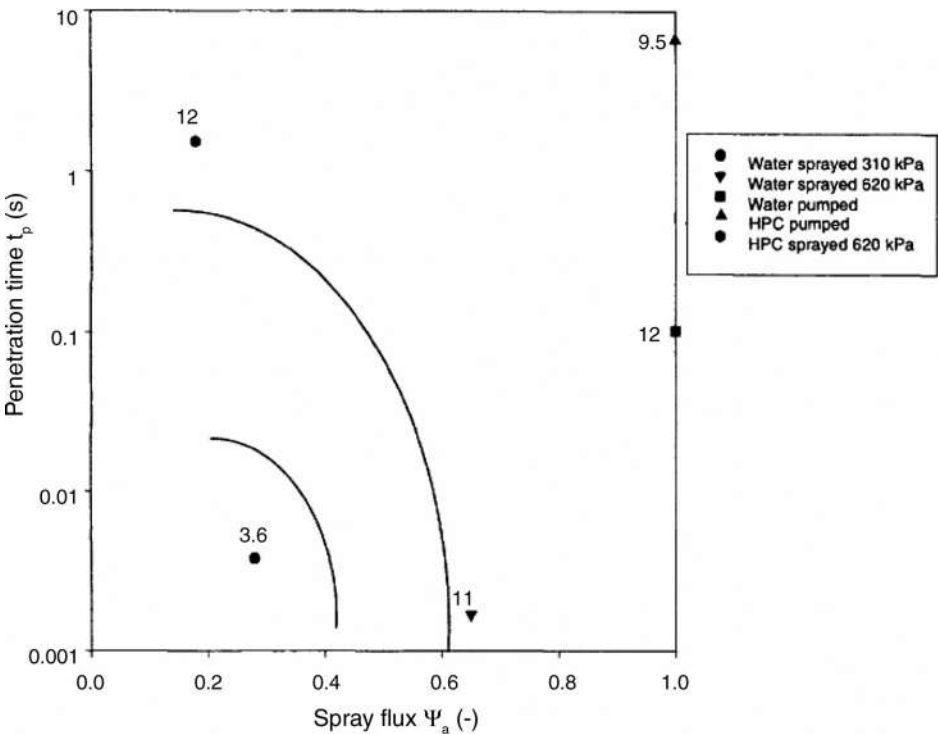
Granule growth is very complex. The key question in establishing growth behavior is: Will two granules which collide in a granulator stick together (coalesce) or



**Figure 3** Effect of powder velocity on nuclei size distribution for lactose with water at 310 kPa. (From Ref. 6.)



**Figure 4** Nucleation regime map. For ideal nucleation in the drop-controlled regime, it must have (1) low  $\psi_a$  and (2) low  $t_p$ . In the mechanical dispersion regime, one or both of these conditions are not met, and good binder dispersion requires good mechanical mixing.



**Figure 5** Nucleation regime map in 25 L Fielder mixer at 15% liquid content. Merck lactose with water and HPC as liquid binders. (From Ref. 6.)



rebound? To answer this question it is useful to look at two extreme cases, which cover most applications:

*Deformable porous granules:* These granules are typically formed by a nucleation process described earlier with the drop size of the same order, or larger, than the powder size. Most of the liquid in the granule is contained in the pores between particles in the granule and held there by capillary action. For successful coalescence, this liquid must be made available at the contact point between colliding granules. This model is often suitable for drum mixer granulation.

*Near-elastic granules:* Here, the wetted granule is considered as a nearly elastic sphere with a liquid layer on the surface. This is a good model for cases where the drop size is much smaller than the granule size and the granulator has simultaneous drying. This model is often suitable for fluid-bed granulation.

The different growth modes for deformable porous granules can be represented on a regime map (Fig. 6). For growth to occur by coalescence, the liquid content needs to be large enough to provide 85–105% saturation of the pores in the granule. Granules that are weak, i.e., form large contact areas on collision, fall into the steady growth regime. When two granules collide, a large contact area is formed and liquid is squeezed into the contact area, allowing successful coalescence. In this regime, granules grow steadily and the growth rate is very sensitive to moisture content (Fig. 7A).

Strong granules do not deform much on collision and granules rebound, rather than coalesce. However, as granules consolidate slowly, eventually liquid is squeezed into the granule surface and this liquid layer causes successful coalescence. This is the

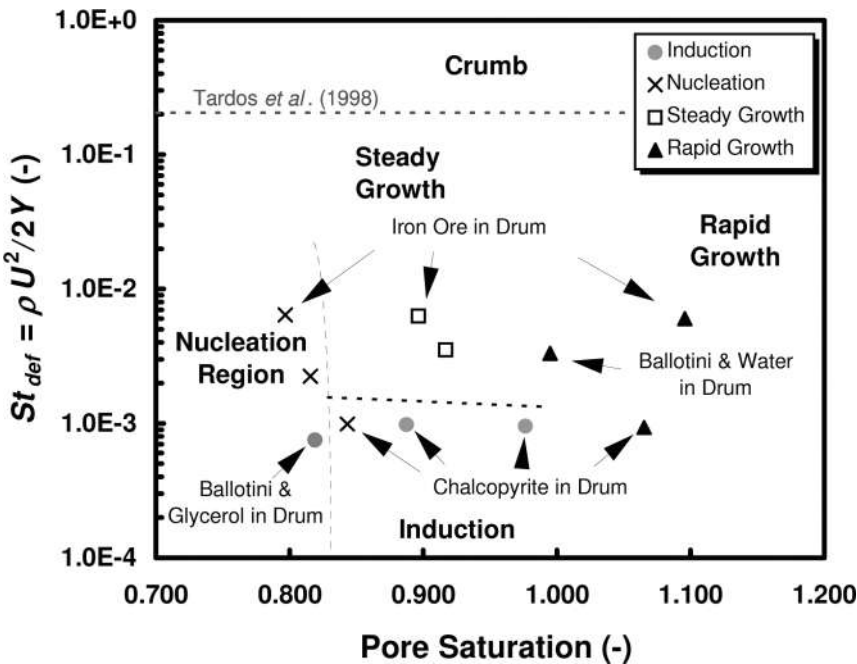
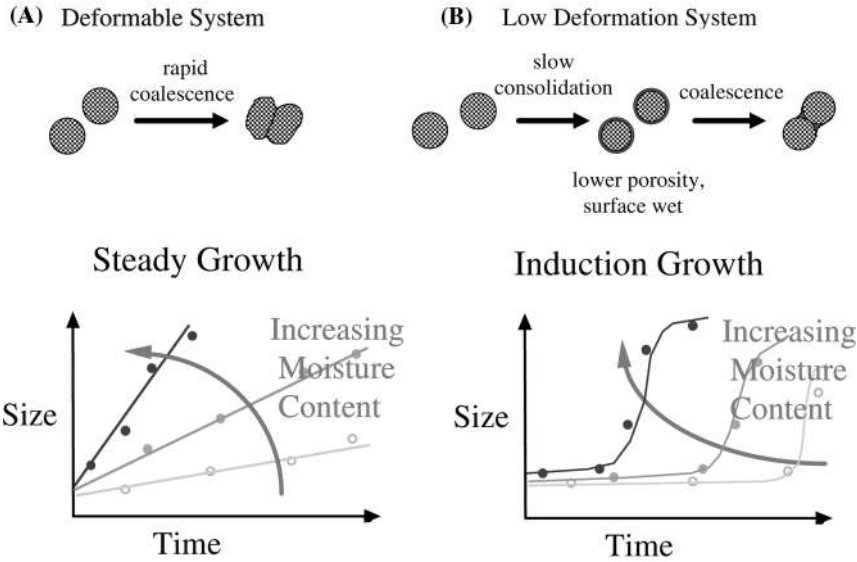


Figure 6 Granule growth regime map. (From Ref. 7.)



**Figure 7** Coalescence growth modes for deformable granules.

induction growth regime (Fig. 7B). At lower moisture contents, nuclei granules form and consolidate. Some growth by layering may occur, but there is insufficient liquid for growth by coalescence. This is the nucleation regime. Very weak granules simply fall apart and cannot sustain growth. This is the crumb regime.

There are two dimensionless groups that dictate the growth behavior, the Stokes deformation number  $St_{\text{def}}$  and the maximum pore saturation  $s_{\text{max}}$ , which are defined as

$$St_{\text{def}} = \frac{\rho_g U_c^2}{2Y} \quad (3.6)$$

$$s_{\text{max}} = \frac{w\rho_s(1 - \varepsilon_{\text{min}})}{\rho_l \varepsilon_{\text{min}}} \quad (3.7)$$

where  $\rho_g$ ,  $\rho_s$ , and  $\rho_l$ , are the granule, particle, and liquid densities, respectively;  $U_c$  is the effective granule collision velocity;  $Y$  is the granule yield strength;  $w$  is the liquid content (kg liquid/kg dry powder); and  $\varepsilon_{\text{min}}$  is the minimum granule porosity after complete consolidation.

Understanding where your system sits on the growth regime map is important for troubleshooting and scale-up. Granules that grow in the induction regime are easy to scale with respect to granule size, provided that the induction time is not exceeded. However, granule density often changes with scale because consolidation kinetics are important and these kinetics can change with scale. On the other hand, in the steady growth region it is difficult to control granule size, but granule density quickly settles to a minimum value and varies little with process parameters.

To make effective use of the granulation regime map we need reasonable estimates of the effective collision velocity  $U_c$  (controlled by process conditions) and dynamic yield stress  $Y$  (a function of formulation properties). Table 2 gives estimates of the average and maximum collision velocities for different process equipment. In

**Table 2** Estimates of  $U_c$  for Different Granulation Processes

Type of granulator	Average $U_c$	Maximum $U_c$
Fluidized beds	$(6U_b d_p)/d_b$	$(6U_b d_p)/d_b \delta^2$
Tumbling granulators	$\omega d_p$	$\omega D_{\text{drum}}$
Mixer granulators	$\omega_i d_p, \omega_c d_p$	$\omega_i D, \omega_c D_c$

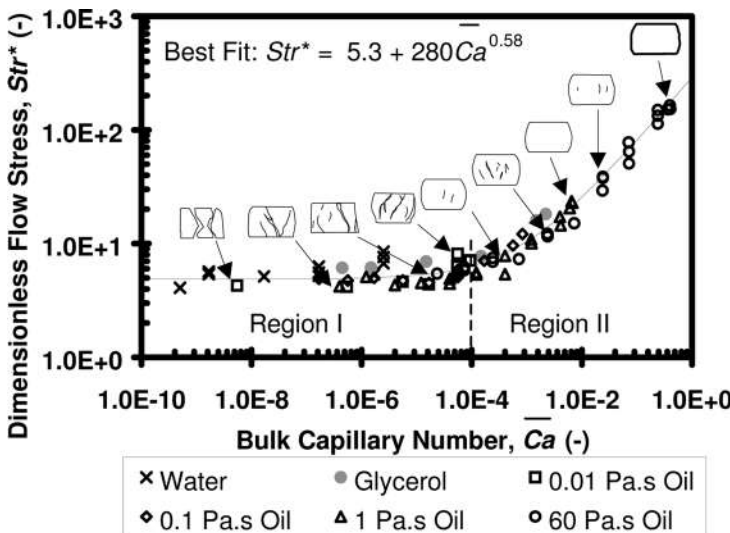
Source: From Ref. 5.

high-shear mixers, the difference between the average and maximum collision velocities can be very large.

The dynamic yield stress of the granule matrix is a function of strain rate due to the contribution of viscous dissipation to the granule strength. Therefore, it is dangerous to use static strength measurements to predict performance in the granulator. Iveson et al. (8) show how dynamic yield stress can be estimated from peak flow stress measurements in a high-speed load frame. They were able to correlate data for different formulations and strain rates in a single line when plotted as the dimensionless peak flow stress ( $Str^*$ ) vs. the capillary number ( $Ca$ ) (Fig. 8). This line can be fitted by a simple empirical equation of the form

$$Str^* = k_1 + k_2 Ca^n \tag{3.8}$$

where  $Str^* = \sigma_{pk} d_p / \gamma \cos \theta$  is the dimensionless peak flow stress,  $Ca = \mu \dot{\epsilon} d_p / \gamma \cos \theta$  is the ratio of viscous to capillary forces,  $\sigma_{pk}$  is peak flow stress,  $\dot{\epsilon}$  is the bulk strain rate, and  $\theta$  is the solid-liquid contact angle.  $k_1$  gives the static strength of the pellets.  $k_2$  determines the transition between strain-rate independent and strain-rate dependent behavior.  $n$  is an exponent which gives the power law dependency of the flow stress on viscosity and strain rate. The best-fit value of  $n$  was found to be  $0.58 \pm 0.04$  and the transition between strain-rate independent and dependent flow stress occurred at  $Ca \sim 10^{-4}$ .



**Figure 8** Dimensionless flow stress vs. capillary number for widely sized 35  $\mu\text{m}$  glass ballotini with six different binders.

The rate of consolidation of granules can also be correlated with  $St_{\text{def}}$  in the form

$$k_c = \beta_c \exp(a \times St_{\text{def}}) \quad (3.9)$$

where  $\beta_c$  and  $a$  are constant,  $k_c$  is the consolidation rate constant for a first-order consolidation equation of the form

$$\frac{\varepsilon - \varepsilon_{\text{min}}}{\varepsilon_0 - \varepsilon_{\text{min}}} = \exp(-k_c t) \quad (3.10)$$

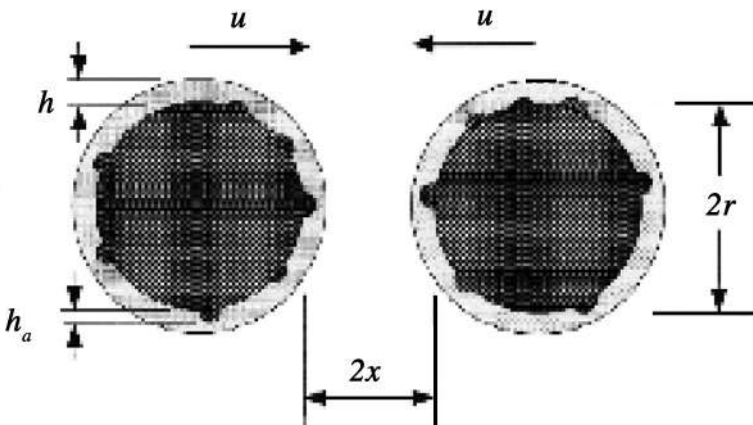
For near-elastic granules the conceptual model originally developed by Ennis et al. (9) considers the collision between two near-elastic granules each coated with a layer of liquid (Fig. 9). In this case the key dimensionless group is the viscous Stokes number  $St_v$

$$St_v = \frac{4\rho_g U_c d_p}{9\mu} \quad (3.11)$$

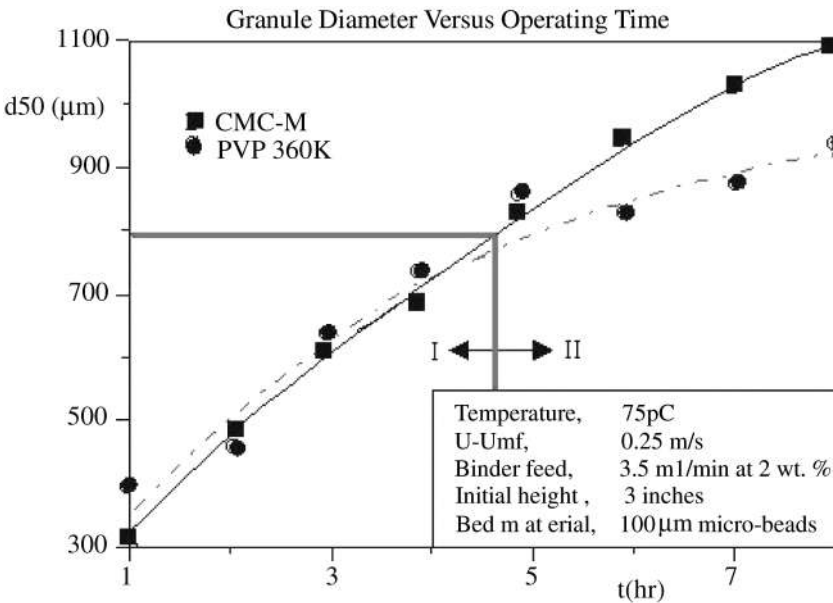
$St_v$  is the ratio of the kinetic energy of the collision to the viscous dissipation in the liquid layer. Successful coalescence will occur if  $St_v$  exceeds some critical value  $St^*$  and we can define three growth regimes as follows:

*Noninertial growth* ( $St_{v,\text{max}} < St^*$ ): The viscous Stokes number for all collisions in the granulator is less than the critical Stokes number. All collisions lead to sticking and growth by coalescence. In this regime, changes to process parameters will have little or no effect on the probability of coalescence.

*Inertial growth* ( $St_{v,\text{av}} \approx St^*$ ): Some collisions cause coalescence while the others lead to rebound. There will be steady granule growth by coalescence. The extent and the rate of growth will be sensitive to process parameters which will determine the proportion of collisions that lead to coalescence. Varying process parameters and formulation properties can push the system into either the noninertial or the coating regimes.



**Figure 9** Two near-elastic granules colliding—the basis for the coalescence/rebound criteria. (From Ref. 9.)



**Figure 10** Growth of glass ballotini granules in a fluidized bed with binders of different viscosity. (From Ref. 9.)

*Coating regime* ( $St_{v,\min} > St^*$ ): The kinetic energy in most or all collisions exceeds viscous dissipation in the liquid layer. There is no coalescence. Granule growth will only occur by the successive layering of new material in the liquid phase (melt, solution, or slurry) onto the granule.

Figure 10 shows an example of granule growth in a fluidized bed where the growth regime changes as the granules grow. Glass ballotini is grown with two liquid binders of different viscosity. Initially, both systems grow steadily at the same rate (noninertial regime). When the granule size reaches  $\approx 800 \mu\text{m}$ , the PVP bound granule growth begins to slow down indicating a transition to the inertial growth regime (only some collisions are successful). Finally, the PVP granules level off at a maximum size of  $\approx 900 \mu\text{m}$  showing transition to the coating regime, where no granule collisions are successful. In contrast, the more viscous CMC-M granules grow steadily throughout the 8 hr experiment, i.e., they remain in the noninertial regime for the whole experiment.

### 3.3. Breakage and Attrition

Breakage and attrition really cover two separate phenomena:

1. Breakage of wet granules in the granulator
2. Attrition or fracture of dried granules in the granulator, drier, or in subsequent handling.

Breakage of wet granules will influence and may control the final granule size distribution. It is only an important phenomenon for high-shear granulators. Wet granule breakage is much less studied than nucleation and growth. There is very little

quantitative theory or modeling available to predict conditions for breakage, or the effect of formulation properties on wet granule breakage.

Tardos et al. (10) considered that a granule breaks if the applied kinetic energy during an impact exceeds the energy required for breakage. This analysis leads to a Stokes deformation number criteria for breakage:

$$St_{\text{def}} > St_{\text{def}}^* \quad (3.12)$$

where  $St_{\text{def}}^*$  is the critical value of Stokes number that must be exceeded for breakage to occur. However, this model is probably an oversimplification. Figure 8 shows schematics of the failure mode of different formulations in dynamic yield strength measurements. Failure behavior varies widely from semibrittle behavior at low capillary numbers to plastic failure at high capillary numbers. We expect a purely plastic granule to smear rather than break when its yield stress is exceeded. At high impeller speeds such materials will coat the granulator wall or form a paste. Semibrittle granules will break at high-impact velocity giving a maximum stable granule size or a weak crumb. Nevertheless, Eq. 3.12 provides a good starting point for quantifying wet granule breakage.

Dry granule attrition is important where drying and granulation occur simultaneously (e.g., in fluidized beds) and in subsequent processing and handling of the granular product. We can consider dry granule breakage as brittle or semibrittle phenomena. The key granule properties that control the breakage are the granule fracture toughness  $K_c$  and the flaw or crack size  $c$  in the granule.  $K_c$  is set by formulation properties, while  $c$  is closely related to granule porosity controlled by the consolidation process in the granulator.

Dry granule breakage usually results in production of fines by wear, erosion, or attrition brought about by diffuse microcracking. Within a fluid bed there are a large number of low-velocity collisions between particles as they shear past each other. This process is analogous to abrasive wear. For abrasive wear of agglomerates, the volumetric wear rate  $V$  is given by (11)

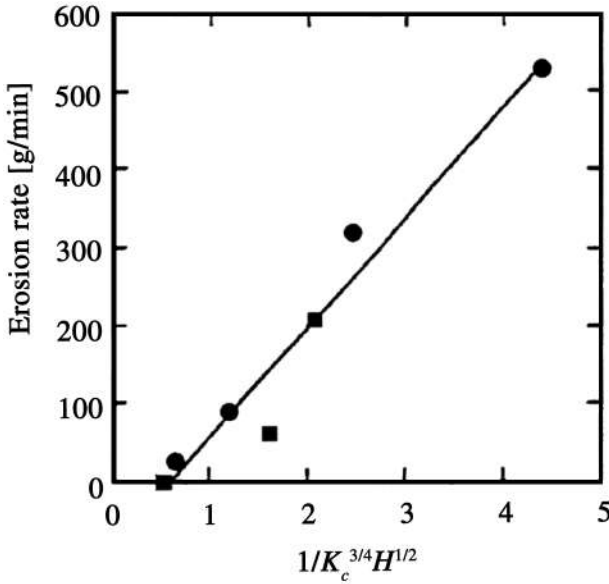
$$V = \frac{d_i^{1/2}}{A^{1/4} K_c^{3/4} H^{1/2}} P^{5/4} l \quad (3.13)$$

where  $d_i$  is indenter diameter,  $P$  is applied load,  $H$  is the hardness of the particles,  $l$  is wear displacement of the indenter, and  $A$  is the apparent area of contact of the indenter with the surface. The number and relative velocity of the collisions depend on the number of bubbles in the bed and hence the excess gas velocity ( $u - u_{\text{mf}}$ ). The applied pressure in a fluid bed depends on bed depth. Thus, the attrition rate  $B_w$  in a fluidized bed granulator is

$$B_w = \frac{d_0^{1/2}}{K_c^{3/4} H^{1/2}} L^{5/4} (u - u_{\text{mf}}) \quad (3.14)$$

where  $d_0$  is the distributor hole orifice size and  $L$  is the fluidized bed height. Figure 11 shows the attrition rates of several formulations in a fluidized bed with a direct correlation between attrition rate and the material properties grouping in Eq. 3.13 and (3.14).

Note that Eq. 3.13 and (3.14) only hold for breakage via a wear mechanism. For attrition during impact or compaction, there are different dependencies of the attrition rate on the materials properties [Ref. 5 for more details].



**Figure 11** Erosion rates of agglomerate materials during attrition of granules in a fluidized bed. (From Ref. 12.)

### 3.4. Implications for Scale-Up

Table 3 summarizes the key controlling dimensionless groups for the rate processes described earlier and the main process parameters and formulation properties that impact on these groups.

In addition to these groups, there are dimensionless groups to describe: (1) the geometry of the equipment and (2) the flow of the powder and granules in the granulator. Both these classes of controlling groups are very equipment dependent.

For scale-up using full dimensional similarity, all these dimensionless groups need to be held constant. This is normally impossible due to the small number of

**Table 3** Summary of Controlling Groups for Granulation Rate Processes

Rate process	Controlling groups	Key formulation properties	Key process parameters
Wetting and nucleation	Dimensionless spray flux $\psi$ , dimensionless penetration time $\tau_p$	$t_p, \mu, \gamma \cos \theta, d_p, \varepsilon, \varepsilon_{tap}$	$V^{\&}, A^{\&}$ (influenced by nozzle design and position, no. of nozzles, and powder flow patterns)
Growth and consolidation	Stokes deformation number $St_{def}$ , viscous Stokes number $St_v$ , liquid saturation $S$	$Y, \rho_g, \mu, \gamma \cos \theta, d_p, \varepsilon_{tap}$	$U_c$ (influenced by powder flow patterns; see Table 2)
Attrition and breakage	Stokes deformation number $St_{def}$	$K_c, H, Y, \rho_g, \mu, \gamma \cos \theta, d_p, \varepsilon_{tap}$	$U_c, L, u - u_{mf}$

degrees of freedom and the large number of constraints. In particular, for regulatory reasons it is usually not possible to change formulation properties during scale-up except during the very early stages of process development. This leaves only a relatively small number of process parameters as degrees of freedom.

Therefore, a partial similarity approach for scale-up is recommended. The general steps are

1. Maintain similar geometry throughout the scale-up process. For most of the pharmaceutical granulation equipment, this can be achieved from either 10 or 25 L nominal batch size to full scale. Be wary, however, in some cases key geometric parameters do vary with scale on a particular design, e.g., relative chopper size, relative fill height. Manufacturers should be lobbied hard to provide geometrically similar designs at all scales.
2. Set key dimensionless groups to maintain similar powder flow during scale-up. In particular, avoid changes of flow regime during scale-up that make maintaining granule attributes during scale-up impossible.
3. Use your experience and an understanding of your process to decide which product attributes are the most important, and which granulation rate process is most dominant in controlling these attributes. This is difficult to do a priori, but with good characterization of your formulation and process, the regime map approaches described earlier are very useful.
4. Use your remaining degrees of freedom in the choice of process parameter values to keep the most important one or two rate process dimensionless groups constant.

This approach is most easily demonstrated on a particular type of equipment (Section 5 for fluidized beds and Section 6 for high-shear mixers).

#### **4. SCALE-DOWN, FORMULATION CHARACTERIZATION, AND FORMULATION DESIGN IN PHARMACEUTICAL GRANULATION**

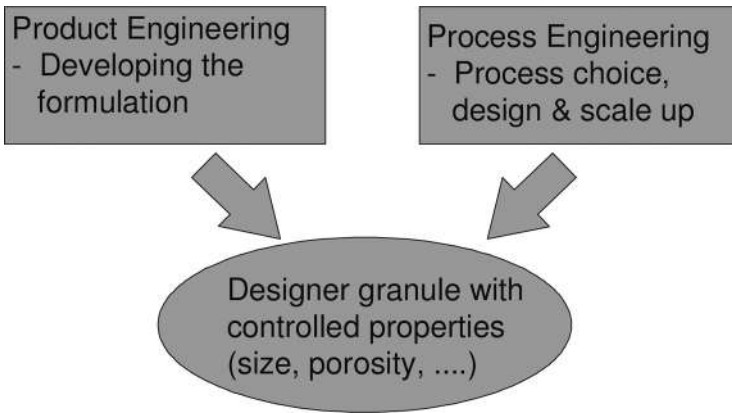
In the development of a new pharmaceutical product, important decisions about the manufacturing process are made with a few grams or tens of grams of formulation. To provide, the drug product for clinical trials and the final design at large scale, granulations are often conducted at several laboratory- and pilot scales as well. Typical nominal batch sizes are 1, 10, 25, and 65 L scaling to commercial operation at 300 or 600 L.

Small-scale granulations up to 1 L are often done by hand, and certainly performed in equipment that is very different from the equipment that will be used for scales from 10 L and larger. At this level, the general scale-up approach described in Section 3.4 does not hold. How do we scale down to make the best use of data from granulation of these small amounts?

The key is to consider granulation as a particle design process (Fig. 12). During scaling up from 10 L, formulation properties cannot be varied. Only process parameters can be used to keep key granule attributes in the target range. Therefore, very small-scale-experiments should target major formulation design decisions and attempts to mimic completely different geometries at larger scale should be avoided.

Table 3 summarizes key formulation properties that should be measured. Most of these require relatively small amounts of material and can be measured at this





**Figure 12** Granulation as an example of particle design. Both formulation properties and process parameters influence granule attributes.

level. By using these data to help estimate key controlling groups for the granulation rate processes in the larger-scale equipment, appropriate changes to the formulation can be made. This avoids major headaches at a later stage. Good communication between the technologists who design the formulations and the process engineers who scale the process and transfer the product to manufacturing is an essential part of this paradigm.

Some of the questions that can be addressed at this stage of formulation development and scale-up include:

1. Wetting and nucleation
  - Contact angle: Are the active and all the excipients easily wetted by the liquid binder?
  - Drop penetration time: Is the liquid phase too viscous, or the particle size too small to achieve fast drop penetration?
2. Growth and consolidation
  - What is the dynamic yield stress of the formulation?
  - How much liquid binder is required for granule growth?
  - What is the likely growth regime?
  - What range of granule density is likely?
3. Attrition and breakage
  - Will extensive granule breakage occur in the granulator?
  - What are dry granule strength (fracture toughness) and porosity?
  - Are attrition and dust formation during handling likely?
4. Downstream processing issues
  - Does the formulation compress well for tableting?
  - Can the desired dissolution profiles be met?

Details of how to measure key formulation properties are described in more detail in Litster and Ennis (5).

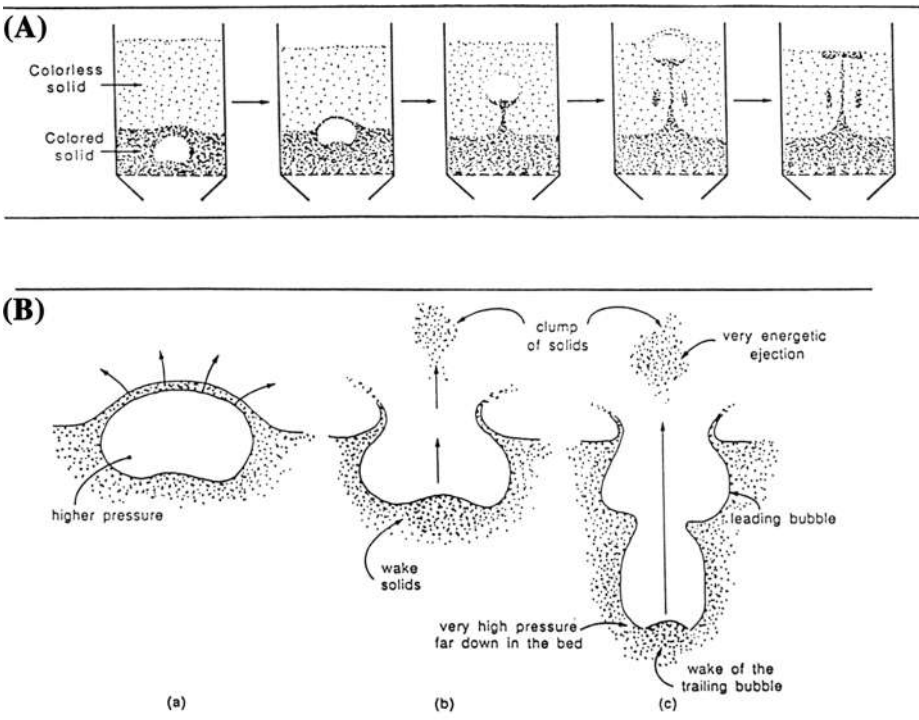
## 5. SCALE-UP OF FLUIDIZED BED GRANULATORS

There are many different variations of fluidized bed granulators including bubbling fluidized bed, draft tube fluidized beds, and spouted beds (5). However, in this section, we limit ourselves only to the scale-up of the most commonly used fluidized bed granulator, i.e., bubbling fluidized bed granulator. In particular, as most fluidized bed granulators used in the pharmaceutical industry are operated in batch mode, we will concentrate on the scale-up of batch bubbling fluidized bed granulators.

### 5.1. Bed Hydrodynamics and Scale-Up

Particle growth in a fluidized bed is closely related to the particle mixing and the flow pattern in the bed. This dictates that the hydrodynamics of the scaled bed should be the same as the small unit, i.e., hydrodynamic similarity. Basic fluidized bed hydrodynamics are described in Chapter 9.

In bubbling fluidized beds, bed expansion, solids mixing, particle entrainment, granule growth, and attrition are intimately related to the motion of bubbles in the bed (Fig. 13). The volume flow rate of bubbles in the bed  $Q_b$ , the bubble size  $d_b$ , and the bubble rise velocity  $u_b$  are the key parameters that characterize the bubbly flow. There are numerous correlations relating these bubble parameters to process conditions [see, for example, Kunii and Levenspiel (13) and Sanderson and Rhodes (14)]. In general,  $Q_b$  is a strong function of the excess gas velocity  $u - u_{mf}$ . Growing granules are usually Geldart type B powders, or perhaps type A powders at the start of the batch. For group B powders,  $d_b$  increases with bed height and is a function of



**Figure 13** Effect of bubbles on (A) solids mixing and (B) solids entrainment. (From Ref. 13.)

excess gas velocity. The bubble-rise velocity is directly related to  $d_b$ . For the simplest models for group B powders we can write

$$Q_b = (u - u_{mf})\pi D_F^2 \quad (5.1)$$

$$u_b = 0.71\sqrt{gd_b} \quad (5.2)$$

$$d_b \propto (u - u_{mf})^{0.4} L^{0.8} \quad (5.3)$$

Thus, the excess gas velocity  $u - u_{mf}$  and the bed height  $L$  are the key process parameters that control bubbling behavior in the bed.

Several rules exist for scaling up a bubbling fluidized bed under the condition of hydrodynamic similarity. Fitzgerald and Crane (15) proposed that the following dimensionless numbers be kept constant during scale-up:

- Particle Reynolds number based on gas density  $(d_p u \rho_G) / \mu$
- Spolid particle to gas density ratio  $\rho_s / \rho_G$
- Particle Froude number  $u / (g d_p)^{0.5}$
- Geometric similarity of distributor, bed, and particle  $L / d_p$

where  $d_p$  is the particle diameter,  $u$  is the fluidization velocity (superficial gas velocity),  $\mu$  is the viscosity of fluidizing gas,  $\rho_G$  is the density of fluidizing gas,  $g$  is the gravitational acceleration, and  $L$  is the fluidized bed height.

In this approach, experiments on the smaller scale are performed with model materials, i.e., model gas (different from the larger-scale one) and model solid particles (different particle density, size, and size distribution). For readers interested in following Fitzgerald's scale-up rules, a detailed calculation procedure can be found in Kunii and Levenspiel's book (13), illustrated with an example.

In a series of publications, Glicksman et al. (16–18) divided the scale-up into two regimes, namely, inertia-dominated and viscous-dominated flow regimes. In viscous-dominated flow regime, where particle Reynolds number based on fluid density is  $\leq 4$ , i.e., when, the  $(d_p u \rho_G) / \mu \leq 4$ , dimensionless numbers that need to be kept constant are

$$\frac{u}{(g d_p)^{0.5}}, \frac{d_p u \rho_s}{\mu}, \frac{L}{d_p}, \frac{D_F}{d_p}, \phi, \text{ particle size distribution, bed geometry} \quad (5.4)$$

where  $D_F$  is the fluidized bed diameter.

In contrast, in inertia-dominated flow regime,  $(d_p u \rho_G) / \mu \geq 400$ , scale-up of the process demands that the following dimensionless numbers are kept constant:

$$\frac{u}{(g d_p)^{0.5}}, \frac{\rho_G}{\rho_s}, \frac{d_p u \rho_s}{\mu}, \frac{L}{d_p}, \frac{D_F}{d_p}, \phi, \text{ particle size distribution, bed geometry} \quad (5.5)$$

In the intermediate region, where  $4 \leq (d_p u \rho_G) / \mu \leq 400$ , both the viscous and the inertial forces are important to the fluid dynamics, and all the dimensionless numbers for the two regions mentioned earlier will need to be kept constant during scale-up, i.e.,

$$\frac{\rho_s \rho_G d_p^3 g}{\mu^2}, \frac{u}{(g d_p)^{0.5}}, \frac{\rho_G}{\rho_s}, \frac{L}{d_p}, \frac{D_F}{d_p}, \phi, \text{ particle size distribution, bed geometry} \quad (5.6)$$

Experimenting with only ambient air and particles made of the same material but different sizes, Horio et al. (19,20) developed what has been lately defined as the simplified scaling law. They demonstrated that, with similar bed geometry (ratio of bed height to diameter), using particles of different mean sizes but the same distribution characteristics, and operating the bed in proportional superficial gas velocities would ensure that the hydrodynamic conditions of the two beds remain similar. Expressed in mathematical terms

$$\begin{aligned} u_2 - u_{mf,2} &= \sqrt{m}(u_1 - u_{mf,1}) \\ u_{mf,2} &= \sqrt{m}u_{mf,1} \\ m &= \frac{L_2}{L_1} \end{aligned} \quad (5.7)$$

bed geometry

where 1 and 2 refer to the small-scale and large-scale beds, respectively.

Experimental results from Roy and Davidson (21) suggest that when  $(d_p u \rho_G) / \mu < 30$ , the criteria of Horio et al. (19,20) are sufficient to give similarity in behavior. However, when  $(d_p u \rho_G) / \mu > 30$ , the more restrictive approach of Fitzgerald and Crane has to be used.

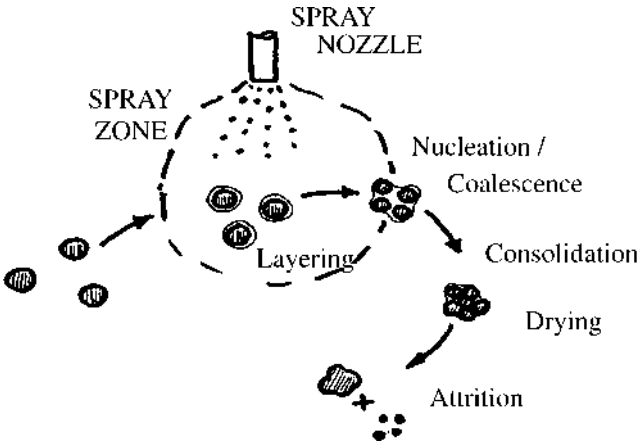
Unfortunately, few of the previously mentioned scaling rules for bubbling fluidized beds have been strictly followed for the scaling up of fluidized bed granulators. This is largely because the scaling rules require model materials to be used at the smaller scale, whereas in pharmaceutical granulation, the formulation is unchanged during scale-up. However, the simplified rules presented by Horio combined with our understanding of granulation rate processes do provide some guide.

## 5.2. Granulation Rate Processes in Fluidized Beds

Figure 14 shows the rate processes occurring during fluidized granulation. Wetting, nucleation, and layered growth occur in the spray zone of the fluidized bed. Most consolidation and coalescence also occur in or near the spray zone because fluidized bed granulators are also driers. The drying process “freezes” the granule structure and prevents further growth. Thus, good design of the spray zone is very important and liquid flow rate is a critical process parameter. Beds should be designed to keep dimensionless spray flux low (drop-controlled regime). If this is not done, the formation of large clumps leads to rapid wet quenching and defluidization with likely loss of the batch. Figure 15 shows how the product granule size distribution is closely related to the design of the spray zone. The  $x$ -axis variable (spray surface area per mass in granulator) is closely related to our definition of dimensionless spray flux.

Due to the simultaneous drying, our consolidation and growth models for near-elastic granules is usually appropriate and the viscous Stokes number is a key controlling group [Eq. (3.11)]. This model predicts that in batch granulation, granules will grow toward a maximum size corresponding to the critical Stokes number and transition to the coating regimes (e.g., Fig. 10). The average and maximum granule collision velocities are set by the flow of bubbles in the fluid bed and are a function of bubble velocity and size (Table 3).

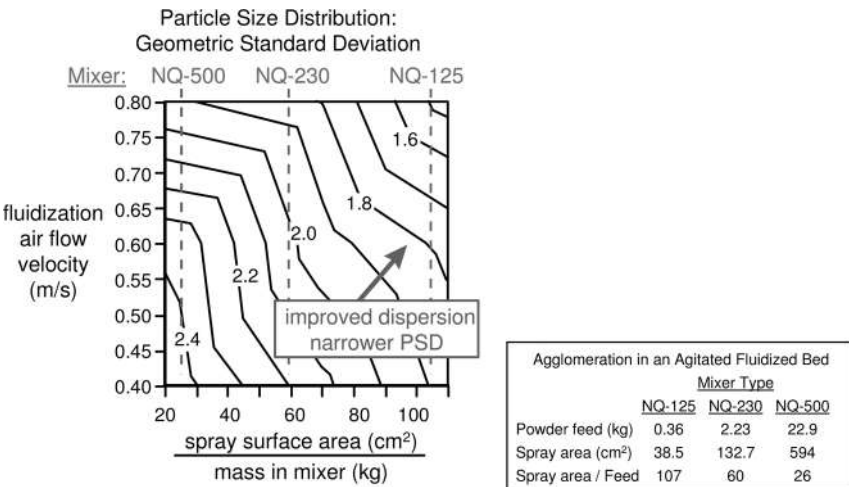
Fluidized beds produce porous granules because the consolidation time is limited to granule drying time, which is of the order of seconds, rather than minutes.



**Figure 14** Important granulation processes in the fluidized bed. (From Ref. 5.)

Thus, process changes that reduce drying time (higher bed temperature, lower liquid flow rate, and smaller drop size) will decrease granule density (increase granule porosity). Increasing the liquid binder viscosity decreases granule voidage by increasing the resistance of the granule to deformation.

Dry granule attrition in the fluid bed is an important source of fines. Eq. 3.14 quantifies the attrition rate in terms of granule properties and process conditions (Fig. 11). Increasing fluid bed height increases both consolidation and attrition for two reasons: (1) it increases the effective “fluid” pressure on granules in the bed and (2) it increases the average bubble size in the bed, leading to more vigorous mixing and higher-velocity granule collisions.



**Figure 15** Geometric standard deviation of granule size in an agitated fluid-bed granulator as a function of gas fluidization velocity and binder dispersion measured using spray surface area to mass in mixer. (From Ref. 10.)

### 5.3. Suggested Scaling Rules for Fluid Bed Granulators

Given this understanding of fluidized bed hydrodynamics and granulation rate process, we suggest the following guidelines for scaling fluidized bed granulators:

1. Maintain the fluidized bed height constant. Granule density and attrition rate increase with the operating bed height

$$L_2 = L_1 \quad (5.8)$$

2. If  $L$  is kept constant, then batch size scales with the bed cross-sectional area:

$$\frac{M_2}{M_1} = \frac{D_{F,2}^2}{D_{F,1}^2} \quad (5.9)$$

3. Maintain superficial gas velocity constant to keep excess gas velocity, and therefore bubbling and mixing conditions similar:

$$\frac{Q_2}{Q_1} = \frac{u_2}{u_1} = \frac{D_{F,2}^2}{D_{F,1}^2} \quad (5.10)$$

Note that the scaling rules defined by Eqs. 5.8–5.10 are consistent with Horio's simplified scaling rules (Eq. 5.7).

4. Keep dimensionless spray flux constant on scale-up. This is most easily achieved by increasing the area of bed surface under spray (usually by increasing the number of nozzles). By doing this, the liquid flow rate can be increased in proportion to batch size without changing critical spray zone conditions. Thus, batch times at small and large scale should be similar:

$$V_2^{\&} = V_1^{\&} \quad (5.11)$$

$$\frac{A_{\text{spray},2}}{A_{\text{spray},1}} = \frac{D_{F,2}^2}{D_{F,1}^2} \quad (5.12)$$

5. Keep viscous Stokes number constant. By adhering to the scaling rules described earlier,  $St_v$  should automatically be similar at small and large scale leading to similar consolidation and growth behavior.

There are also some cautionary notes relating to the minimum scale for the laboratory scale studies. Slug flow, a phenomenon where single gas bubbles as large as the bed diameter form in regular patterns in the bed, significantly reduces solid mixing. It occurs in tall and narrow beds. Stewart (22) proposed a criterion for the onset of slugging

$$\frac{u - u_{mf}}{0.35\sqrt{gD_F}} = 0.2 \quad (5.13)$$

To ensure that the bed is operating in bubbling mode without risking slugging, the ratio in Eq. 5.13 must be kept below 0.2. In addition, both the bed height to bed diameter and the particle diameter to bed diameter ratios should be kept low. For pilot fluidized bed, the diameter should be  $> 0.3$  m.

To avoid the gas entry effect from the distributor (gas jet), there is also a requirement on minimum fluidized bed height. The jet length depends on the gas velocity and the size of the opening on the distributor. For the same opening size,

jet length increases with gas velocity through the hole; for a given gas velocity through the hole, small holes give shorter jets but are accompanied by a larger pressure drop across the distributor. Even at a superficial gas velocity as low as 0.2 m/sec with a hole size of 9.5 mm diameter, jet length as long as 0.6 m has been reported (23).

The amount of fluidization gas required to maintain constant fluidization velocity changes linearly with the cross-section area of the bed. However, for large fluidized beds, one of the major concerns is the even distribution of the fluidization gas across the whole area of the bed. In addition to the use of a plenum chamber and an even distribution of flow channels across the distributor, the distributor should be designed in such a way that the pressure drop across it is at least 20% of the total.

If these scaling rules are applied, there is a good chance to keep granule properties within the desired range on scaling. If fine tuning is needed at the large scale, minor adjustments to the liquid spray rate can be used to adjust granule properties, as all the granulation rate processes in fluidized beds are very sensitive to this parameter.

## 6. SCALE-UP OF HIGH-SHEAR MIXER GRANULATORS

Effective scale-up of mixer granulators is more difficult than in fluidized beds. There are several reasons for this:

- The geometric and mechanical design of mixer granulators varies enormously, as do the powder flow patterns in the mixer. There is no such thing as a generic high-shear mixer and caution is needed when transferring scaling rules from one design to another.
- Even with the same series from the same manufacturer, geometric similarity is not always maintained between different scales, e.g., impeller size in relation to bowl size.
- Powder flow in high-shear mixers is not fluidized and powder flow patterns are much harder to predict than in a fluidized bed.
- All three rate processes, i.e., wetting and nucleation, growth and consolidation, and breakage and attrition, are taking place simultaneously in the mixer granulator of all scales. However, the relative dominance of each of the rate processes can vary significantly on different scales of the same series, let alone in granulators of different series.

In this section, we will focus mainly on vertical shaft mixer, e.g., Fielder, Diosna designs. Some of the suggested approaches may be used with caution for other mixer designs.

### 6.1. Geometric Scaling Issue

For a simple vertical mixer design, the key dimensions are the impeller diameter  $D$ , which is usually equal to the bowl diameter, the chopper diameter  $D_c$ , and the fill height  $H_m$ . The dimensionless groups that need to be held constant for geometric similarity are

$$\frac{D_c}{D}, \frac{H_m}{D}$$

In addition, the shape and positioning of the impeller and chopper should be the same on scale-up. Unfortunately, manufacturers do not always adhere to these

rules. It is common for the absolute size of the chopper to be invariant, meaning its relative influence is much larger in the small-scale granulator.

Relative fill height is also often varied with scale. This often reflects the small-size batches required for early-stage clinical trials and the desire to maximize production rate (by maximizing batch size) at full scale. Varying relative fill height is very dangerous, as it can have a major impact on powder flow patterns.

## 6.2. Powder Flow Patterns and Scaling Issues

There are two flow regimes observed in a vertical shaft mixer granulator, namely, bumping and roping regimes (24). At low impeller speeds in the bumping regime, the powder is displaced only vertically as the blade passes underneath leading to a slow, bumpy powder motion in the tangential direction. There is almost no vertical turnover of the powder bed, as shown in Figure 16A.

At a higher impeller speed in the roping regime, material from the bottom of the bed is forced up the vessel wall and tumbles down at an angle of the bed surface toward the center of the bowl. There is both good rotation of the bed and good vertical turnover (Fig. 16B).

The transition from bumping to roping is due to a change in the balance between centrifugal force and gravity. The centrifugal force, which is caused by the rotational movement of the powder from the spinning of the blades, pushes the powder outward toward the wall of the bowl, while gravity keeps the powder tumbling back toward the center of the bowl from the buildup at the wall region. This balance between rotational inertia and gravity is given by the Froude number:

$$Fr = \frac{DN^2}{g} \quad (6.1)$$

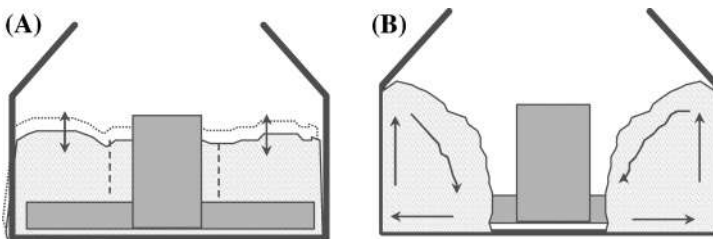
where  $N$  is the impeller speed and  $g$  is the gravitational acceleration.

When the Froude number exceeds a critical value, transition from bumping to roping takes place:

$$Fr > Fr_c \quad (6.2)$$

$Fr_c$  will be a function of relative fill height ( $H_m/D$ ), impeller design (size and geometry), and powder flow properties.

Roping flow is more difficult to achieve as relative fill height increases because the centrifugal force is only imparted to powder in the impeller region. This region becomes a smaller fraction of the total powder mass as fill height increases. Schaefer (25) also showed that impeller design had a significant effect on both  $Fr_c$  and bed turnover rate.



**Figure 16** Powder flow regimes in Fielder mixer granulators: (A) bumping and (B) roping.



Cohesive powders transfer to roping at lower values of  $Fr$  because momentum from the spinning impeller is more effectively transferred into the powder mass. Note that powder flow properties generally change with the addition of the liquid binder and, therefore, flow patterns will probably change significantly during a batch granulation.

Figure 17 shows dry lactose powder surface velocity data in a 25 L fielder granulator (24). In the bumping flow regime, the powder surface velocity increases in proportion to the impeller speed. In the roping regime, the surface velocity stabilizes and is less sensitive to impeller speed. In all cases, the surface velocity of the powder is only of order of 10% of the impeller tip speed. Knight et al. (26) showed that dimensionless torque  $T$  is a direct function of Froude number and effective blade height  $h_{\text{eff}}$ :

$$T = T_0 + kFr^{0.5} \quad \text{where } k = \beta \left( \frac{2h_{\text{eff}}}{D} \right)^a \quad (6.3)$$

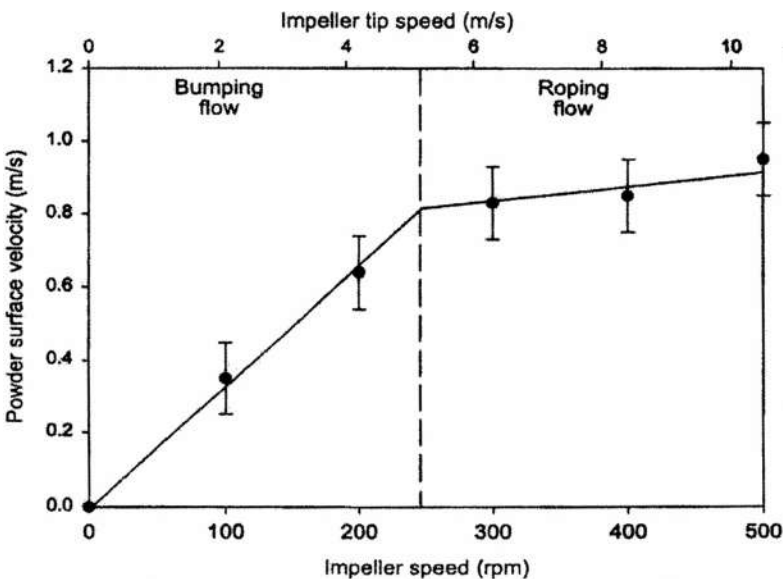
Thus, to maintain a similar powder flow pattern during scale-up, the Froude number should be kept constant, i.e.,

$$\frac{N_2}{N_1} = \sqrt{\frac{D_1}{D_2}} \quad (6.4)$$

In addition, the dimensionless bed height should also be kept constant, i.e., the same fraction of the bowl is filled at all scales:

$$\frac{H_{m,2}}{H_{m,1}} = \frac{D_2}{D_1} \quad (6.5)$$

Historically, mixer granulators have been more commonly scaled up using constant tip speed or constant relative swept volume (25,27). Maintaining constant



**Figure 17** Powder surface velocities as a function of impeller tip speed. (From Ref. 24.)

impeller tip speeds leads to the scaling rule:

$$\frac{N_2}{N_1} = \frac{D_1}{D_2} \quad (6.6)$$

This scale-up rule leads to  $Fr$  decreasing, as scale increases. Combined with the common practice of overfilling full-scale granulators, this approach to scaling can often lead to a change in operating regime from roping to bumping on scale-up.

The constant swept volume approach to scale-up was introduced partly to account for variations in geometry on scale-up. The relative swept volume is defined as

$$V_{\text{R}}^{\&} = \frac{V_{\text{imp}}^{\&}}{V_{\text{mixer}}} \quad (6.7)$$

where  $V_{\text{R}}^{\&}$  is the relative swept volume,  $V_{\text{imp}}^{\&}$  is the rate of swept volume of impeller, and  $V_{\text{mixer}}$  is the mixer volume.

On scale-up,

$$V_{\text{R},1}^{\&} = V_{\text{R},2}^{\&} \quad (6.8)$$

This approach is useful for comparing granulators where geometry changes with scale. For geometrically similar granulators, Eq. 6.8 is equivalent to scale-up with constant tip speed (Eq. 6.6).

### 6.3. Granulation Rate Processes and Related Scaling Issues

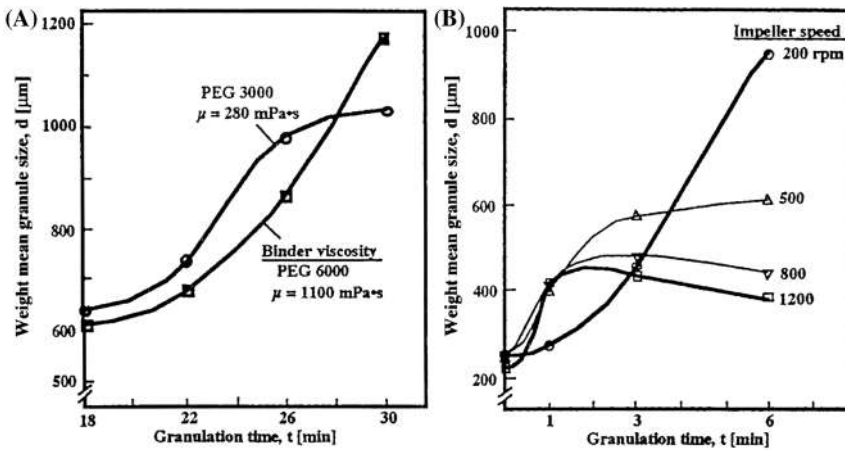
In high-shear mixer granulation, all three classes of rate process can have a significant effect on the granule size distribution. Section 3.1 describes conditions for good nucleation in the drop-controlled regime and uses examples from mixer granulation. For good nucleation, the granulator should be operated in the roping regime for good bed turnover and the dimensionless spray flux  $\psi_a$  should be kept low. This implies careful choice of the liquid flow rate, nozzle design, and positioning in the granulator.

To maintain similar nucleation behavior and equivalent liquid distribution, the dimensionless spray flux  $\psi_a$  should be kept constant on scale-up. If drop size from the full-scale nozzle is similar to the small scale, this implies

$$\frac{V_2^{\&}}{A_2^{\&}} = \frac{V_1^{\&}}{A_1^{\&}} \Rightarrow \frac{V_2^{\&}}{V_1^{\&}} = \frac{A_2^{\&}}{A_1^{\&}} \quad (6.9)$$

A common scale-up approach is to keep the same total spray time and still use a single nozzle at large scale. Thus,  $V^{\&}$  is proportional to  $D^3$ . Despite the fact that the powder area flux will increase slightly with scale, this approach generally leads to a substantial increase in dimensionless spray flux. To keep dimensionless spray flux constant, multiple spray nozzles or longer spray times should be used at a large scale.

It should be noted that consolidation, growth, and breakage processes are controlled by  $St_{\text{def}}$ . This can lead to quite complicated growth behavior in mixer granulators. Figure 18 illustrates some of this complex behavior (27). Both decreasing liquid viscosity and increasing impeller speed increase the rate of granule growth but decrease the final equilibrium granule size. Both these effects increase  $St_{\text{def}}$ . In the early stage of granulation, this increases the probability of successful coalescence. However, as the granules grow, the critical value of Stokes number for breakage may be exceeded—at least near the impeller blade leading to a balance of breakage and growth and an equilibrium granule size. This example also highlights that most



**Figure 18** Variations in granule growth rate and extent of growth in a mixer granulator with changes to (A) binder viscosity and (B) impeller speed. (From Ref. 27.)

high-shear mixers have a very wide range of collision velocities in different parts of the bed. Granule coalescence will occur in regions of low collision velocity, while breakage and consolidation are more likely near the impeller. To properly quantify and predict this behavior, we need more sophisticated models that divide the granulator into at least two regions and incorporate better understanding of powder flow than we currently have.

Nevertheless, we can make some intelligent comments with regard to scale-up. In a mixer granulator, the maximum collision velocity for a granule will be of the order of the impeller tip speed. To maintain constant  $St_{\text{def}}$ , the impeller tip speed should be kept constant, i.e., Eq. 6.6. If a constant  $Fr$  rule is used (Eq. 6.4),

$$\frac{St_{\text{def},2}}{St_{\text{def},1}} = \frac{U_{c,2}^2}{U_{c,1}^2} = \frac{N_2^2 D_2^2}{N_1^2 D_1^2} = \frac{D_2}{D_1} \quad (6.10)$$

Thus,  $St_{\text{def}}$  increases with scale. This will lead to an increase in the maximum achievable granule density and a decrease in the maximum achievable particle size. The actual granule density and size may also depend on the kinetics of consolidation and growth and are difficult to predict without more sophisticated quantitative modeling. As such, the variation in  $St_{\text{def}}$  with scale potentially leads to changes in granule attributes that are difficult to predict.

The liquid saturation  $s$  (Eq. 3.7) should be kept constant on scaling. This implies a similar liquid content on a kilogram per kilogram dry powder basis provided the granule density does not change with scale. For operation in the steady growth regime, this is a reasonable assumption. However, for operation in the induction growth regime the change in density with scale is harder to predict.

#### 6.4. Recommended Scaling Rules and a Case Study Example

The complexity of powder flow and granulation rate processes makes it impossible to recommend a single definitive set of scaling rules. It is important to know which granule attribute is of most importance during scaling and the main granulation rate process that controls this attribute.

Overall, we recommend the following approach:

1. Keep granulators geometrically similar during scale-up where manufacturer's designs permit. In particular, keep dimensionless fill height constant during scale-up (Eq. 6.5).
2. To ensure similar powder mixing, keep Froude number constant during scale-up by adjusting the impeller speed according to (Eq. 6.4). At the very least, make sure  $Fr > Fr_c$  at all scales.
3. To achieve good binder distribution,  $\psi_a$  should be kept constant on scale-up. This is likely to mean multiple spray nozzles at the large scale to give sufficient spray zone area (Eq. 6.9).
4. To keep  $St_{def}$  constant for consolidation, breakage, and growth, constant impeller tip speed should be maintained. This is in conflict with scaling rule 2 mentioned earlier. Scale-up with constant tip speed is possible, provided that at large scale  $Fr > Fr_c$ .
5. Spray time during the batch and total batch time scaling rules require a sound understanding of how the kinetics of growth and consolidation vary with scale. We do not know these rules yet, and they are likely to be different for operation at different growth regimes. As a starting point, keeping batch times constant during scaling is probably reasonable provided this does not conflict with other scaling rules (especially rule 3 mentioned previously).

Conflicting scale-up goals lead us to consider more sophisticated operating strategies at a large scale including programming impeller speed to change during the batch operation. For example, begin the granulation with high impeller speed (constant  $Fr$ ) to induce good dry powder turn over. This helps ensure good wetting and nucleation at the beginning of the batch when it is most important. Later, reduce the impeller speed to give a similar tip speed to smaller-scale operation to control granule density or size. As the powder mass is now wet, it will be more cohesive and operation above the critical Froude number for rolling flow will be easier to maintain. and Ennis (5) give a case study for scale-up of a lactose granulation that is useful for illustrating these scaling rules and conflicts. It is represented in the next section.

#### 6.4.1. Scale-Up of a Lactose Granulation from 25 to 300 L

A lactose-based granulation in a 25 L granulator has given granules with acceptable properties. The operating conditions for the 25 L granulator are summarized as follows:

Parameter	Value
Nominal volume (L)	25
Powder charge (kg)	5
Impeller speed (rpm)	330
Spray time (min)	8
Drop size ( $\mu\text{m}$ )	100
$\varepsilon_{min}$	0.3
$W$	0.15
$V^{\otimes}$ ( $\text{m}^3/\text{sec}$ )	$1.6 \times 10^{-6}$
Spray width $W$ (m)	0.13
Powder surface velocity (m/sec)	0.85
$\psi_a$	0.22

The dimensionless spray flux  $\psi_a$  was calculated by

$$\psi_a = \frac{3V_2^{\&}}{2A_2^{\&}d_d} \quad (6.11)$$

This granulation is to be scaled to 300 L using the following rules and heuristics:

- Keep  $Fr$  constant
- Keep spray time constant
- Spray from a single nozzle at large scale.

How do  $\psi_a$  and  $St_{\text{def}}$  change on scale-up? What are the implications from granulation rate processes at full scale?

Scaling to 300 L granulation:

Assuming geometric similarity,

$$D_2/D_1 = 12^{1/3}$$

Keeping  $Fr$  constant,

$$N_2 = (D_1/D_2)^{0.5} N_1 = 218 \text{ rpm}$$

Assuming spray width scales with impeller diameter,

$$W_2 = (D_2/D_1)W_1 = 0.3 \text{ m}$$

powder surface velocity scales with tip speed,

$$v_2 = (D_2N_2/D_1N_1)v_1 = 1.28 \text{ m/sec}$$

Keeping spray time constant with one nozzle,

$$V_2^{\&} = 12V_1^{\&}$$

Thus, the dimensionless spray flux at 300 L is

$$\psi_{a,2} = \frac{3V_2^{\&}}{2W_2v_2d} = \frac{3(12V_1^{\&})}{2(12^{1/3}W_1)12^{1/6}v_1d} = 3.41\psi_{a,1} = 0.75$$

There has been a substantial increase in  $\psi_a$  on scale-up taking the granulation from nearly drop controlled into the mechanical dispersion regime. This could result in a much broader granule size distribution at a large scale. A similar spray flux could be achieved by using an array of four nozzles spaced at  $90^\circ$  intervals around the granulator (all positioned so the spray fan is at right angles to the direction of powder flow).

We cannot calculate the value of  $St_{\text{def}}$  because the dynamic yield stress  $Y$  for the lactose/binder system is not given. However, if we neglect changes in  $Y$  due to the larger strain rate, then  $St_{\text{def}}$  will increase as

$$St_{\text{def},2} = \frac{U_{c,2}^2}{U_{c,2}^1} St_{\text{def},1} = \frac{(D_2N_2)^2}{(D_1N_1)^2} St_{\text{def},1} = 2.3St_{\text{def},1}$$

There is a significant increase in  $St_{\text{def}}$  with scale-up that could impact on the granule density and maximum size. It is not possible to scale with constant

$St_{\text{def}}$  while simultaneously maintaining constant  $Fr$ . Scale-up summary data are given in the following table:

Parameter	25 L	300 L
Nominal volume (L)	25	300
Powder charge (kg)	5	60
Impeller speed (rpm)	330	218
Spray time (min)	8	8
Drop size ( $\mu\text{m}$ )	100	100
$\epsilon_{\text{min}}$	0.3	0.3
$W$	0.15	0.15
$V^{\&}$ ( $\text{m}^3/\text{sec}$ )	$1.6 \times 10^{-6}$	$19.2 \times 10^{-6}$
Spray width $W$ (m)	0.13	0.3
Powder surface velocity (m/sec)	0.85	1.28
$\psi_a$	0.22	0.75
$St_{\text{def}}/St_{\text{def}, 25 \text{ L}}$	1	2.3

## 7. CONCLUDING REMARKS

Scaling of granulators using the traditional chemical engineering dimensional analysis approach of complete similarity is not possible due to the complexity of the process and the constraints on formulation changes during scaling pharmaceutical processes. Nevertheless, scale-up using partial similarity that strives to keep some key dimensionless groups invariant is possible. It is very important to understand the powder flow phenomena in the granulator of choice and to maintain the same flow regime during scaling (bubbling vs. slugging, bumping vs. roping).

The second important requirement is to maintain constant key dimensionless groups that control the important granulation rate process of most interest during scale. This is somewhat easier to do in fluidized beds than in high-shear mixers.

Very small-scale tests, which have no geometric similarity to pilot-and full-scale tests should be used to focus on formulation design and measurement of key formulation properties that influence the granulation rate processes.

Insightful understanding of the granulation processes is essential for the identification of key variables and parameters for the dimensional analysis and scale-up considerations. While development of definitive mathematical models for the granulation processes is incomplete, the scaling approaches recommended in this chapter help reduce uncertainty during new product development and transfer to industrial sites.

## NOMENCLATURE

$A^{\&}$	area flux of powder through the spray zone
$d_d$	liquid drop size (diameter)
$d_i$	indentor diameter
$d_p$	particle or granule size
$d_b$	bubble size
$D_{\text{drum}}$	drum granulator diameter
$D$	impeller diameter of mixer granulators
$D_c$	chopper diameter of mixer granulators
$D_F$	Fluidized bed diameter

$Fr$	Froude number
$g$	gravitational acceleration
$H$	hardness of granules
$H_m$	fill height of mixer granulators
$L$	characteristic length of a fluidized bed
$K_c$	fracture toughness of granules
$M_1, M_2$	mass of particles in the fluidized bed
$m$	scaling ratio
$N$	impeller speed
$St_{def}$	Stokes deformation number
$S_{max}$	granule pore saturation
$t_p$	drop penetration time
$u$	superficial fluidization velocity
$u_1$	fluidization velocity on the smaller bed
$u_2$	fluidization velocity on the larger bed
$u_{mf,1}$	minimum fluidization velocity on the smaller bed
$u_{mf,2}$	minimum fluidization velocity on the scaled bed
$u_b$	bubble rise velocity
$U_c$	particle collision velocity
$V_R^{\&c}$	relative swept volume
$V_{imp}^{\&c}$	rate of swept volume of impeller
$V_{mixer}$	mixer volume
$V^{\&c}$	volumetric spray rate
$w$	liquid to solid mass ratio
$W$	spray zone width
$Y$	dynamic yield stress of granules
$\mu$	viscosity of binder
$\rho_g$	granule density
$\rho_G$	density of fluidizing gas
$\rho_s$	particle density
$\rho_l$	binder liquid density
$\theta$	solid liquid contact angle
$\gamma_{LV}$	liquid surface tension
$\delta$	dimensionless bubble space, defined as the ratio of bubble space over bubble radius
$\omega$	drum peripheral speed
$\omega_i$	impeller peripheral speed
$\omega_c$	chopper peripheral speed
$\psi_a$	dimensionless spray flux
$\varepsilon_{min}$	minimum porosity of granule
$\varepsilon_{tap}$	granule bed tap density

## REFERENCES

1. Hileman GA. Regulatory issues in granulation processes. Parikh DM, ed. Handbook of Pharmaceutical Granulation Technology. New York: Marcel Dekker, Inc., 1997.
2. Skelly JP, et al. Scaleup of immediate release oral solid dosage forms. Pharm Res 1993; 10:2–29.
3. Zlokarnik M. Dimensional Analysis and Scale-up in Chemical Engineering. Berlin: Springer-Verlag, 1991.
4. Munson BR, Young DF, Okiishi TH. Fundamentals of Fluid Mechanics. 2nd ed. New York: John Wiley & Sons, Inc., 1994.

5. Litster JD, Ennis B. *The Science and Engineering of Granulation Processes*. Dordrecht: Kluwer Academic Publishers, 2004.
6. Hapgood KP, Litster JD, Smith R. *AIChE J* 2003; 49(2):350–361.
7. Iveson SM, Wauters PAL, Forrest S, Litster JD, Meesters GMH, Scarlett B. *Powder Technol* 2001; 117(1,2):83–97.
8. Iveson SM, Beathe JA, Page NW. *Powder Technol* 2002; 127:149–161.
9. Ennis BJ, Tardos GI, Pfeffer R. *Powder Technol* 1991; 65:257.
10. Tardos GI, Irfran-Khan M, Mort PR. *Powder Technol* 1997; 95:245.
11. Evans AG, Wilshaw TR. *Acta Metall* 1976; 24:939.
12. Ennis BJ, Sunshine G. *Tribol Int* 1993; 26:319.
13. Kunii D, Levenspiel O. *Fluidization Engineering*. 2nd ed. Boston: Butterworth-Heinemann, 1991.
14. Sanderson J, Rhodes M. Hydrodynamic similarity of solids motion and mixing in bubbling fluidized beds. *AIChE J* 2003; 49:2317–2327.
15. Fitzgerald TJ, Crane SD. Cold fluidized bed modelling. *Proceedings of the International Conference of Fluidized Bed Combustion*. Vol. III. Technical Sessions, 1985:85–92.
16. Glicksman LR. Scaling relationships for fluidized beds. *Chem Eng Sci* 1984; 39:1373–1379.
17. Glicksman LR. Scaling relationships for fluidized beds. *Chem Eng Sci* 1987; 43:1419–1421.
18. Glicksman LR, Hyre M, Woloshun M. Simplified scaling relationships for fluidized beds. *Powder Technol* 1993; 77:177–199.
19. Horio M, Nonaka A, Sawa Y, Muchi I. A new similarity rule for fluidized-bed scale-up. *AIChE J* 1986; 32:1466–1482.
20. Horio M, Takada M, Ishida M, Tanaka N. The similarity rule of fluidization and its application to solid mixing and circulation control. *Proceedings of Fluidization V*. New York: Engineering Foundation, 1986:151–156.
21. Roy R, Davidson JF. Similarity between gas-fluidized beds at elevated temperature and pressure. *Proceedings of Fluidization V*. New York: Engineering Foundation, 1986: 293–299.
22. Steward PSB, Davidson JF. *Powder Technol* 1967; 6:61–80.
23. Werther J. Influence of the distributor design on bubble characteristics in large diameter gas fluidized beds. Davidson JF, Keairns DL, eds. *Fluidization*. New York: Cambridge University Press, 1978.
24. Litster JD, Hapgood KP, Kamineni SK, Hsu T, Sims A, Roberts M, Michaels J. *Powder Technol* 2002; 124:272–280.
25. Schaefer T. Ph.D. thesis, The Royal Danish School of Pharmacy, 1977.
26. Knight PC, Seville JPK, Wellm AB, Instone T. *Chem Eng Sci* 2001; 56:4457–4471.
27. Kristensen HG, Schaefer T. *Drug Dev Ind Pharm* 1987; 13:803.



# 17

## Sizing of Granulation

**Gurvinder Singh Rekhi and Richard Sidwell**

*Elan Drug Delivery Inc., Gainesville, Georgia, U.S.A.*

### 1. INTRODUCTION

Tablets are the most frequently administered solid oral dosage forms in contemporary practice. Tablets consist of a mixture of powders or granules that are compacted in the die of a tablet press. Even though the popularity of directly compressible materials has increased, many powders are granulated to overcome the difficulties in obtaining an acceptable tablet dosage form and meeting the product specifications. The most challenging task in a tableting process is to achieve a constant volume of homogenous mixture to flow into the tablet die cavity. Unfortunately, most powder materials do not have inherent flow properties. This, in turn, places demands on changing the physical characteristics of the powder or improving the design of the tablet press (1). Therefore, granulation becomes an integral part of a pharmaceutical process that attempts to improve powder flow characteristics.

The granule properties play a pivotal role in the final performance of a tablet; for example, granule size can affect the flowability and, hence, the average tablet weight and weight variation, and drying rate kinetics of wet granulations. The effect of granule size and size distribution on final blend properties and tablet characteristics is dependent on formulation ingredients and their concentration, as well as the type of granulating equipment and processing conditions employed. Therefore, granulation and sizing of granulation become critical unit operations in the manufacture of oral dosage forms (2,3). To some extent, the same requirements are necessary for capsule manufacture, especially when the drug is bulky or has poor flow properties, or in the newer high-speed capsule-filling machines, where limited compaction occurs.

Few materials used in the manufacture of pharmaceutical dosage forms exist in the optimum size, and most materials must be reduced in size at some stage during production. The advantages of sizing of granules in tablet formulation development are as follows:

1. Mixing and blending of pharmaceutical ingredients are easier and more uniform if the ingredients are of approximately the same size and distribution.
2. Improving color or active ingredient dispersion. Milling may reduce the tendency for mottling, and hence improve the uniformity of color from batch to batch.

3. Wet milling produces uniformly sized wet granules, which promotes uniform and efficient drying.
4. Improving uniformity of dosage units by virtue of uniformity of particle size distribution and reduction in the segregation of the mix.
5. Enhancing flow properties reduces the weight variation and improves content uniformity.
6. Increasing surface area due to particle size reduction may enhance the dissolution rate and thereby, the drug's bioavailability.
7. Reduction of dust, thereby reducing workers' exposure.

Size reduction alone is not the panacea for all tableting problems. There are some disadvantages to size reduction that may affect the final characteristics of a dosage form, such as degradation of the drug or a change in the polymorphic form as a result of the excessive heat generated, or increase in surface energies leading to agglomeration, and so on. Hence, in optimizing the manufacture of pharmaceutical dosage forms, it is important not only to characterize the formulation ingredients, but also to study their effect on the manufacturing process (i.e., whether a granulation should be milled and to what extent based on the final product specifications).

The objective of this discussion is to focus on sizing of granulation after drying in a wet granulation process. However, a process of wet milling for obtaining uniformly sized granules for uniform drying will also be addressed. A full discussion of the theories of comminution or equipment description is beyond the scope of this chapter. However, the text of this chapter will address the various types of equipment used in the size reduction process, their merits and demerits and the variables affecting the size reduction process, scale-up factors, and relevant case studies to be considered in the development and optimization of tablet and capsule manufacture.

## 2. THEORY OF COMMINUATION OR SIZE REDUCTION

Comminution, or size reduction, is the mechanical process of reducing the size of particles or aggregates. There is, as yet, only a basic understanding of the mechanism and quantitative aspects of milling (4,5). Reduction of particle size through fracture requires application of mechanical stress to the material to be crushed or ground. Materials respond to this stress by yielding, with consequent generation of strain. In the case of a brittle substance, complete rebound occurs on release of applied stress at stresses up to the yield point, at which fracture would occur. In contrast, plastic material would neither rebound nor fracture. The vast majority of pharmaceutical solids lie somewhere between these extremes and thus possess both elastic and viscous properties.

The energy expended by comminution ultimately appears as surface energy associated with newly created particle surfaces, internal free energy associated with lattice changes, and heat. For any particle, there is a minimum energy required which will fracture it; however, conditions are so haphazard that many particles receive impacts that are insufficient for fracture, and are eventually fractured by excessively forceful impact. As a result, most efficient mills use <1–2% of the energy input to fracture particles and to create new surfaces. The rest of the energy is dissipated in the form of heat from the plastic deformation of the particles that are not fractured, by friction, and in imparting kinetic energy to the particles. The greater the rate at which the force is applied, the less effectively the energy is utilized, and the higher is the proportion of fine material produced.

A flaw in a particle is any structural weakness that may develop into a crack under strain. The Griffith theory (4) of cracks and flaws assumes that all solids contain flaws and microscopic cracks, which increase as the applied force increases, according to the crack length and focus of the stress at the crack apex.

A *granule* is an aggregation of particles that are held together by bonds of finite strength, and the ultimate strength of a wet granule depends on the surface tension of the granulating liquid and capillary forces. After drying, granules develop stronger bonds owing to fusion and recrystallization of particles, and curing of adhesives or binding agent. The final strength of a granule depends on the base material, the type and the amount of granulating agent used, and the granulating equipment employed.

A granule or particle may be subjected to one or more of the following four forces during milling:

1. Shear (cutting forces)
2. Compression (crushing force)
3. Impaction (the direct, high-velocity collision force)
4. Tension (the force that works to elongate or pull a particle apart)

The mechanism by which sizing of dried granules occurs is similar to that of crystalline materials. Cleavage occurs at the weakest point or points in the granule and it could be at (2):

1. the binder–particle interface
2. the bridge of binder between the individual ingredient particles being granulated
3. flaws in the individual ingredient particles within the granules, or
4. a combination of any of these.

Granules held together with lower binding strength agents such as povidone will require less severe grinding conditions because the fractures take place primarily at the binder bridge or the binder–particle interface.

Although the milling process can be described mathematically (6–8), its theory has not been developed to the point at which the actual performance of a mill can be predicted quantitatively. Three fundamental laws (Kick's Law, Rittinger's Law, and Bond's Law) have been proposed to relate size reduction to a single variable, the energy input to the mill. None of the energy laws apply well in practice (9). Generally, laboratory testing is required to evaluate the performance of a particular piece of equipment; however, a work index and grindability index have been used to evaluate the mill performance (5). The efficiency of milling process is influenced by the nature of the force, as well as by its magnitude. The rate of application of force affects comminution because there is a lag time between the attainment of maximum force and fracture. Often, materials respond as a brittle material to fast impact, and as a plastic material to a slow force.

### 3. PROPERTIES OF FEED MATERIALS AFFECTING THE SIZING PROCESS

The milling or sizing process is affected by a variety of factors and has a direct effect on the quality of the final product. The properties of feed material and the finished product specifications determine the choice of equipment to be used for the process of comminution. The properties of feed material include melting point, brittleness,

hardness, and moisture content. The desired particle size, shape, and size distribution must also be considered in the selection of milling equipment.

Materials can be classified as hard, intermediate, soft, or fibrous materials (e.g., glycyrrhiza and rauwolfia) based on Moh's Scale. Fibrous materials require cutting or chopping action and usually cannot be reduced in size effectively by pressure or impact techniques. Before selecting and optimizing a size reduction process one needs to know the properties of the material and the characteristics of a mill. The important material properties (5,10) are as follows:

1. *Toughness*: The material's resistance to the propagation of cracks. Reduction of the particle size of tough material is difficult, but can sometimes be made easier by cooling the material, thereby diminishing its tendency to exhibit plastic flow, and making it more brittle.
2. *Brittleness*: The opposite of toughness. Size reduction poses no problems except if the amount of fines is to be controlled.
3. *Abrasiveness*: This is an important factor because abrasive materials can wear mill parts and screens; hence, metal contamination may be a problem.
4. *Cohesive/adhesiveness*: Particles sticking together or to machine surfaces are often dependent on moisture content and particle size. Problems with moisture content can be mitigated by drying the material or avoided by using a wet size reduction process.
5. *Melting point*: This is critical because considerable heat is generated in size reduction. High temperatures generated can cause melting of the drug, blinding of screen, or can degrade heat-sensitive materials.
6. *Agglomeration tendency*: This tendency can be counteracted by drying the material, either before or during the size reduction operation. In some cases, mixing with other ingredients during milling might be helpful. Generally, materials having a strong tendency to agglomerate are wetted prior to milling.
7. *Moisture content*: A moisture content above 5% can often lead to agglomeration or even liquefaction of the milled material. Hydrates will often release their water of hydration under high temperatures and may require cooling or low-speed milling.
8. *Flammability and explosiveness*: A measure of how readily a material will ignite or explode. Explosive materials must be processed in an inert-gas atmosphere.
9. *Toxicity*: This has little influence on the selection of the mill itself; however, it must be considered in determining operator safety, containment, and setup for this type of material.
10. *Reactivity*: The possibility of materials chemically reacting with the materials of construction of the mill (including liners and gaskets) and cleaning solutions must be considered.

#### 4. CRITERIA FOR SELECTION OF A MILL

The selection of equipment is determined by the characteristics of the material, the initial particle size, and the degree of the desired size of the milled product, that is, coarse, medium, or fine.

The criteria for selection of a mill include the following (4):

1. *Properties of feed material*: Size, shape, moisture content, physical and chemical properties, temperature sensitivity, grindability, and material compatibility
2. *Product specifications*: Size, particle size distribution, shape
3. *Versatility of operation*: Wet and dry milling, rapid change of speed and screen, safety features
4. *Scale-up*: Capacity of the mill and production rate requirements
5. *Repeatability*: Ability to meter material to the mill to insure consistent process
6. *Dust control*: Loss of costly drugs, health hazards, contamination
7. *Sanitation*: Ease of cleaning (clean in place, CIP) and sterilization (sterilization in place, SIP)
8. *Auxiliary equipment*: Cooling system, dust collectors, forced feeding, stage reduction
9. *Batch or continuous operation*
10. *Economic factors*: Equipment cost, power consumption, space occupied, labor cost

After consideration of the foregoing factors for a specific milling problem, it is suggested that a variety of mills should be evaluated for optimum product results such as shape of granules and/or scalability from laboratory to production. In addition to the standard adjustments of the milling process (e.g., screen, speed, rotor design, feed rate), other techniques of milling may be considered for special materials. Hygroscopic materials can be milled in a closed system supplied with dehumidified air. As the bulk of the energy used in milling is converted into heat, heat-sensitive materials, or hard materials that build up in the milling chamber may melt, decompose, or explode. A two- or multistep milling process can be used for harder and difficult-to-grind materials. Materials can be milled using a coarser screen, and the material can then be recycled by screening the discharge and returning the oversized material for a second milling (closed circuit mill). Alternatively, one may chill the air or gas (carbon dioxide or nitrogen) that transports the product, cool the product prior to processing, or cool the comminuting chamber through which the product passes. A chiller is necessary for all of these options and will add to the cost of processing (11). If this not sufficient to embrittle the material, it may be fed to the mill simultaneously with dry ice.

## 5. CLASSIFICATION OF MILLS

The majority of size reduction equipment may be classified according to the way in which forces are applied; namely, impact, shear, attrition, and shear-compression (Table 1). A given mill may operate successfully in more than one class: a hammer mill may be used to prepare a 16-mesh granulation and to mill a crystalline material to a 120-mesh powder. The mills used for size reduction of the granules can be divided into two primary categories based on the energy input into the process. Even though there are several high-energy mills available for size reduction, only a few are used in the pharmaceutical industry for the wet or dry sizing process. Milling is an extremely inefficient unit operation with only 1–2% of the applied energy being utilized in the actual size reduction. Milling efficiency is dependent on the characteristics of the material used and the type of mill employed.

**Table 1** General Characteristics of Various Types of Mills

Mechanism of action	Example	Product size	Type of material	Not used for
Impact	Hammer mill	Moderate to fine	Brittle and dry material	Fibrous, sticky, low-melting substances
Shear	Extruder and hand screen	Coarse	Deagglomeration, wet granulation	Dry material, hard, abrasive materials
Attrition	Oscillating granulator	Coarse to moderate	Dried granulation	Wet granulation, abrasive materials
Shear-compression	Conical screening mill	Moderate to coarse	Wet, dry granulation	Abrasive materials

## 5.1. Low-Energy Mills

### 5.1.1. Hand Screen

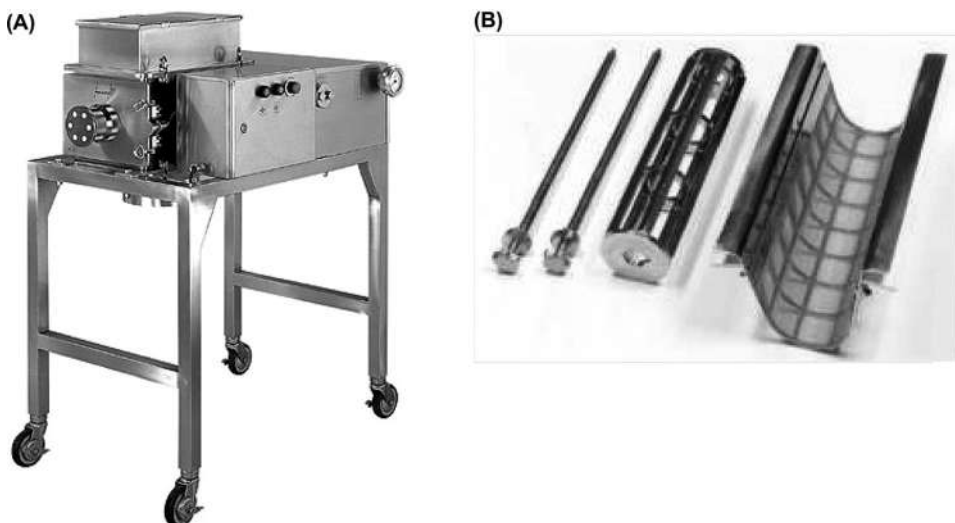
- Size reduction occurs primarily by shear.
- They are made of brass or stainless steel and consist of a woven wire cloth stretched in a circular or rectangular frame.
- They are available in sizes ranging from 4 to 325 mesh; however, for granulation, primarily mesh sizes from 4 to 20 are used.
- They are most widely used for sieve analysis or for size reduction of wet and dry granules in the early stages of formulation development.

### 5.1.2. Oscillating/Rotary Granulator

- They consist of an oscillating bar contacting a woven wire screen, and the material is forced through the screen by the oscillating-rotary motion of the bar (Figs. 1A and B).
- Size reduction is primarily by shear with some attrition
- Speed, rotary or oscillatory motion, and screen size are important variables to be considered during the sizing process.
- They are used primarily for size reduction of wet and dry granulations and, to some extent, for milling tablets and compacts that must be reprocessed.
- The narrow size distribution and minimum amount of fines are advantages during the size reduction of dry granulation (2).
- Heat-sensitive and waxy materials can be milled owing to the low heat generated during the sizing process.
- Low throughput rates and possible metal contamination from wearing down or broken screen are some of its limitations.

### 5.1.3. Extruder

- It is primarily used for continuous wet granulation.



**Figure 1** Oscillating granulator: (A) Frewitt MF line and (B) rotor, screen, and tensoning spindles.

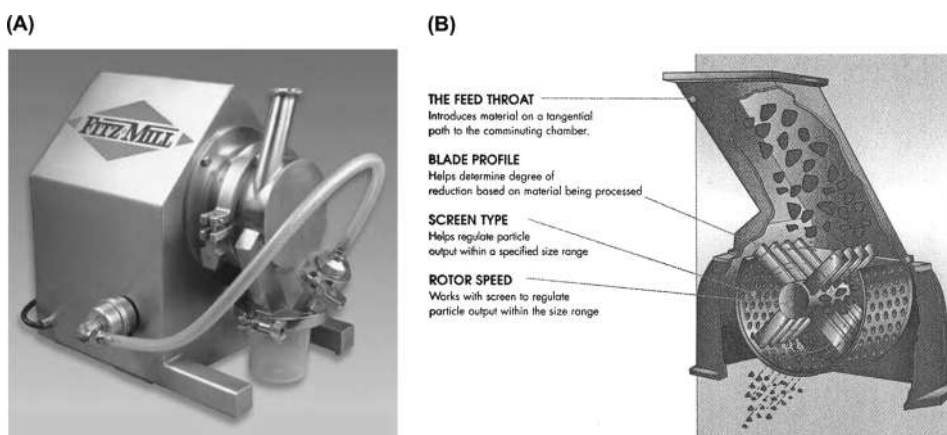
- Wet material is forced through a screen and the extruded material is dried in a tray or fluid bed dryer or can be spheronized to produce granules with a high degree of sphericity and then dried for controlled-release applications.
- Less dust generation and more uniform granules are some of the advantages.
- More information on extrusion may be found in [Chapter 11](#).

## 5.2. High-Energy Mills

### 5.2.1. Hammer Mill

The hammer mill is one of the most versatile and widely used mills in the pharmaceutical industry. The principle of size reduction in the hammer mill is one of high-velocity impact between the rapidly moving hammers mounted on a rotor and the powder particles (Figs. 2A and B). These mills can produce a wide range of particle sizes, even down to micrometer size. The particle shape, however, is generally sharper and more irregular than that produced by compression methods (5). The force imparted by the hammers and the screen opening size and shape control the degree of particle size reduction.

- They can be used for size reduction of wet or dry granulations and milling of raw materials.
- There is a wide range of interchangeable feed throats and variable feed screw systems available to optimize the feed rate (12).
- Hammers can rotate horizontally or vertically, based on the rotor configuration, and at variable speeds.
- Hammers can be fixed or free-swinging.
- Hammers with blunt or impact edges are preferred for pulverizing and knife or sharp edges are preferred for chopping or sizing of granules (12).
- Screen openings generally vary from 0.3 to 38 mm, with round or square perforations, diagonal or straight slots, or with a rasping surface.
- Feed rate and dryness of the granules are important variables relative to the material.
- Type of hammers, rotor speed, screen type, thickness, and opening size are important variables relative to the machine.



**Figure 2** Hammer mill: (A) Fitzmill model L1A and (B) principle of operation.



- Ease of setup, clean-up, minimum scale-up problems, and ability to handle a wide variety of size and type of feedstock are some advantages.
- Heat buildup, screen wear, and potential clogging of screens are some of the limitations.
- Integrated designs are available for dust containment.
- Examples include the Granumill and Fitzmill.

### 5.2.2. Conical Screening Mill

- It is effective for dry (deagglomeration–delumping) and wet milling of soft to medium hard materials.
- The comminution chamber consists of an impeller rotating at variable speed, imparting a compression or shear force inside a conical screen.
- The impeller imparts a vortex flow pattern to the feed material, and the centrifugal acceleration forces the particles to the screen surface and up the cone (360°) in a spiraling path (13) (Figs. 3A and B).
- The space between the impeller and the screen can be adjusted.
- The size and shape of the screen holes, screen thickness, impeller configuration, and mill speed are important variables.
- It is used for difficult-to-mill, heat-sensitive material and hard granules.
- Low heat and lower amounts of fines are produced compared with the hammer mill; hence, it produces a narrower particle size distribution.
- The impeller does not touch the screen; hence, chances of screen breakage and metal contamination are greatly reduced compared with an oscillating granulator.
- The dual action of conical screening mills (size reduction and mixing) makes this equipment more desirable than the use of traditional oscillators (14,15).
- Integrated designs are available that are attached to a high-shear granulator discharge, which provides a deagglomerated, lump-free product for the dryer (Fig. 4).
- Examples include the Comil, Glatt sieve GS or GSF, and FitzSiv.

### 5.2.3. Centrifugal-Impact Mills

Centrifugal-impact mills and sieves are useful to minimize the production of fine particles, because their design combines sieving and milling into a single operation. Unlike the conical screening mills, these consist of a nonrotating bar or stator which is fixed within a rotating sieve basket. This action produces a very low product agitation and impact; hence, no heat is generated. The particles that are smaller than the holes of the sieve can pass through the mill without comminution; however, the larger particles are directed by centrifugal force to impact the stator. Older designs are not preferred because the likelihood of sieve-to-stator contact can result in metal particulates in the product. Newer designs eliminate metal-to-metal contact. The Frewitt SG line (Figure 5) is an example of this type.

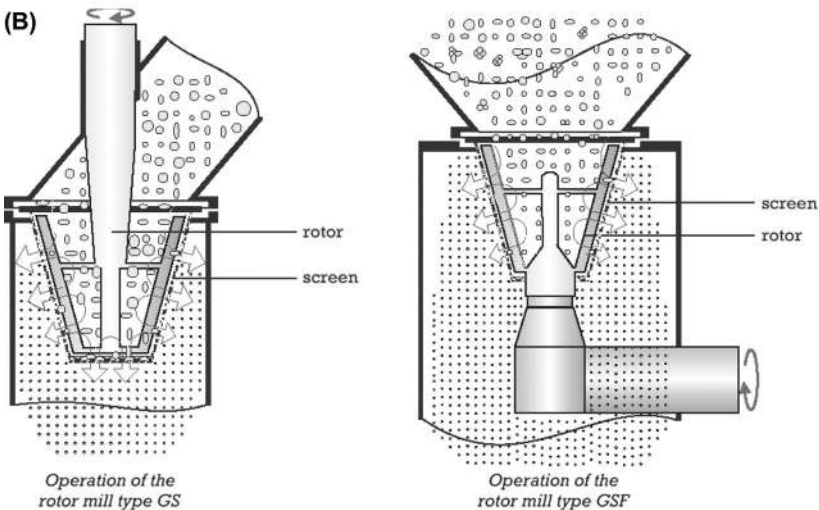
## 6. WET MILLING

The discussion so far has been focused on dry milling. These mills can also be used for wet milling or coarse milling. There are several reasons for wet milling, including the following (16):

(A)



(B)



**Figure 3** Conical-screening mill: (A) Glatt model GSF 180 and (B) principle of operation.

1. To increase surface area for more efficient drying
2. To improve size uniformity
3. To improve granule formation
4. To prevent large particles that will shatter to “fines” on dry milling
5. For further mixing or blending because ingredients are approximately of the same size

As discussed for low-shear mills, extruders can be used as a continuous wet granulation method. Wet milling is necessary with low-shear mixers, such as planetary, ribbon, or sigma mixers, but with high-shear mixers, the combination of high impeller speed and built-in choppers produces a product ready for drying. Also, integrated designs are available such that the wet milling step is no longer a separate operation.



**Figure 4** An integrated pharmaceutical manufacturing facility (high-shear granulator–conical screening mill–fluid bed drier).



**Figure 5** Centrifugal-impact mill: Frewitt SG Line.

Finally, there are continuous granulators available (M6 NICA granulator) for product applications that do not require extensive kneading treatment, and can be used for both batch and continuous operation. The wetted product is discharged in continuous stream through an adjustable opening in the turbine cover. A homogenous mix is produced in a few minutes and further milling may not be necessary.

## 7. VARIABLES AFFECTING THE SIZING PROCESS

### 7.1. Process Variables

As discussed in the introduction, the granule properties can dictate the properties of the final tablet. Some of the problems faced during the tableting process are flow of granules, maintaining uniform density in the granule bed, and the particle size distribution. Each of the stages of the granulation can be critical and can affect tableting. In addition to the wet granulation process, the sizing process can be critical for the particle size distribution that, along with the amount of fines, dictates the flow properties. These, in turn, influence the packing and density of the granules. Reproducibility of batches depends not only on the properties of the unmilled dry granules, but also on the mill and milling parameters. Finally, the dry-milling stage is important because of the excessive heat generated that might affect the stability of the final product.

The characteristics of the granules after size reduction depend mainly on the type of mill, impeller type and speed, screen size, and thickness.

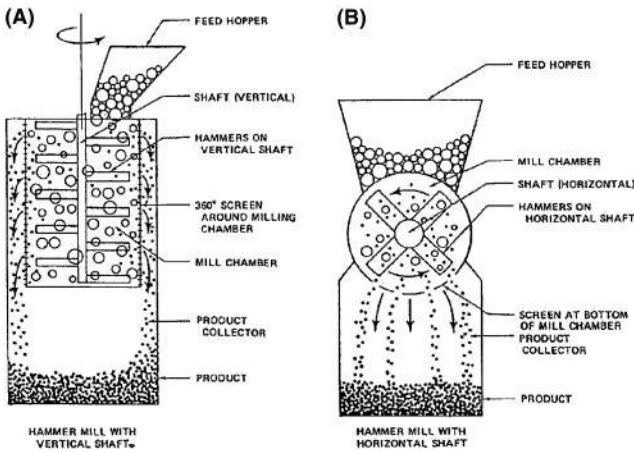
### 7.2. Type of Mill

The type of mill chosen can affect the shape of the granules and throughput. The shape of the milled granules can affect the flow properties. An impact mill produces sharp, irregular particles that may not flow readily, whereas an attrition mill produces free-flowing spheroidal particles. An oscillating granulator uses shear and attrition as the main mechanisms for size reduction. The granules produced are more spheroidal, because size reduction takes place by surface erosion. If the same material is subjected to impact by hammers in a hammer mill, the granules will shatter and cause irregularly shaped granules. If a conical screening mill is used for the same material for size reduction, it imparts some shear and some compression between the rotating impeller and the screen.

#### 7.2.1. Hammer Mill

There are a number of variables in a hammer mill that can influence comminution (12,17–19). The following section discusses five operating variables in detail:

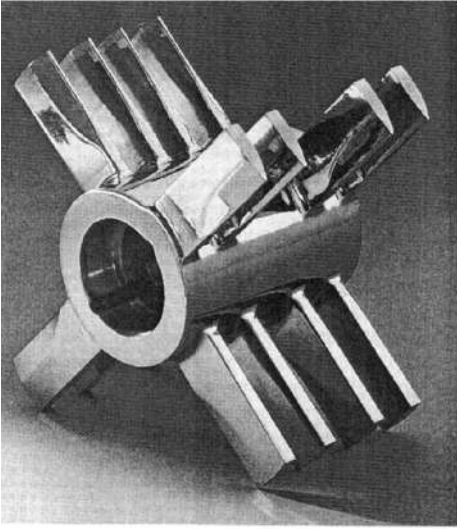
1. *Rotor shaft configuration*: The hammers may be mounted on a vertical or horizontal shaft (Figs. 6A and B). The vertical shaft mills (Stokes-Tornado mill) have feed inlets at the top and material is fed perpendicular to the swing of the hammers. In the case of horizontal shaft mills (Fitzpatrick-Fitzmill), the material is fed tangentially to the hammer swing. Rotor configuration can influence the particle size distribution of granules. In the vertical configuration, the screen is placed 360° around the hammers and this provides more screen open area and less time for the granules to stay in the milling chamber when compared with the horizontal shaft mills.



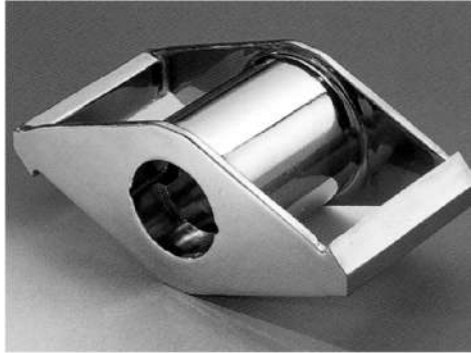
**Figure 6** Different types of hammer mills: (A) vertical shaft (B) horizontal shaft.

2. *Material feed rate:* The feed rate controls the amount of the feed material that enters the comminutor and prevents overfeeding (slugging) or underfeeding (starving) in the milling chamber. Although both affect the particle size distribution, overfeeding is relatively more detrimental. If the rate of feed is relatively slow, the product is discharged readily, and the amount of undersize material, or fines, is minimized. On the other hand, overfed material stays in the milling chamber for a longer time, because its discharge is impeded by the mass of material. This leads to a greater reduction of particle size, overloads the motor, and the capacity of the mill is reduced. The rule of thumb is to keep the feed rate equal to the rate of discharge. The feed rate can be controlled using variable-feed screws, vibratory feeders, or dischargers controlled by gravity. In addition to controlling the flow, the feed throat must allow the material to enter at a proper angle. There are more than 50 feed throat designs available that one needs to consider for optimizing the milling process. Most mills used in the pharmaceutical operations are designed so that the force of gravity is sufficient to give free discharge, generally from the bottom of the mill.
3. *Blade type:* Comminution is effected by the impact of the material with the fast moving blades and attrition with the screen. Generally, the blades of a hammer mill have a blunt or flat edge on one side and a sharp or knife-edge on the other side. The desired particle size range determines which blades to use. Many models of hammer mills have a rotor that may be turned 180°, so that the blunt edges can be used for fine grinding or the knife-edge can be used for cutting or granulating. The blunt edge offers the surface and the impact during milling, generating smaller granules. The knife-edge, because the sharper edge causes cutting of the granules, thereby generates larger granules. Individual blades—blunt, sharp, or reversible—are installed either fixed or swinging (Fig. 7A–C). Fixed blades plough through the material being ground, while swinging blades lie back and depend on the centrifugal force for movement. Fixed blades are preferred over swinging blades because they are easier to clean, and work better than swinging blades at low rotor speeds, when grinding fibrous material or if carefully

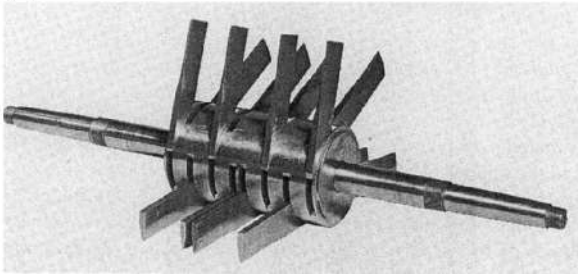
(A)



(B)



(C)



**Figure 7** Different types of hammer mill rotors (Fitzmill): (A) cast rotor, (B) bar rotor and (C) swing-blade rotor.

controlled grinding is needed. The material to be ground determines the configuration of the blades on the motor shaft, as well as the blade density. The shape of the blades (straight, stepped, sickle, or other) is largely a matter of designer preference; little empirical evidence exists to establish the superiority of one shape over another. The size of the grinding chamber generally determines the number of blades (e.g., a 6 in. grinding chamber will have 16 blades).

4. *Rotor speed:* The size of the product is markedly affected by the speed of the hammers. As a general rule, and with all other variables remaining constant, the faster the rotor's speed, the finer the grind. Usually, three speed settings are available: slow (1000 rpm), medium (2500 rpm), and fast (4000 rpm). Changes in rotor speed are accomplished by variable-speed drive, or by manually changing the hammer drive and motor pulley ratio. Rotor speeds of 2500–4000 rpm are typically used with blunt edges in fine grinding applications, whereas speeds of 1000–2500 rpm are typically used with knife-edges for coarse grinding. Particle size distributions are wider at low speed than at medium and high speeds (12). Below the critical rotor speed, the

material experiences attrition, rather than impact action, which causes more spheroidal granules and may result in overheating of the material.

5. *Screen size and type:* The screen is usually an integral part of the hammer mill and does not act as a sieve. The particle size of the product depends on the openings in the screen, the thickness of the screen, and the speed of the hammer. The particle size of the output granules will be much smaller than the size of the screen used, because particles exit at an angle, with high velocity.

Screens can be perforated, woven wire type, or with a slot configuration. The screen openings may range in size and open area based on screen configuration. Because of the large forces that the screens are subjected to, the perforated screens are preferred over the woven-type screens. However, if the raw material fuses from the heat generated, or if the material is difficult to mill, woven-type screens are preferred for their increased open area. The herringbone design and cross-slot are preferred for grinding amorphous and crystalline materials (Fig. 8).

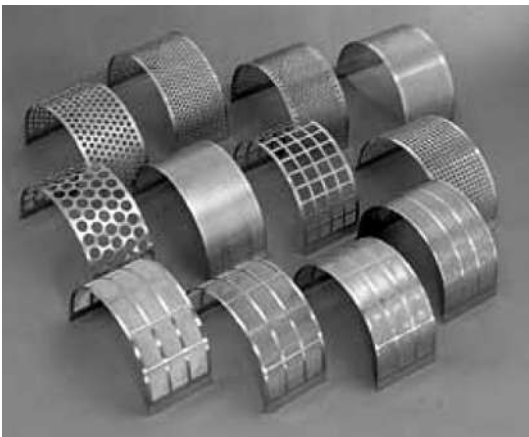
### 7.2.2. Conical Screening Mill

Similarly, for conical screening mills, the operating variables affecting particle size distribution are type of impeller, impeller speed, and screen size and type:

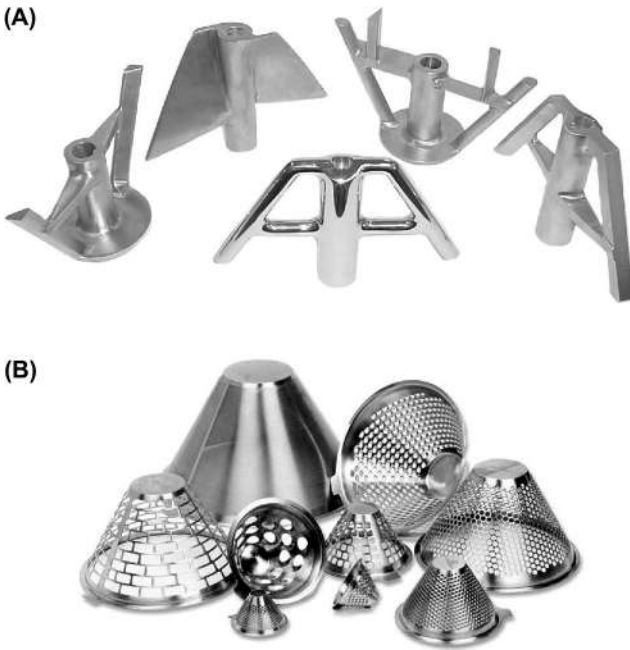
1. *Material feed rate:* In contrast to hammer mills, conical screening mills perform with greater efficiency when the comminution chamber is kept relatively full. Underfeeding results in low efficiency and reduced throughput.
2. *Impeller:* There are several types of impellers available (13); however, the four main types used frequently are as follows (Fig. 9A).

*Knife-edge:* Its principle mode of operation is shear, and hence, it is used for compression-sensitive, heat-sensitive materials.

*Round-edge:* Its principle mode of operation is compression, and it provides high throughput and low retention. It is mainly used for wet or dry deagglomeration–delumping.



**Figure 8** Different types of hammer mill screens.



**Figure 9** Conical screening mill (Comil): (A) impellers and (B) screens.

*Round-edge with teeth:* It is the same as the round-edge impeller except that it has teeth on one side, providing aggressive, high throughput. It reduces fines in milling compacted materials by prebreaking with teeth and reducing retention time. It is often used for tablet rework.

*Knife-edge low-intensity impeller:* It is used where a shear or cut is required; it gives a scissor-like action, for fibrous materials or capsule rework.

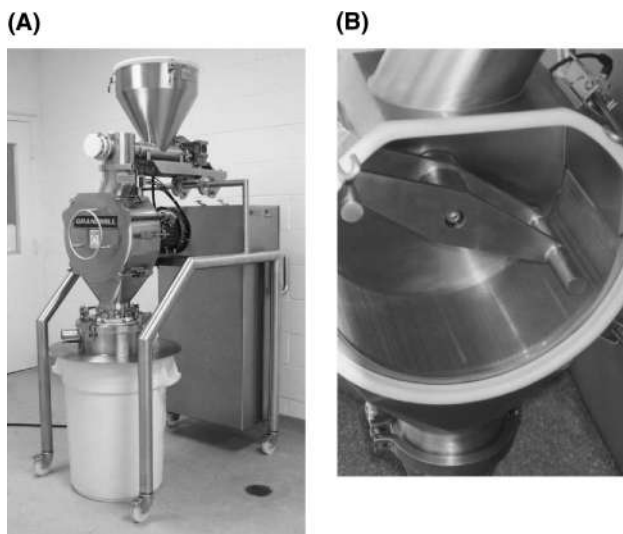
3. *Speed:* The speed of the impeller can affect the particle size of the product. Conical screening mills available have variable- or fixed-speed drives, however, the number of revolutions per minute vary depending on the size of the impeller. It is suggested that one keep the tip speed of the impeller the same on scale-up to achieve the same particle size distribution.
4. *Screen size and type:* Screens are available in various sizes (Fig. 9B), based on thickness, open area, and hole configuration such as round, square, slotted, and grater-type openings. Only perforated screens are available.

Various researchers have performed extensive studies of the effects of the foregoing variables on granulation and milling processes (20–22). Motzi et al. (21), based on their observations of significant interaction effects, concluded that effects of mill speed, screen size, and impeller shape on particle size distribution cannot be evaluated individually, but must be evaluated at a level that is a combination of all three.

### 7.2.3. Hybrid Designs

Hybrid designs, such as the Granumill (Fig. 10A and B), are now available which utilize a one-piece cantilever rotor with heavy blades mounted parallel to the center





**Figure 10** Hybrid design: (A) Granumill and (B) detail of Granumill rotor and screen.

shaft. Incorporating a variable-speed drive, these mills operate as screening mills when run at low speed, and as impact mills when run at high speed.

### 7.3. Other Variables

There are other variables that can affect the sizing process, such as feed material properties, granulation process, and drying process. The properties of materials have been discussed in Section 3. The type of granulation [i.e., dry (roller compaction), planetary, high-shear, or fluid-bed] can determine the strength of the granules and, hence, the sizing process. Furthermore, the drying process, whether tray or fluid-bed, can also be important. Tray-dried granules are usually case hardened and difficult to mill, whereas the fluid-bed process yields more porous and friable granules. Similarly, granules produced by high-shear granulators are harder and are therefore more difficult to mill than those manufactured using low-shear or fluid-bed processes.

## 8. SCALE-UP

### 8.1. Hammer Mill

Table 2 shows the various sizes of Fitzmills available (12). In addition to having the same screen size and type used on the lower scale, keeping the rotor tip speed constant is one of the most important considerations in scale-up of a milling process. Vertical and horizontal rotor configurations may affect throughput and also particle size distribution.

### 8.2. Conical Screening Mill

Table 3 shows the scale-up parameters for various Comils (13). In addition to having the same impeller type, screen size, and screen type used on the lower scale, the tip

**Table 2** Scale-up Parameters for Fitzmill

Model	Chamber				Rotor configuration	Rotor			
	Capacity <sup>a</sup> factor	Nominal width	Screen area (in. <sup>2</sup> )	Diameter of chamber		No. of blades	Tip speed factor <sup>b</sup>	Maximum rpm	Maximum horsepower
Homoloid	0.4×	2.5	43.0	6.625	Horizontal	12	1.73	7200	10.0
M5A	0.7×	4.5	76.0	8.0	Horizontal	16	2.09	4600	3.0
D6A	1.0×	6.0	109.0	10.5	Horizontal	16	2.75	4600	5.0
DAS06	1.0×	6.0	109.0	10.5	Horizontal	16	2.75	4600	15.0

<sup>a</sup>Throughput relative to Model D6 at the same tip speed.

<sup>b</sup>Tip speed = factor × operating speed.

Source: From Ref. 12.

**Table 3** Scale-up Parameters for Comil

Model	Capacity factor	Impeller diameter (in.)	Screen size (in.) <sup>a</sup>			Impeller speed scale-up comparison (rpm)							Motor horsepower	Infeed opening (in.)
			A	B	C	1200	2400	3600	4800	6000	7200	—		
197	1×	4.375	5	1.5	3	1200	2400	3600	4800	6000	7200	—	1 or 2	3 Round
194	5×	7.625	8	2.5	5	700	1400	2100	2800	3500	4200	5600	5	6 Round
196	10×	11.125	12	4	7	450	900	1350	1800	2250	2700	3600	10 or 15	8 Round
198	20×	23.250	24	16	7	225	450	675	900	—	—	—	20	11 × 22 Rectangular
199	40×	29.469	30	16	12	180	360	540	—	—	—	—	30	12 × 24 Rectangular
Tip speed (ft/min)						1400	2800	4200	5600	7000	8400	11,200		

<sup>a</sup>A, screen upper diameter; B, screen lower diameter; C, screen height.

Source: From Ref. 13.

speed of the impeller is one of the key variables in scale-up; thus, it should be kept constant.

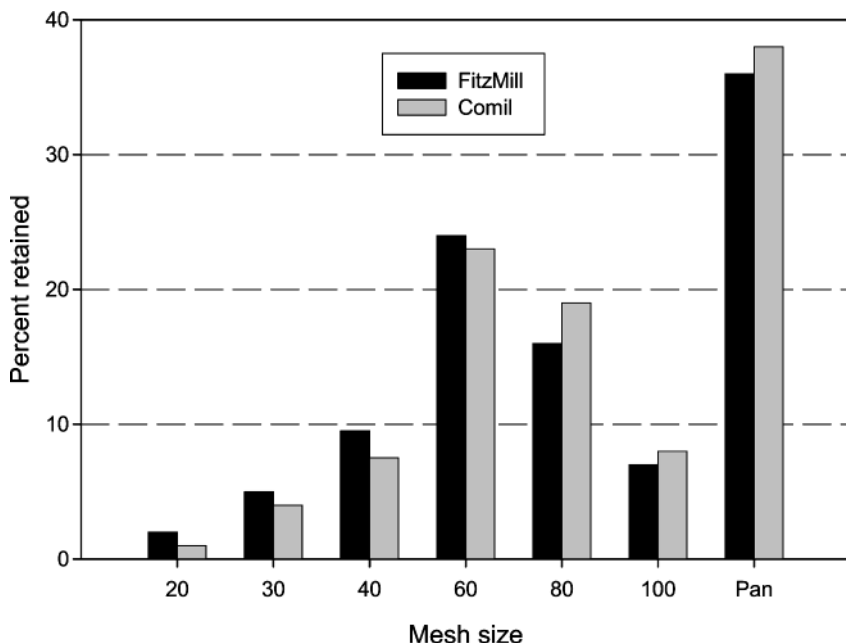
## 9. CASE STUDIES

### 9.1. Comparison of Fitzmill vs. Comil

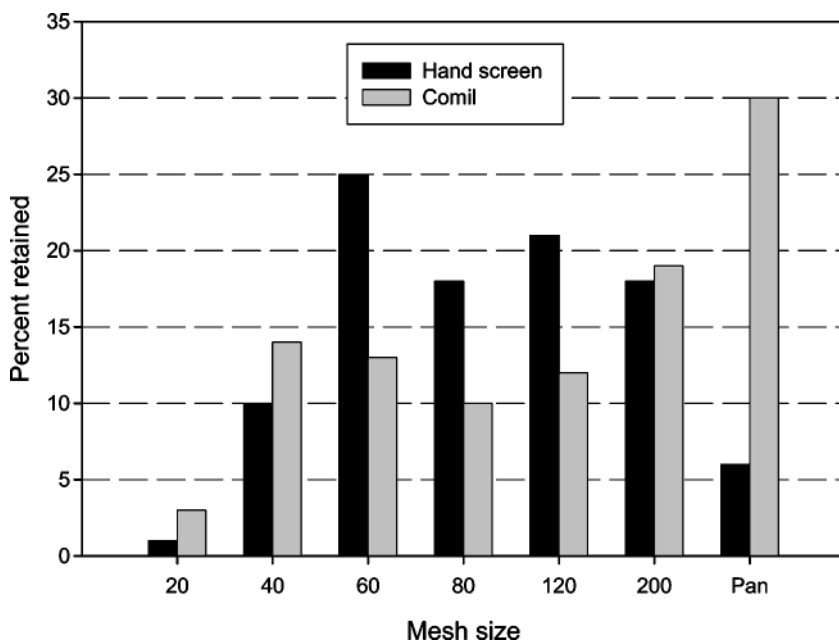
It is often difficult to predict the results from similar pieces of equipment having the same operating principle at two different scales, let alone using two pieces of equipment having different operating principles. Many times in the development of a pharmaceutical dosage form the equipment used during formulation development and that used in production are quite different. Apelian et al. (22) studied the effect of particle size distribution on chlorpheniramine maleate granules using a Fitzmill and Comil. For the Fitzmill, various screens sizes (1, 2, 3, and so on) at medium speed were evaluated, and for the Comil, impellers (1601 and 1607) at two speeds (1680 and 3420 rpm) using various screen sizes (039, 045, 055, and 055G) were studied. They reported that milling the granulation using a Fitzmill with a screen size of 2, at medium speed, gave a particle size distribution similar to the granulation milled using a Comil (1601 impeller, 055 screen at 1680 rpm) (Fig. 11). The results of this study suggest that in making a major change in the milling process, one needs to optimize the critical processing variables in order to achieve a similar particle size distribution.

### 9.2. Comparison of Hand Screen vs. Comil

The effect of changing the dry milling from a hand screen operation to a conical screening mill is shown in Figure 12. Naproxen granulations (0.5 and 4 kg) were



**Figure 11** Particle size distribution of chlorpheniramine maleate granulations milled using FitzMill and Comil.



**Figure 12** Particle size distribution of naproxen granulations milled using hand screen and Comil.

manufactured in a fluid-bed granulator using PVP K-90 as a binder (23). The particle size distribution of granules (0.5 kg), passed manually through an 18-mesh screen, was much coarser than that of the granules (4 kg) that were milled using a Comil (Model 197S). A flat-faced impeller (1607) at an impeller speed of 2500 rpm with a spacer setting of 0.25 in. and screen number 2A055 (14-mesh) were used for the milling operation. Even though the granulations were prepared by the same procedure, the milling conditions drastically affected the particle size distribution. As a general rule, during a switch over from a low-energy milling operation to a high-energy milling operation the screen size should be coarser in the high-energy mill. The particle velocity is higher and therefore the size of the granule exiting out of the screen is much smaller than the screen opening. As seen from Figure 12, when the screen size was increased to 14-mesh for the conical-screening mill, the amount of fines generated was higher. Hence, during scale-up, optimization of milling conditions may be necessary to achieve the same particle size distribution.

## 10. LIST OF EQUIPMENT SUPPLIERS

1. The Fitzpatrick Company, 832 Industrial Drive, Elmhurst, IL 60126, USA;  
[www.fitzmill.com](http://www.fitzmill.com)
2. Fluid Air, Inc., 2550 White Oak Circle, Aurora, IL 60504, USA;  
[www.fluidairinc.com](http://www.fluidairinc.com)
3. Frewitt Ltd., P.O. Box 61, CH-1706 Fribourg, Switzerland;  
[www.frewitt.com](http://www.frewitt.com)
4. Glatt Air Techniques Inc., 20 Spear Road, Ramsey, NJ 07446, USA;  
[www.glattair.com](http://www.glattair.com)

5. Niro, Inc., 9165 Rumsey Road, Columbia, MD 21045, USA;  
[www.niro.com](http://www.niro.com)
6. Quadro Inc., 55 Bleeker Street, Millburn, NJ 07041, USA;  
[www.quadro.com](http://www.quadro.com)
7. Vector Corporation, 675 44th Street, Marion, IO 52302, USA;  
[www.vectorcorporation.com](http://www.vectorcorporation.com)

## ACKNOWLEDGMENTS

The authors would like to thank Dr. Murali K. Vuppala of Praecis Pharmaceuticals Inc. for coauthorship of the first edition of this chapter, Mr. Scott Wennestrum from The Fitzpatrick Company, Mr. John Bender from Fluid Air, Inc., Mr. David Adams and Mr. Patrick Arthur from Quadro, Inc., and Mr. Jeff Montross from Glatt Air Techniques, Inc. for providing the photographs shown in this chapter.

## REFERENCES

1. Prescott JK, Hossfeld RJ. Maintaining product uniformity and uninterrupted flow to direct-compression tableting presses. *Pharm Tech* 1994; 18:98–114.
2. Lantz RJ Jr. Size reduction. In: Lieberman HA, Lachman L, Schwartz JB, eds. *Pharmaceutical Dosage Forms: Tablets*. Vol. 2. New York: Marcel Dekker, Inc., 1990:107–157.
3. Fonner DE, Anderson NR, Banker GS. Granulation and tablet characteristics. Lieberman HA, Lachman L, eds. *Pharmaceutical Dosage Forms: Tablets*. Vol. 2. New York: Marcel Dekker, Inc., 1981:201.
4. Parrot EL. Milling. Lachman L, Lieberman HA, Kanig JL, eds. *The Theory and Practice of Industrial Pharmacy*. Philadelphia: Lea & Febiger, 1986:21–46.
5. O’Conner RE, Rippie ED, Schwartz JB. Powders. Gennaro AR, ed. *Remington’s Pharmaceutical Sciences*. Easton, PA: Mack Publishing Company, 1990:1615–1617.
6. Carstensen JT, Puisieux F, Mehta A, Zoglio MA. Milling kinetics of granules. *Int J Pharm* 1978; 1:65–70.
7. Steiner G, Patel M, Carstensen JT. Effect of milling on granulation particle—size distribution. *J Pharm Sci* 1974; 63:1395–1398.
8. Motzi JJ, Anderson NR. The quantitative evaluation of a granulation milling process. III. Prediction of output particle size. *Drug Dev Ind Pharm* 1984; 10:915–928.
9. Snow RH, Kaye BH, Capes CE, Sresty GC. Size reduction and size enlargement. Perry RH, Green D, eds. *Perry’s Chemical Engineers’ Handbook*. New York: McGraw-Hill Inc., 1984:8-9–8-20.
10. Prior MH, Prem H, Rhodes MJ. Size reduction. Rhodes MJ, ed. *Principles of Powder Technology*. New York: John Wiley & Sons, 1990:237–240.
11. Kukla RJ. Strategies for processing heat-sensitive materials. *Powder Bulk Eng* 1988; 2:35–43.
12. FitzMill Technical Bulletin. The Fitzpatrick Company, Elmhurst, IL.
13. Quadro Inc., CoMil Product Literature, Millburn, NJ.
14. Poska RP, Hill TR, van Schaik JW. The use of statistical indices to gauge the mixing efficiency of a conical screening mill. *Pharm Res* 1993; 10:1248–1251.
15. Fourman GL, Cunningham DL, Gerteisen RL, Glasscock JF, Poska RP. Improved color uniformity in tablets made by the direct compression method: a case study. *Pharm Tech* 1990; 14:34–44.
16. Schwartz JB. Theory of granulation. Kadam KL, ed. *Granulation Technology for Bio-products*. Boca Raton, FL: CRC Press, 1990:17.
17. Johnson C. Comminution variables and options. *Powder Bulk Eng* 1989; 3:40–44.

18. Owens JM. How to correct common hammermill problems. *Powder Bulk Eng* 1991; 5:38–43.
19. Hajratwala BR. Particle size reduction by a hammer mill I: effect of output screen size, feed particle size, mill speed. *J Pharm Sci* 1982; 71:188–190.
20. Byers JE, Peck GE. The effect of mill variables on a granulation milling process. *Drug Dev Ind Pharm* 1990; 16:1761–1779.
21. Motzi JJ, Anderson NR. The quantitative evaluation of a granulation milling process. II. Effect of output, screen size, mill speed and impeller shape. *Drug Dev Ind Pharm* 1984; 10:713–728.
22. Apelian V, Yelvigi M, Zhang GH, et al. Comparison of quadromill and fitzmill used in milling process of granulation. *Pharm Res* 1994; 11:S-142.
23. UMAB/FDA Collaborative Agreement RFP # 223–91–3401.

# 18

## Granulation Characterization

**Raj Birudaraj**

*Roche Palo Alto, Palo Alto, California, U.S.A.*

**Sanjay Goskonda**

*Durect Corp., Cupertino, California, U.S.A.*

**Poonam G. Pande**

*Synthon Pharmaceuticals Inc., Research Triangle Park, North Carolina, U.S.A.*

### 1. INTRODUCTION

Granulation is a process selected by formulation scientists to prevent segregation of formulation components in a powder mix, improve blend flow, bulk volume of granulation, content uniformity, compressibility, and other properties. Granulation minimizes the technical risks associated from batch to batch variability in raw materials that could impact the manufacturing process and performance. Various granulation techniques such as high- and low-shear granulation, roller compaction, spray drying, fluid-bed granulation, extrusion spononization, and melt granulation are used in solid dosage form development. The choice of granulation technique depends on various factors such as chemical and physical stability of the final dosage form, intended biopharmaceutical performance, and is occasionally limited due to available equipment. Dosage form performance is assessed through a characterization program in which drug dissolution, bioavailability, chemical stability, or manufacturing ruggedness is taken into account. The scientist can rely on many different tools for granulation characterization. These tools can probe the physical and chemical attributes of the material. In this chapter many characterization techniques that are applied to granulation will be reviewed. Most of the techniques used for granulation characterization are conducted during the research and development stage of product development. A significant portion of this chapter was adapted from the previous edition of *Handbook of Pharmaceutical Granulation Technology* (1).

### 2. PHYSICAL AND CHEMICAL CHARACTERIZATION OF GRANULES

Physical property characterization of pharmaceutical granulations has been extensively reported in literature. Chemical properties are equally important due to their impact on specifications of a dosage form such as content uniformity, chemical

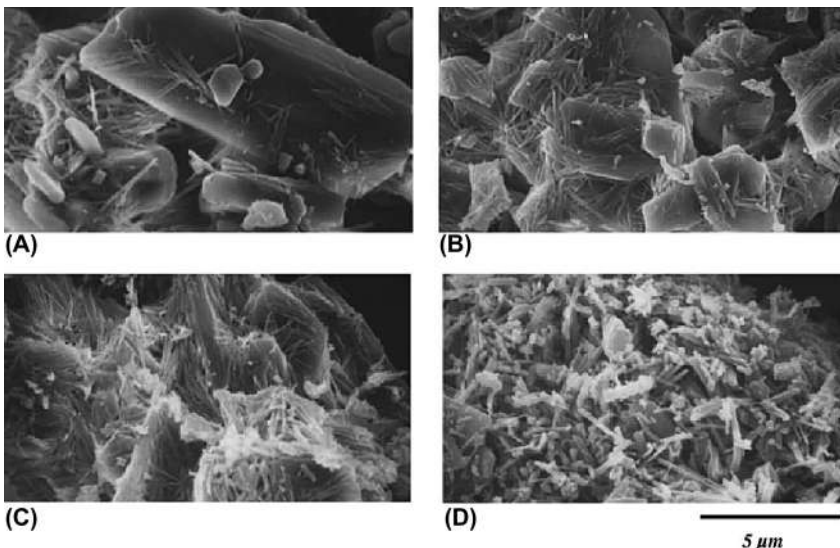
purity, and in vitro performance. The interaction between physical characteristics of a formulation and chemical-based performance should not be understated. In vivo performance such as bioequivalence is the ultimate performance test because it is this “characterization” that determines whether a pivotal bioequivalency batch passes or fails. The effect of granule size on the dissolution performance, for example, could ultimately affect the outcome of such a bioequivalence study. The complexity of this kind of relation underscores how something seemingly simple, such as particle size and its dependence on granulation process parameters, can influence dissolution and ultimately in vivo performance.

Physical characterization can be performed at molecular, particulate, or bulk (macroscopic) levels. From the terminology cited by Brittain et al. (2), molecular properties are associated with individual molecules, particulate properties are considered as properties that pertain to individual solid particles, and bulk properties are those that are associated with an assembly of particulate species. Most reports in pharmaceutical literature cover characterization of bulk properties.

## 2.1. Particle Morphology

Particle morphology can be assessed using optical microscopy. Samples of granulation can be evaluated directly under a microscope or sorted using a device proposed by Ridgeway and Rupp (3) in which the granulation is fed onto a triangular metal deck and vibrated. Particles of different shapes segregate on this deck and are collected for analysis by microscopy.

Another technique to study particle morphology is scanning electron microscopy. Yoshinari et al. (4) studied morphological changes in granule shape with the addition of different amounts of granulating fluid (Fig. 1).



**Figure 1** Scanning electron micrographs of mannitol granules obtained after treating  $\delta$ -crystal with various ratio of water: (A) 5% w/w, (B) 10% w/w, (C) 15% w/w, and (D) 25% w/w. (From Ref. 4.)

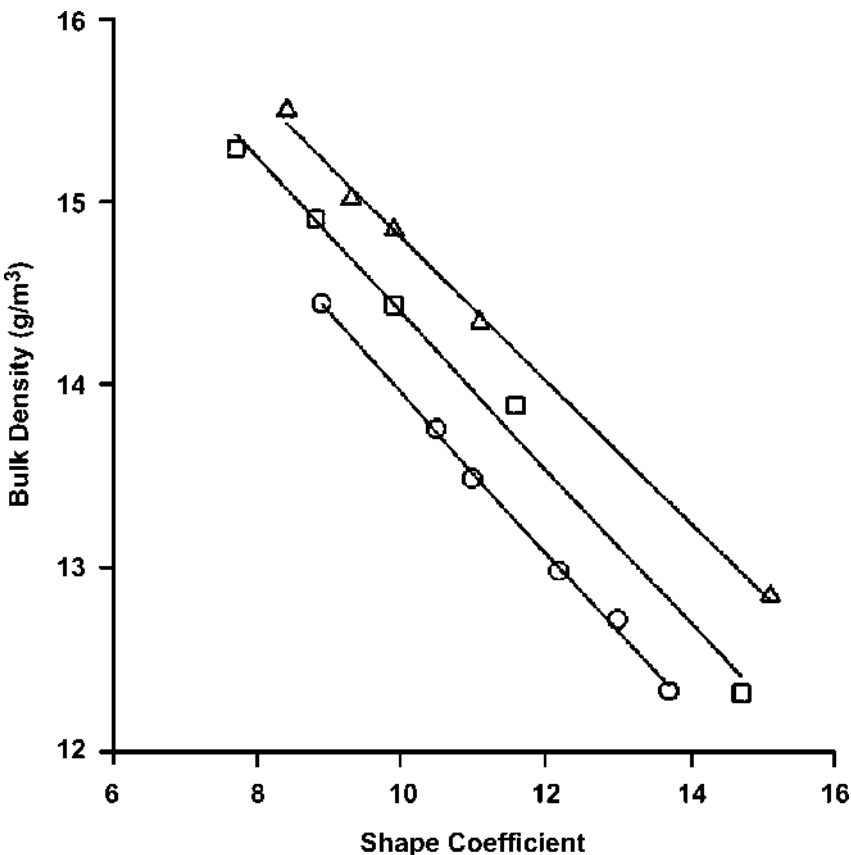


Particle shape can be quantified by different methods. One popular method is through the use of Heywood coefficients (5). The Heywood shape coefficient is defined as the ratio of the surface shape coefficient ( $\pi$  for a sphere) to the volume shape coefficient ( $\pi/6$  for a sphere); hence, the shape coefficient for a sphere would be 6.0. Applying this to a cube and using its projected area in its most stable position, the shape coefficient is 6.8. Cutting the cube in half in one dimension increases the shape factor to 9.0, whereas it increases to 26.6 if that cube was sliced one-tenth in one dimension. Further details of these types of calculations are provided by Rupp (5).

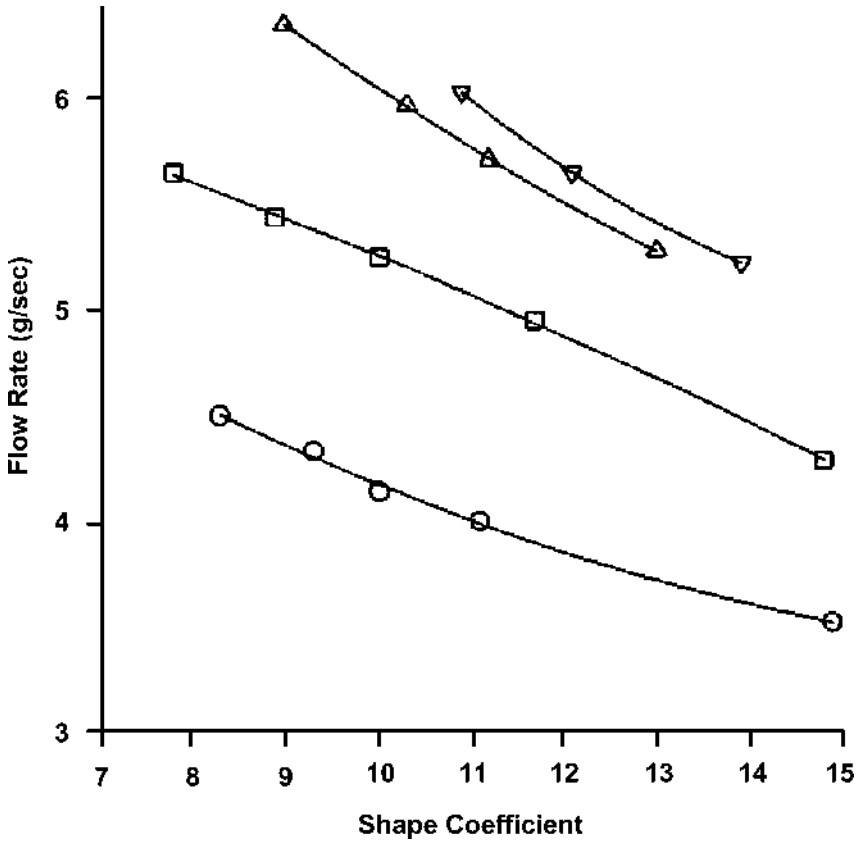
The effect of particle shape on bulk powder properties has been illustrated by Rupp (5). The effect of particle size and shape on the bulk density and flow rate is illustrated in Figures 2 and 3. As illustrated in these examples, packing of powder in the bulk becomes more efficient as the shape factor or loss in sphericity increases. The flow rate becomes worse with loss in sphericity.

## 2.2. Particle Size Distribution

Particle size distribution can be measured by sieve analysis, laser light scattering, or optical microscopy (2). Light-scattering techniques are generally not applied to granulations due to the large size distribution of granules. Dry-sieve analysis and



**Figure 2** Bulk density as a function of shape factor: triangles, 302  $\mu\text{m}$ ; squares, 461  $\mu\text{m}$ ; and circles, 805  $\mu\text{m}$ . (From Ref. 3.)

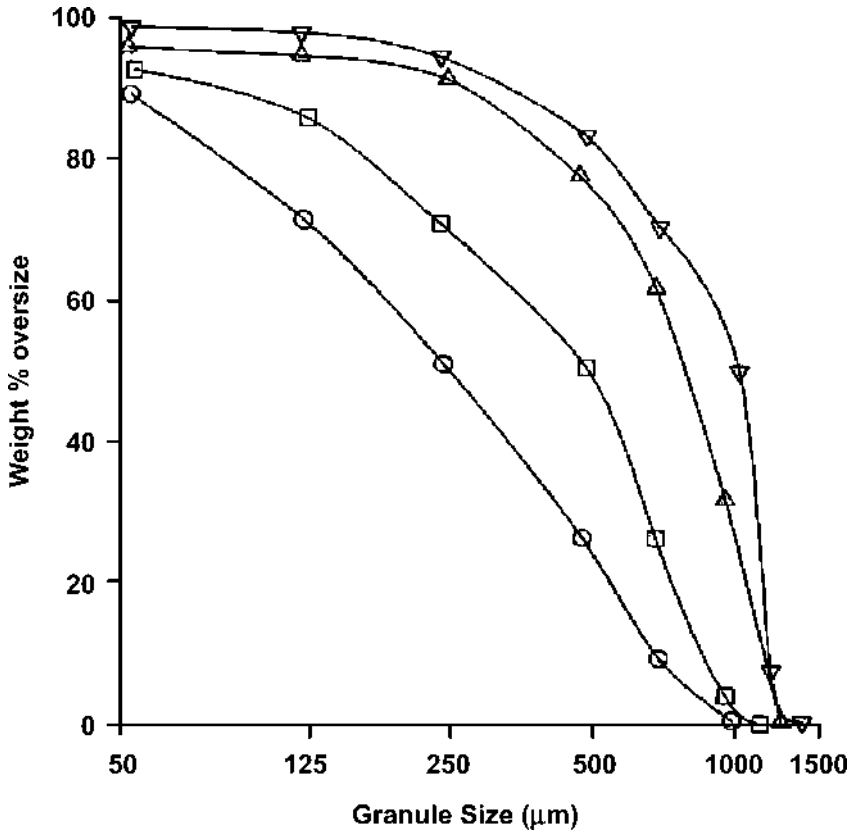


**Figure 3** Effect of particle shape on flow rate for an orifice diameter of 6.34 mm: triangles, 302  $\mu\text{m}$ ; squares, 461  $\mu\text{m}$ ; and circles, 805  $\mu\text{m}$ . (From Ref. 3.)

microscopy are generally the most popular methods for determining size distribution of granules. Microscopy provides a more exact measurement of size, although it is the most labor-intensive method. Computer-aided image analysis techniques have been employed to simplify the method, but some problems, such as three-dimensional surface effects could be misinterpreted by the computer, resulting in errors in the calculated distribution.

Dry-sieve analysis is the easiest and the most convenient method for measuring granule size. The granulation is placed on top of a stack of five to six sieves which have successively smaller-sized openings from top to bottom. The stack is vibrated, and the particles collect on top of the sieves. The data are usually represented in terms of percentage retained on the sieve, or percentage that is undersize or oversize vs. screen-opening size (Fig. 4) (6).

Two factors—particle size distribution and shape—can bias a distribution obtained by sieve analysis. According to Shergold (7), variations in particle size distribution can be obtained due to the loading of the stack, which in turn, is affected by the particle size distribution and shape of the powder being analyzed. In a more extensive evaluation, Fonner and co-workers (8) studied the effect of loading, shaker speed, and time on the data obtained for particle size distribution of model granulations. Particle breakage occurred at increasing shaker speeds and times. According to



**Figure 4** Sieve analysis of lactose granules formed by massing and force screening showing effect of binder fluid level: circles, 15.3% v/v; squares, 18.4% v/v; upward triangles, 23% v/v; and downward triangles, 30.6% v/v. (From Ref. 6.)

the authors, particle attrition causes the loading of material to influence the time to reach equilibrium. In this article, time to reach equilibrium is defined as the time at which the material passes through the sieve. The authors finally concluded that a nonbiased analysis of particle size distribution should include an analysis of equilibrium times for each sieve.

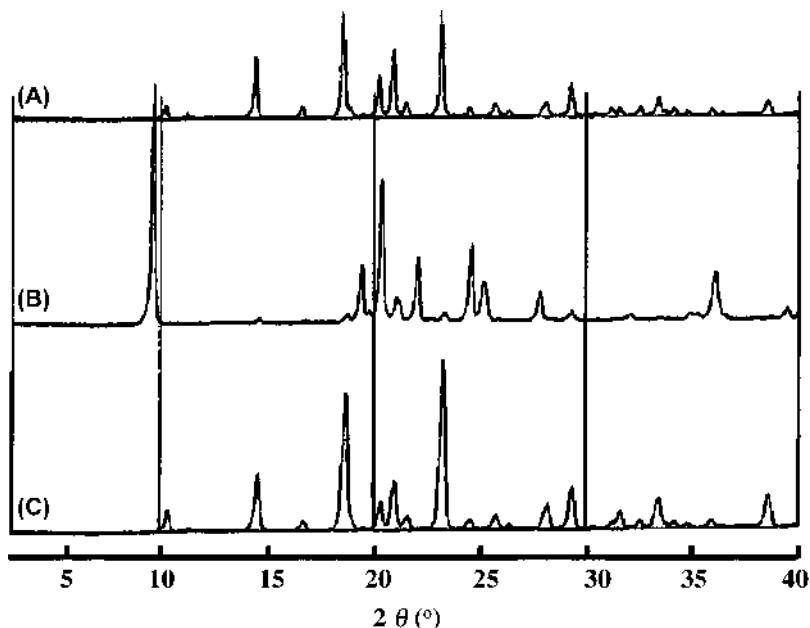
An example for use of sieve analysis was offered by Stevens (9), who addressed the effect of granule size distribution on the weight variation of tablets by constructing “isovariational curves.” The intent of this evaluation was to define a geometric mean diameter and distribution that would result in an acceptable tablet weight variation. The geometric standard deviation was inverted and named the “*R*-value.” Granulations with various mean diameters and distributions were prepared by sieving, recombining, and running on a rotary tablet press. The coefficient of variation (CV) for tablet weight was recorded for each run. *R*-values and CV for each geometric mean diameter were obtained from CV–*R* plots and then placed on a contour plot containing geometric mean diameter (abscissa), *R*-value (ordinate), and CV (isovariational contour lines). Although the author claimed this must be done on a case-by-case (and press-by-press) basis, these curves can be used to select the optimal mean granule size and distribution to minimize tablet weight variation.

### 2.3. Powder X-Ray Diffraction

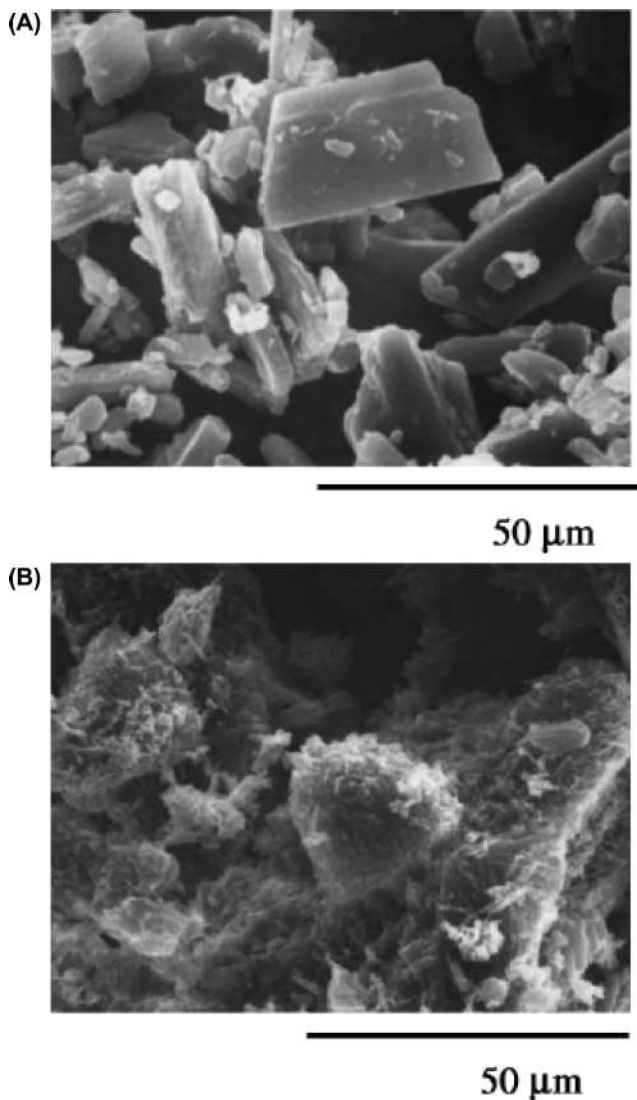
A detailed description of powder x-ray diffraction is provided by Brittain et al. (2) and the references cited therein. This technique is mostly used to determine the crystalline form of a solid. Understanding the effect of granulation on the form of bulk drug has gained increasing attention in the past few years (10). X-ray techniques provide the formulator with a first line of analysis in the determination of polymorph changes as a result of processing. In a joint American Association of Pharmaceutical Science–Federal Drug Administration (AAPS–FDA) report, an experimental rationale “where both the applicant (industry) and the FDA are in better position to assess the possible effects of any variations in the solid-state properties of the drug substance” was provided. Both x-ray and solid-state nuclear magnetic resonance were recommended techniques for assessing the crystalline form of drug substance in a drug product (8).

Yoshinari et al. (4) used x-ray techniques to report polymorphic transition of mannitol during wet granulation. These authors stated that after vacuum drying the wet granulated  $\delta$ -crystal of mannitol, a polymorphic change occurred to  $\beta$ -crystal polymorph (Fig. 5). Concomitant morphological changes were noted in the scanning electron micrographs (Fig. 6) which showed that  $\delta$ -granules consisted of small primary particles of the  $\beta$ -form of mannitol.

Modulated temperature x-ray powder diffraction (XRPD) is being used increasingly in the pharmaceutical industry both at preformulation and at formulation stages. Airaksinen et al. (11) studied polymorphic transitions during drying using two methods: a multichamber microscale fluid-bed dryer or a variable temperature powder x-ray diffractometer. Relative amounts of different polymorphic



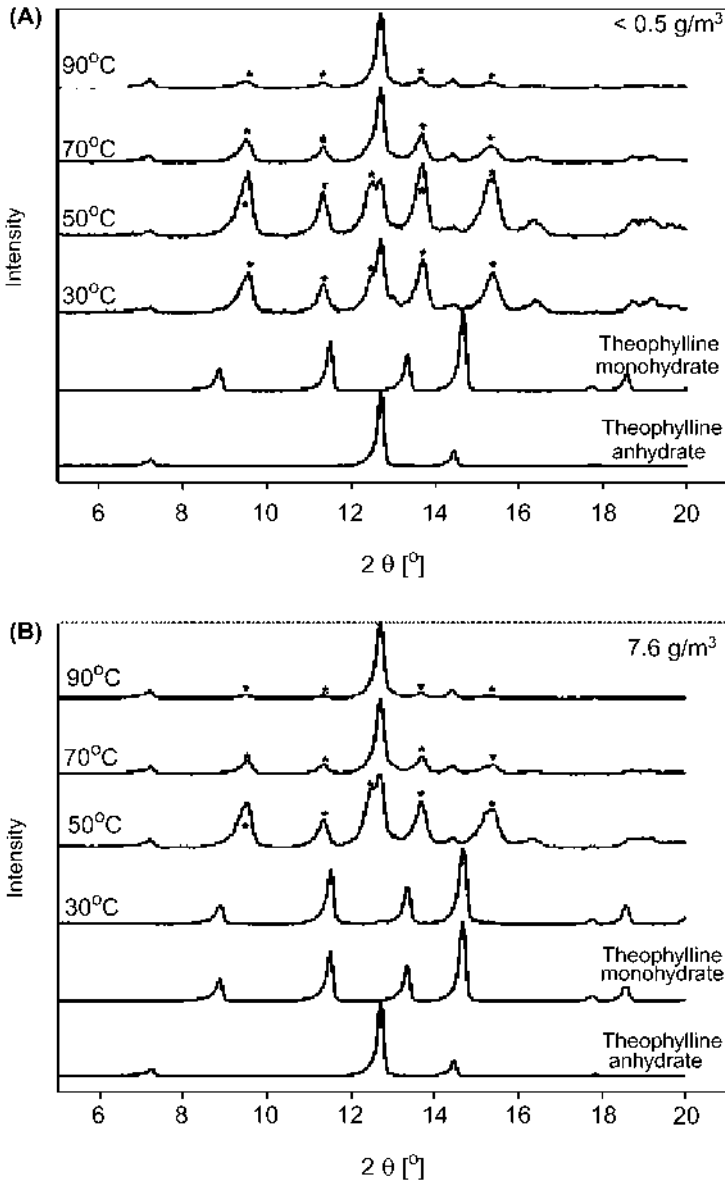
**Figure 5** Powder X-ray patterns of mannitol: (A)  $\delta$ -crystal of mannitol after granulation and vacuum drying, (B)  $\delta$ -crystal of mannitol before granulation, and (C)  $\beta$ -crystal. (From Ref. 4.)



**Figure 6** Scanning electron micrographs of  $\delta$ -crystal of mannitol: (A) before and (B) after granulation. (From Ref. 4.)

forms of theophylline remaining in the dried granules were determined by XRPD. The authors concluded that metastable anhydrous theophylline predominated when the granules were dried at 40–50°C. Temperature >50°C produced mostly anhydrous theophylline, more than 20% of the metastable form remained even at 90°C (Fig. 7).

Morris and co-workers (12) reported polymorphic changes when hydroxymethylglutarate coenzyme A reductase inhibitor was wet-granulated with water. The starting material was in the anhydrous form, which then converted to an amorphous form during the wet-granulation process. The loss in crystallinity was experimentally determined using powder x-ray diffraction. Exposure of this



**Figure 7** (A) XRPD patterns of theophylline granules dried using a multichamber microscale fluid-bed dryer (MMFD) at temperatures ranging from 30°C to 90°C using dry inlet air (under  $0.5 \text{ g/m}^3$ ). (B) XRPD patterns of theophylline granules dried using MMFD at temperatures ranging from 30°C to 90°C using ambient inlet air ( $7.6 \text{ g/m}^3$ ). Note the characteristic peaks of theophylline anhydrate metastable form (\*). XRPD patterns of theophylline monohydrate and theophylline anhydrate at room temperature are shown below as controls. (From Ref. 11.)

granulation to an environment of  $>33\%$  relative humidity, caused a form conversion to its crystalline hydrate. This series of experiments demonstrated the usefulness of a sophisticated technique, such as XRPD, in the assessment of the physical stability of bulk drug during granulation.

## 2.4. Thermal Analysis

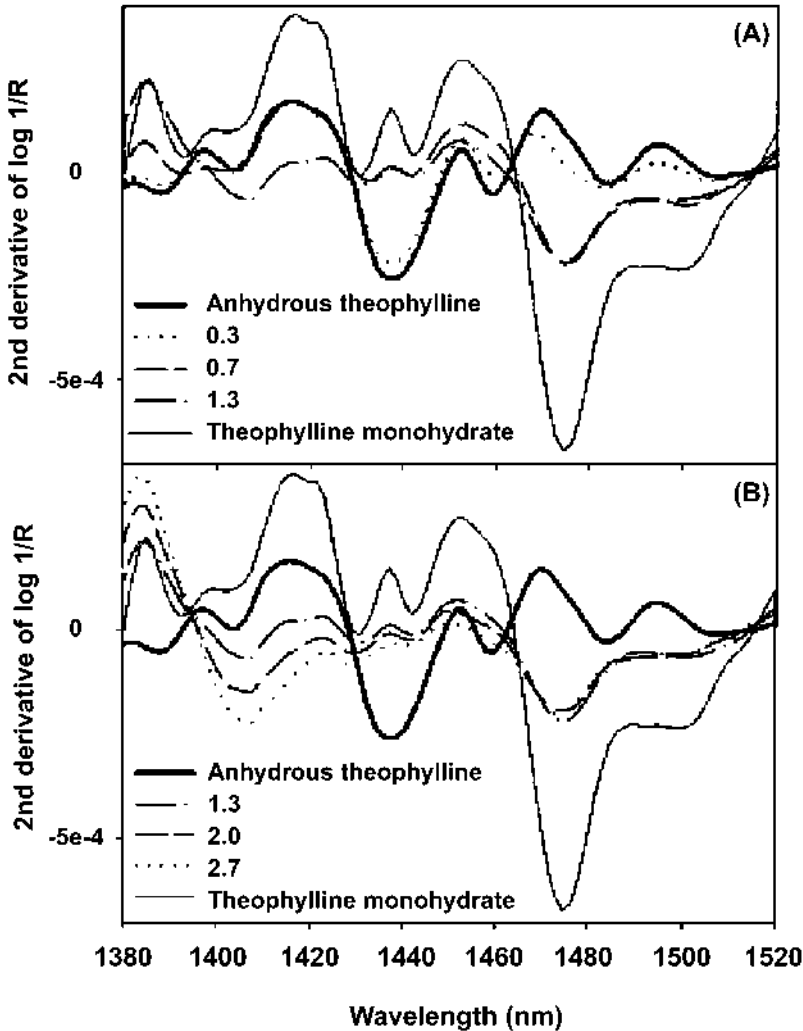
Standard thermal methods of analysis include differential scanning calorimetry (DSC), differential thermal analysis, and thermogravimetric analysis. A common application of thermal analysis in characterization of granulations is based on thermogravimetry and is known as loss on drying (LOD). In a LOD analysis, a sample of the granulation is heated at a temperature near the boiling point of water or solvent. The weight loss, recorded directly on an analytical balance, is due to the evaporation of water or solvent and is considered the residual moisture content of a granulation (13). This technique is extensively used to establish both granulation and drying parameters for wet-granulation unit operations (14–16).

DSC was used in the evaluation of a phase change of chlorpromazine hydrochloride after wet granulation (17). The starting drug substance (form II) converted to a hemihydrate (form I-H) after it was wet-granulated with water–ethanol binder fluid. Form I-H converted to a partially dehydrated form (I-H') after drying. An investigation of this form led the authors to another anhydrous polymorph (form I). Extensive characterization by DSC showed the transition from hemihydrate (form I-H) to anhydrous form (form I) at 40–50°C, followed by a conversion from form I to form II at  $\approx 135^\circ\text{C}$ , and finally, melting at 185–189°C (17). By solution calorimetry, form I was found to be the most stable based on their heat of solution ( $\Delta H$ ) values. Although the dissolution profiles of both anhydrous forms were equivalent, the two forms had different tableting characteristics. The more stable form I did not exhibit the severe capping problems originally observed for form II. Granulations made with ibuprofen and  $\beta$ -cyclodextrin were evaluated using DSC. Lower  $\Delta H$  values for oven-dried granulations indicated better complexation and faster dissolution than air-dried granulations (18).

DSC is a valuable tool in characterizing granulations made by hot melt extrusion for determining glass transition temperatures and crystalline or amorphous nature of the formulation. Perissutti et al. (19) used this technique to characterize carbamazepine and polyethylene glycol 4000 granules obtained after hot melt granulation.

## 2.5. Near-Infrared Spectroscopy

Near-infrared (NIR) spectroscopy is a fast, nondestructive method and requires no sample preparation (20). In the NIR region, absorption bands are mainly caused by overtones and combination vibrations of CH, NH, and OH groups. Intact and rapid NIR spectroscopy offers advantageous possibilities of in-line measurements during granulation processes to measure moisture content and detect any physicochemical changes (21,22). Rasanen et al. (20) studied the polymorphic conversion of theophylline during wet granulation using NIR. The authors found that at a low level of granulation liquid (0.3 mol of water per mole of anhydrous theophylline), water absorption maxima in the NIR region occurred first at around 1475 and 1970 nm. These absorption maxima were identical to those of theophylline monohydrate. At higher levels of granulation liquid ( $1.3 \pm 2.7$  mol of water per mole of anhydrous theophylline), increasing absorption maxima occurred at 1410 and 1905 nm due to OH vibrations of free water molecules (Fig. 8).



**Figure 8** Second derivative of absorbance of anhydrous theophylline, theophylline monohydrate, and theophylline granules at 1380–1520 nm: (A) anhydrous theophylline transformation into theophylline monohydrate at around 1475 nm; and (B) effect of free water molecules at around 1410 nm (number indicating mole(s) of water per mole of anhydrous theophylline). (From Ref. 20.)

## 2.6. Electrostatic Charge

Static charge is generated when two bodies come into intimate contact and then are separated. The surface of one of the contacting bodies attracts electrons from the other surface, thereby resulting in a negative charge. Forces of attraction and repulsion can cause significant problems in powder handling. Gold and Palermo (23) described a technique that measures the static charge of a powder as it passes out of a hopper. The surface separation between particles occurs frequently in this dynamic environment. In the system proposed by these authors, powder was allowed to flow out of a hopper onto a glass receptacle. Directly beneath this receptacle was a copper disk that was attached to another copper disk beneath an ionostat. The



ionostat recorded voltage transmitted by the first disk. It was found that acetaminophen, when granulated with either starch paste or syrup, exhibited a much lower static charge than ungranulated powder. This reduction in static charge correlated with improved flow out of the hopper.

## 2.7. Surface Area

Granulation properties are mainly dependent on the size and surface area of particles and granules (24,25) The surface area of a granule or particle can also affect the dissolution rate of a solid. Gas adsorption is the most common method to determine surface area, although liquid penetration methods have also been proposed (26). In one of the methods developed by Brunauer, Emmet, and Teller, called the BET method (27), an inert gas is adsorbed onto the surface of a solid at low temperature and then desorbed at room temperature (1). Either nitrogen or krypton is used as the adsorbate, and helium is usually used as a carrier gas for the adsorbate. Various concentrations of adsorbate in carrier gas are used in this analysis to determine the volume of gas that is adsorbed in a monolayer on to the solid. Eq. 2.1 is used to determine this value

$$\frac{P}{V(P_0 - P)} = \frac{1}{V_m C} + \frac{(C - 1)P}{V_m C P_0} \quad (2.1)$$

where  $V$  = volume of gas adsorbed at pressure  $P$ ,  $P$  = partial pressure of adsorbate,  $C$  = a constant relating the heats of adsorption and condensation of the adsorbate,  $P_0$  = saturation pressure of adsorbate at experimental temperature, and  $V_m$  = volume of gas adsorbed in monolayer of solid.

A plot of  $P/V(P_0 - P)$  vs.  $P/P_0$  yields a straight line.  $V_m$  is calculated from both the slope and the intercept of this line (27). The specific surface area (SSA), in units of square meters per gram is calculated using Eq. 2.2

$$\text{SSA} = \frac{(V_m N_0 A_{cs})}{M} \quad (2.2)$$

where  $N_0$  = Avogadro's number,  $A_{cs}$  = cross-sectional area of adsorbate, and  $M$  = mass of solid sample.

Another method that has been proposed for measuring the surface area of powders is known as air permeability (28). A column packed with powder is subjected to a stream of air. The system is sealed off and the pressure drop is measured across the bed. To take into account the "slip" of gas along walls of pores a modification of the governing equation is employed (28) This correction minimizes the apparent dependence of SSA on air pressure. Although this method has not been extensively used on granulations or powders in the pharmaceutical sciences, it has been applied to compressed tablets (29).

## 2.8. Granule Porosity

Mercury intrusion methods are routinely applied in the determination of pore size and distribution to both granulations and tablet compacts (30). In this method, excess pressure is applied to a nonwetting liquid, such as mercury, for the smallest

pores to be filled. A relation between the applied pressure and pore radius, known as the Washburn equation Eq. 2.3 is then used to calculate pore size opening

$$\Delta P = -\left(\frac{2\gamma}{r}\right)\cos\theta \quad (2.3)$$

where  $\Delta P$  = pressure difference across interface,  $\gamma$  = surface tension of the penetrating liquid,  $\theta$  = contact angle of the penetrating liquid, and  $r$  = pore radius.

In this analysis (2), the sample is introduced into the chamber, degassed, and then completely covered with mercury. Pressure is incrementally applied, and the volume of mercury that penetrates into the pores is recorded. A plot of cumulative volume intruded vs. pressure is obtained and converted to cumulative volume vs. pore radius. The pore size distribution is obtained by differentiating the latter curve.

Wikberg and Alderborn (31) have suggested that increase in intragranular porosity, increases the propensity of the granules to fragment leading to formation of stronger tablets. For granulations, which are less prone to fragmentation, Johansson et al. (32) showed that increased intragranular porosity increased the degree of deformation, resulting in formation of a closer intragranular pore structure during compression and stronger tablets.

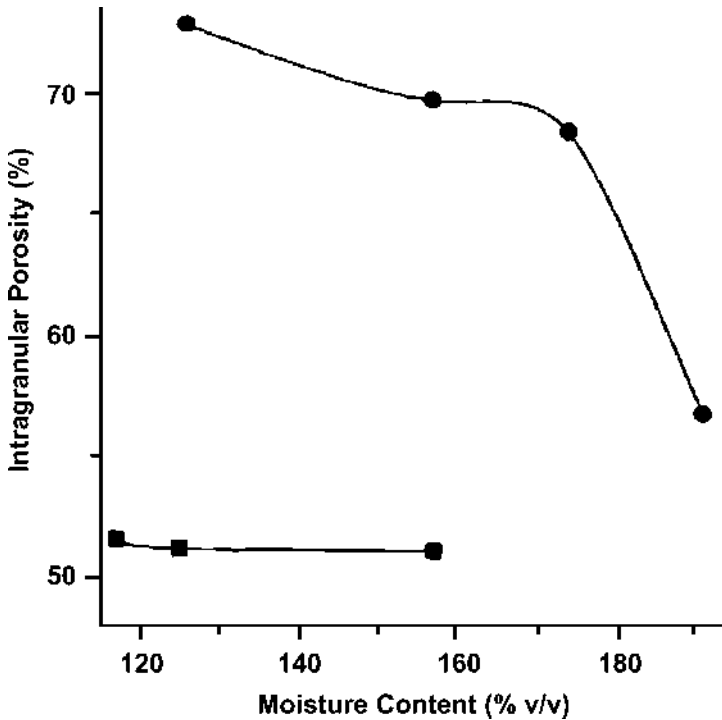
Ganderton and Hunter (6) used mercury intrusion to compare the intragranular porosity of granulations manufactured by different processes. Calcium phosphate was granulated with 10% dextrose–water binder and the comparison was made between a pan granulator and a Z-blade mixer. A plot of intragranular porosity vs. binder level (denoted as moisture content) is shown in Figure 9. A significant decrease in intragranular porosity was observed when massed in a Z-blade mixer and then screened. An opposite trend was noted for lactose granulated with water as a binder. The results of this study suggest that the physicochemical properties of the powder being granulated can have a significant influence on the sensitivity of granule properties to granulation process.

Farber et al. (33) studied the porosity and morphology of granules by two different techniques, x-ray computed tomography (XRCT) and mercury porosimetry (Fig. 10). These authors concluded that XRCT is less accurate in the determination of total porosity when compared to mercury porosimetry. However, XRCT provided detailed morphological information such as pore shape, spatial distribution, and connectivity (Fig. 11).

## 2.9. Granule Strength

The strength of granules is a property that can be measured in the development of a formulation. In a classic treatment of the topic, Rumpf (34) has described numerous mechanisms that contribute to granule and agglomerate strength: (a) solid bridges between particles, (b) interfacial forces and capillary pressure in moveable liquid surfaces, (c) adhesional and cohesive forces in bonding, (d) attraction between solid particles, and (e) particle shape-influenced mechanical interlocking. Rumpf (34) considered the tensile strength of the particle bond to be the most important factor in the determination of agglomerate strength. He proposed a direct test of the tensile strength of agglomerates; although the size of the granules that were tested was  $\approx 2.5$  cm (1 in.) in diameter.

Several methods have been proposed in the pharmaceutical literature for the measurement of the strength of granules. One way of measuring granule strength is

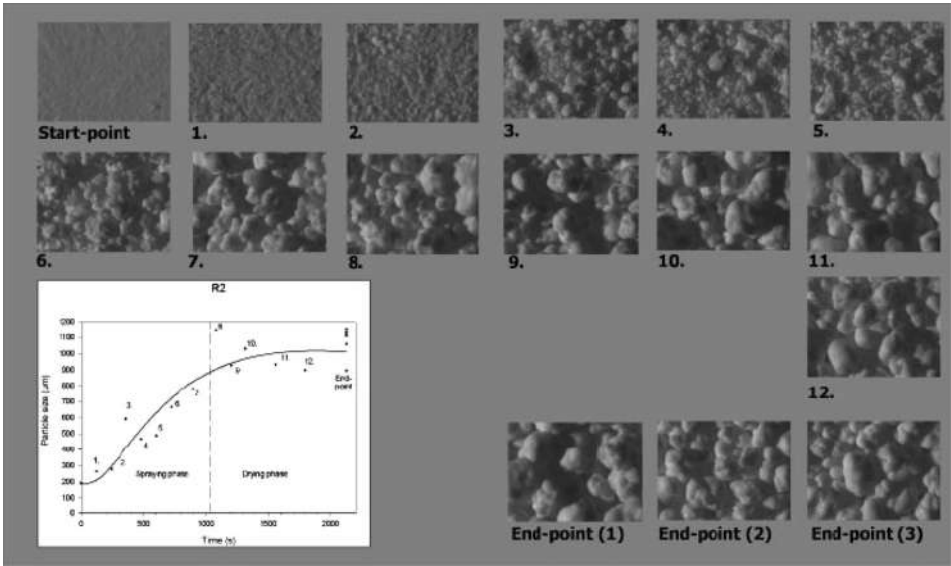


**Figure 9** The effect of moisture content on the porosity of  $-12+16$  mesh calcium phosphate granules processed for 10 min: circles, pan granulated; squares, massed and screened. (From Ref. 6.)

by directly crushing them, a test proposed by Harwood and Pilpel (35) and subsequently modified by both Ganderton and Hunter (6) and Gold et al. (36). The force required to crush the granule is recorded when a platen is moved at a constant strain rate. Deflections in the load profile are interpreted as break points and the strength is recorded in units of mass or force (36). A direct measurement of tensile strength is difficult owing to the lack of understanding of the surface area on which the applied load acts.

Mehta and co-workers (37) have criticized this method because of the inherent variability of the properties of granules as well as for the difficulty in measuring the strength of granules smaller than 40 mesh. Many samples must be measured and results averaged to make the granule-crushing measurement meaningful. In their method, ball milling is used to estimate granule strength by following granule attrition (37). Attrition is monitored using dry sieve analysis. Their method correlated very well with the Harwood-Pilpel method with a much better coefficient of variation for their technique (1–5% for the ballmilling method and 50–80% for the direct-crushing method) (37)

Another attrition method used in determining granule strength is determination of the friability of granulations (38,39). In this measurement, a friabilator is charged with the granulation to be tested and then rotated a set number of times. The percentage loss of mass for a particular size is usually the value that is represented in a granule friability analysis (30,39). This method is useful to identify



**Figure 10** The granule growth of the one of the batch. Each dot (.) shows the data point for the particle mean size measured from the surface image information. Each numbered dot corresponds to the numbered surface images. Additionally, three end-point data points and images are shown together with three replicate data points from end-point sieve analysis (.). The spraying and drying phases of the process are separated with a dashed line. (From Ref. 33.)

properly the differences as a function of granule size within a granulation (39). An example is given for a sulfadiazine granulation in [Figure 12](#).

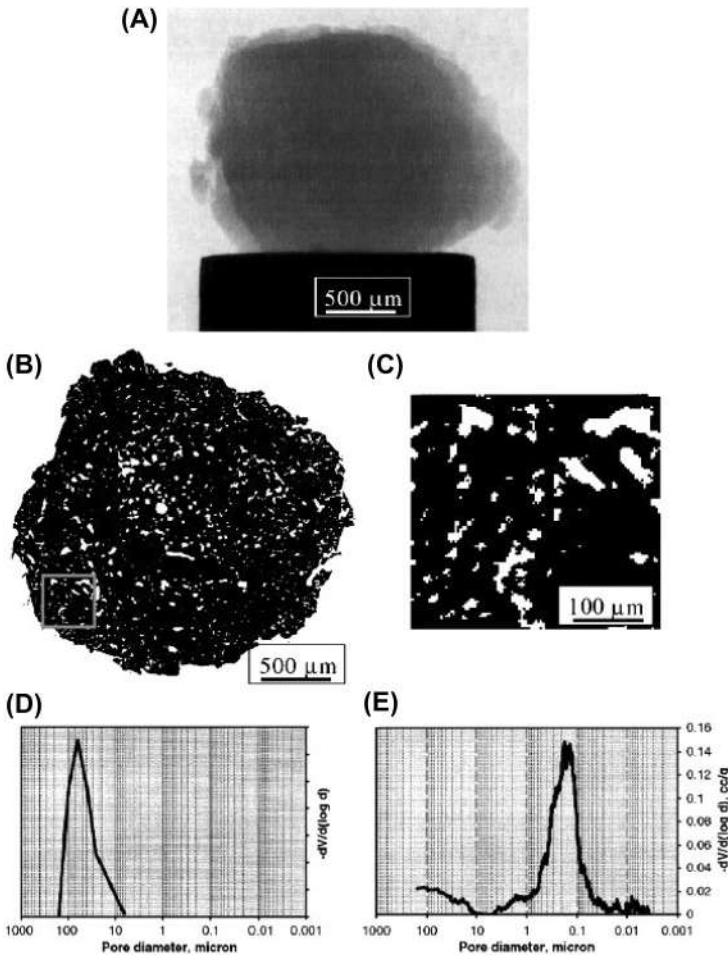
## 2.10. Granule Flowability and Density

Flow behavior of granules is affected by multiple variables such as physical properties of the granulation and the equipment design used for handling during a given process. Prescott and Barnum (40) show the value of selecting flow property measurements that are meaningful to actual processing. Rump and Herrmann (41) and Podczec (42) provide more information on underlying particle properties that contribute to powder flow.

Specific volume is one of the properties of a powder that is believed to affect powder flowability. Specific volume is determined by pouring a known mass of blend into a graduated cylinder. The volume is read off the cylinder and the specific volume is calculated by dividing the volume by the mass of the blend (43). Bulk density is calculated by dividing the mass by volume. The compressibility of a blend can also be determined at this time. The granulated cylinder is vibrated on a shaker for a time period. This vibration reduces the volume that the blend occupies in the graduated cylinder. The percentage compressibility (6) is calculated as in Eq. 2.4

$$\% \text{ Compressibility} = \frac{100 \times (P - A)}{P} \quad (2.4)$$

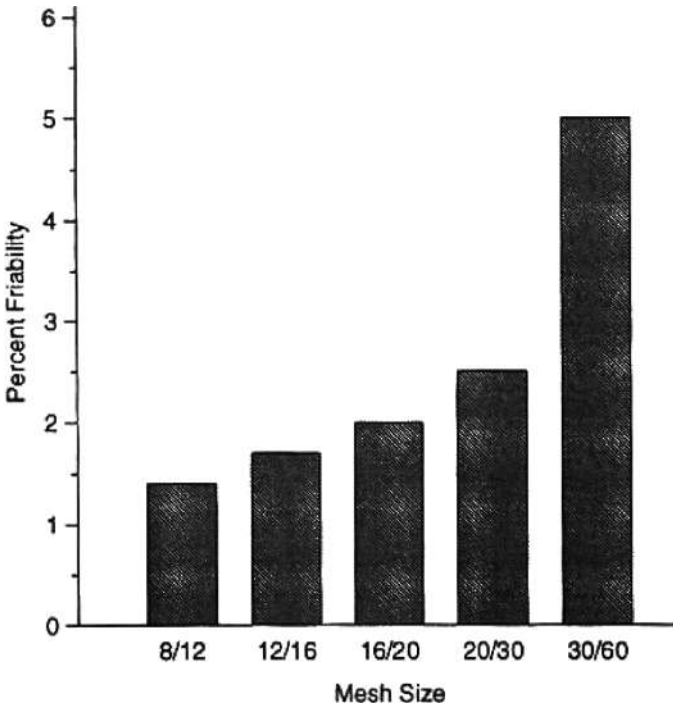
where  $P$  = packed density (after vibration) and  $A$  = bulk density (untapped).



**Figure 11** Tomographic images and pore size distributions of granules produced under high shear in the Fukae mixer. (A) X-ray shadow image; (B) typical reconstructed cross-sectional image; (C) high-magnification image of area in the box in 9b; (D) pore size distribution calculated from tomographic image; and (E) pore size distribution as measured by mercury porosimetry. (From Ref. 33.)

The percentage compressibility is commonly known as Carr's index (44). This index is interpreted in the following way: the higher the compressibility, the poorer the flowability. An example of how this is used in the evaluation of a granulation process was reported by Ertel et al. (45). In this report, the authors evaluated effects of the scale of preparation of a sucrose–lactose–starch granulation using Lodge granulators at the 4 and 30 kg scale. The compressibility of the granulations was dependent on the kneading time as well as the scale of preparation.

Powder flowability can be directly measured using the “flow through an orifice” technique (12,46). This test is close to an actual “use test,” because a hopper is charged with the blend and the flow rate during discharge is measured. A variation of this test is achieved by determining the relation between the flow rate of a blend and the diameter of the orifice. Harwood and Pilpel (35) describe various methods of

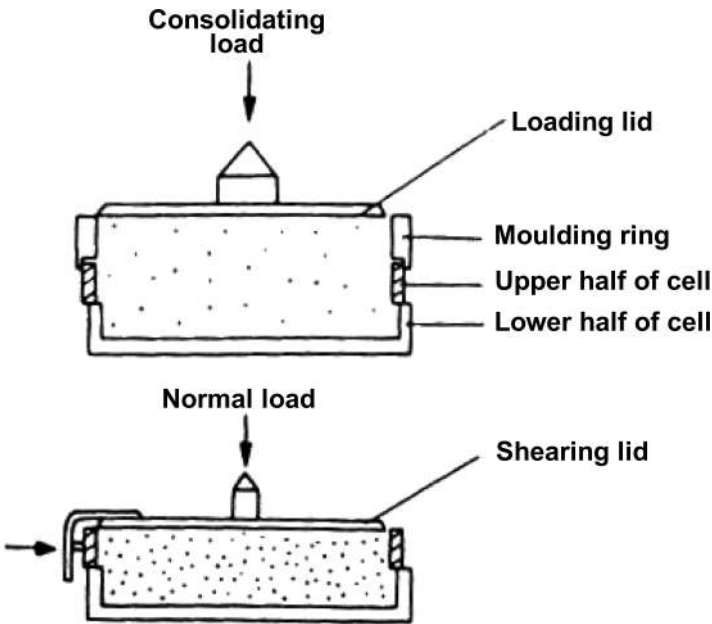


**Figure 12** Friability of sulfadiazine granulations. (From Ref. 39.)

data analysis for this technique in detail. These methods include empirical equations, dimensional analysis, and energy considerations.

A more fundamental evaluation of powder flowability can be obtained by assessing interparticulate friction. The angle of repose is a parameter that is dependent on interparticulate friction and cohesion (47–49). The static angle of repose is obtained by filling an open-ended cylinder with the blend and then slowly raising the cylinder, allowing the powder to flow out. The angle of the heap that is formed is called as the static angle of repose (46). In general, the higher the angle of repose the poorer the flowability of the blend. A dynamic, or kinetic, angle of repose can be obtained by charging a hollow drum with blend and rotating it. The angle of repose can be calculated by recording how high the blend travels up the wall of the drum (46,50). This angle of repose will be 1–5° lower than the static angle (46). However, there are some problems with this technique. Danish and Parrott (47) found that the angle of repose of blends did not correlate with the flow through an orifice data, a result that is in agreement with other authors (36).

A better method for determining the cohesive and frictional effects of particles is by using a shear cell (48,51,52). There are various cell configurations, the most popular proposed by Jenike (51). In the Jenike cell (Fig. 13), a powder is loaded and then compressed by twisting the lid of the cell. The number of twists required to load the powder to the point at which the resistance to shear (measured as stress applied to ring around the bed) is constant. This phase of the test is known as “shear consolidation.” The load is reduced and the resistance to shear is then recorded. A “yield locus” of this shear stress vs. the reduced load is obtained and used to calculate various flow-related parameters (47,48,51). Numerous parameters can be



**Figure 13** Schematic of Jenike shear cell. (From Ref. 48.)

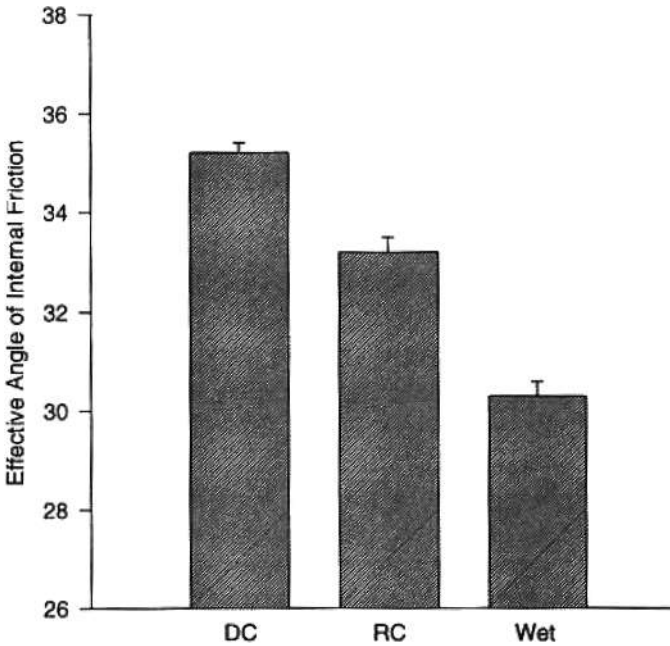
derived from the yield locus: flow factor, shear index, cohesion, tensile strength, effective angle of internal friction, and unconfined yield stress (48). All of these parameters can be used in the characterization of powder flowability.

Other shear cells have been used to characterize the flowability of blends. Carr and Walker describe an annular shear cell that measures the resistance to the angular movement of the shoe that is placed on top of the powder (53). The advantage to this type of design is that unlimited travel of the shoe provides the opportunity to measure successive initial consolidation loads without reloading the powder (53). Hiestand (52) and later on, Amidon and Houghton (54), describe a plate-type shear cell that is similar to the Jenike shear cell, with the exception that the powder bed is unconstrained at the edge of the bed.

Sinko and co-workers (55) have demonstrated the usefulness of the plate-type shear cell in directly measuring the improvement in flowability that is afforded by wet granulation. In this study, the measurement of flowability estimated by the effective angle of internal friction, a parameter that estimates the powder's resistance to shear stress as a function of applied load, was used to track the potential improvement in flowability achieved through dry- and wet-granulation. A comparison of the effective angle of internal friction for a direct compression, wet-granulated, and dry-granulated formulation of near equivalent composition is provided in [Figure 14](#). Wet-granulation resulted in a greater improvement in the flowability of the formulation than a similarly sized dry granulation.

## 2.11. Moisture Control in Granulations

Control of moisture content in granulations is very important and it could affect the physical and chemical performance of final dosage forms. Moisture could affect flow of granules, tablet compression, tablet disintegration, crystal habit, capsule



**Figure 14** The effect of process on the flowability of lactose based granulations: DC, direct compression, RC, roller compaction; Wet, wet granulated. (From Ref. 55.)

brittleness, chemical stability, and many other properties. Moisture content is generally measured using moisture analyzer during product development; a thin layer of sample is heated at a set temperature until it reaches a constant weight and the results are expressed as LOD. Chowhan (56) showed that tablets made using low moisture content granulations when exposed to higher humidity increased in hardness and disintegration. Badawy et al. (57) showed in a processing study the moisture content had the largest effect on compressibility of the granulation compared to seven other process parameters. Within the tested levels increasing moisture content increased the granulation compressibility. It should be noted that due to the great diversity of granulation formulation, one has to characterize each of their formulation and process to evaluate the moisture effect on physical and chemical properties.

Some polymorphic transitions in granulations are moisture mediated. Wostheinrich and Schmidt (58) showed that thiamine hydrochloride granulations were caking on storage and the tablets were increasing in hardness due to conversion of form I crystal to hydrate forms due to exposure to humidity at room temperature. Williams et al. (59) indicated that the active ingredient which is highly crystalline hydrochloride form was dissociated in minute quantities (1% of tablet weight) into amorphous free form due exposure to moisture and altering tablet properties. Minimizing moisture exposure during process and storage was recommended.

It is ideal to develop equilibrium moisture isotherms for granulations to understand the moisture content at different humidities. To develop moisture isotherms granulations are exposed to different relative humidities at a set temperature and the equilibrium moisture content is determined. This information could be used to develop specifications for the moisture content of the granulation and would help device ideal processing and packaging conditions. One application of moisture



isotherms data could be applied to the formulation development of capsules. Capsules show brittleness at low relative humidity and a tendency to cross-link at high humidity and high temperature. Adsorption-desorption moisture transfer model was developed by Zografi et al. (60) to predict moisture transfer between excipients, and this model was used later to control brittleness of capsules successfully by Kotny et al. (61) and Chang et al. (62).

### 3. CONCLUSION

The diverse nature of formulations and processes are used to manufacture granulations calls for various tools that are needed to help characterize granule properties. The tools mentioned in this chapter could be used as a guide for the formulation-process scientist during research and development stages. There are also several other sophisticated tools (like Raman imaging) still being evaluated for specific characterization of the granulation like uniformity of drug distribution.

### REFERENCES

1. Sinko C. Granulation characterization: methods and significance. Parikh DM, ed. *Handbook of Pharmaceutical Granulation Technology*. New York: Marcel Dekker, 1997.
2. Brittain HG, Bogdanowich SJ, Bugay DE, DeVincentis J, Lewen G, Newman AW. Physical characterization of pharmaceutical solids. *Pharm Res* 1991; 8:963.
3. Ridgeway K, Rupp R. *J Pharm Pharmacol* 1969; 21:30S.
4. Yoshinari T, Forbes RT, York P, Kawashima Y. The improved compaction properties of mannitol after a moisture-induced polymorphic transition. *Int J Pharm* 2003; 258:121.
5. Rupp R. Flow and other properties of granulates. *Bol Chim Farm* 1977; 116:251.
6. Ganderton D, Hunter BM. A comparison of granules prepared by pan granulation and by massing and screening. *J Pharm Pharmacol* 1971; 23:1S.
7. Shergold FA. The effect of sieve loading on the results of sieve analysis of natural sands. *J Soc Chem Ind* 1946; 65:245.
8. Fonner DF, Banker GS, Swarbrick J. Micromeritics of granular pharmaceutical solids II: factors involved in the sieving of pharmaceutical granules. *J Pharm Sci* 1966; 55:576.
9. Stevens PTA. The relationship between particle size distribution of granules and weight variation of tablets. *Acta Pharm Technol* 1980; 26:304.
10. Byrn S, Pfeiffer R, Ganey M, Hoiberg C, Poochikian G. Pharmaceutical solids: a strategic approach to regulatory considerations. *Pharm Res* 1995; 12:945.
11. Airaksinen S, Karjalainen M, Räsänen E, Rantanen J, Yliruusi J. Comparison of the effects of two drying methods on polymorphism of theophylline. *Int J Pharm* 2004; 276:129.
12. Morris KR, Newman AW, Bugay DE, Randive SA, Singh AK, Szyper M, Varia SA, Brittain HG, Serajuddin ATM. Characterization of humidity-dependent changes in crystal properties of a new HMG-CoA reductase inhibitor in support of its dosage form development. *Int J Pharm* 1994; 108:195.
13. Carstensen JT. *Pharmaceutical Principles of Solid Dosage Forms*. Lancaster, PA: Technomic Publishing, 1993.
14. Hellén L, Yliruusi J, Merkkü P, Kristofferson E. Process variables of instant granulator and spheroniser: I. Physical properties of granules, extrudate, and pellets. *Int J Pharm* 1993; 96:197.
15. Lipps DM, Sakr AM. Characterization of wet granulation process parameters using response surface methodology. I. Top-spray fluidization. *J Pharm Sci* 1994; 83:937.

16. Schaefer T, Wörts O. Control of fluidized bed granulation. III. Effects of inlet air distribution. Control of moisture content of granules in the drying phase. *Arch Pharm Chem Sci Ed* 1978; 6:1.
17. Wong MWY, Mitchell AG. Physicochemical characterization of a phase change produced during the wet granulation of chlorpromazine hydrochloride and its effects on tableting. *Int J Pharm* 1992; 88:261.
18. Ghorab MK, Adeyeye MC. Enhancement of ibuprofen dissolution via wet granulation with beta-cyclodextrin. *Pharm Dev Technol* 2001; 6:305.
19. Perissutti B, Rubessa F, Moneghini M, Voinovich D. Formulation design of carbamazepine fast-release tablets prepared by melt granulation technique. *Int J Pharm* 2003; 256:53.
20. Räsänen E, Rantanen J, Jørgensen A, Karjalainen M, Paakkari T, Ylirussi J. Novel identification of pseudopolymorphic changes of Theophylline during wet granulation using near infrared spectroscopy. *J Pharm Sci* 2001; 90:389.
21. Aldridge PK, Evans CL, Ward HW II, Colgan ST, Boyer N, Gemperline PJ. Near-IR detection of polymorphism and process-related substances. *Anal Chem* 1996; 68:997.
22. Buckton G, Yonemochi E, Hammond J, Moffat A. The use of near infra-red spectroscopy to detect changes in the form of amorphous and crystalline lactose. *Int J Pharm* 1998; 168:231.
23. Gold G, Palermo BT. Hopper flow electrostatics of tableting material I. Instrumentation and acetaminophen formulations. *J Pharm Sci* 1965; 54:310.
24. Chalmers AA, Elworthy PH. Oxtetracycline tablet formulations: effect of variations in binder concentration and volume on granule and tablet properties. *J Pharm Pharmacol* 1976; 28:228.
25. Harwood CF, Pilpel N. Granulation of griseofulvin. *J Pharm Sci* 1968; 57:478.
26. Carmen PC. The determination of the specific surface of powders. I. *J Soc Chem Ind* 1938; 57:225.
27. Brunauer S, Emmett PH, Teller E. Adsorption of gases in multimolecular layers. *J Am Chem Soc* 1938; 60:309.
28. Rigden PJ. The specific surface of powders. A modification of the theory of the air-permeability method. *J Soc Chem Ind* 1947; 66:130.
29. Alderborn G, Duberg M, Nystrom C. Studies on direct compression of tablets X. Measurement of tablet surface area by permeametry. *Powder Technol* 1985; 41:49.
30. Hayes JM, Rossi-Doria P. Principles and Applications of Pore Structural Characterization. Bristol, UK: JW Arrowsmith, 1985.
31. Wikberg M, Alderborn G. Compression characteristics of granulated materials. IV. The effect of granule porosity on the fragmentation propensity and compactibility of some granulations. *Int J Pharm* 1991; 69:239.
32. Johansson B, Wikberg M, Ek R, Alderborn G. Compression behaviour and compactibility of microcrystalline cellulose pellets in relationship to their pore structure and mechanical properties. *Int J Pharm* 1995; 117:57.
33. Farber L, Tardos G, Michaels JN. Use of X-ray tomography to study the porosity and morphology of granules. *Powder Technol* 2003; 132:57.
34. Rumpf H. The strength of granules and agglomerates. Knepper WA, ed. *Agglomeration*. New York: Wiley Interscience, 1962; 379.
35. Harwood CF, Pilpel N. Granulation of griseofulvin. *J Pharm Sci* 1968; 57:478.
36. Gold G, Duvall RN, Palermo BT, Slater JG. Powder flow studies II: effect of glidants on flow rate and angle of repose. *J Pharm Sci* 1996; 55:1291.
37. Mehta A, Zoglio MA, Carstensen JT. Ball milling as measure of crushing strength of granules. *J Pharm Sci* 1978; 67:905.
38. Hill PM. Starch paste granulations: binder dilution effects on granulations and tablets. *J Pharm Sci* 1976; 65:313.
39. Marks AM, Sciarra JJ. Effect of size on other physical properties of granules and their corresponding tablets. *J Pharm Sci* 1968; 57:497.

40. Prescott JK, Barnum RA. On powder flowability. *Pharm Technol* Oct 2000; 60–84.
41. Rumpf H, Herrmann W. Properties, bonding mechanisms, and strength of agglomerates. *Process Prep* 1970; 11:117.
42. Podczec F. Particle-particle adhesion. *Pharmaceutical Powder Handling*. London: Imperial College Press, 1998:256.
43. Lachman L, Lieberman HA, Kanig JL, eds. *Theory and Practice of Industrial Pharmacy*. Philadelphia, PA: Lea & Febiger, 1986.
44. Gordon RE, Rosanske TW, Fonner DE, Anderson NR, Banker GS. Granulation technology and tablet characterization. Lieberman HA, Lachman L, Schwartz JB, eds. *Pharmaceutical Dosage Forms: Tablets*. New York: Marcel Dekker, 1990.
45. Ertel KD, Zoglio MA, Rischel WA, Carstensen JT. Physical aspects of wet granulation IV: effect of kneading time on dissolution rate and tablet properties. *Drug Dev Ind Pharm* 1990; 16:963.
46. Pilpel N. The flow of powders and granular solids. *Br Chem Eng* 1966; 11:699.
47. Danish FQ, Parrott EL. Flow rates of solid particulate pharmaceuticals. *J Pharm Sci* 1971; 60:548.
48. York P. Powder failure testing—pharmaceutical applications. *Int J Pharm* 1980; 6:89.
49. Train D. Some aspects of the property of angle of repose of powders. *J Pharm Pharmacol* 1958; 10:127T.
50. Carr RL. Evaluating the flow properties of solids. *Chem Eng* 1965; 72:163.
51. Jenike AW. Gravity Flow of Solids, Bulletin 108. Salt Lake City, UT: Utah Engineering Experimental Station, University of Utah, 1961.
52. Hiestand EN. The determination of some important physical properties of powders. *Pharm Ind* 1972; 34:262.
53. Carr JF, Walker DM. An annular shear cell for granular materials. *Powder Technol* 1968/1969; 1:369.
54. Amidon GE, Houghton ME. Powder flow testing in preformulation and formulation development. *Pharm Manuf* 1985.
55. Sinko CM, Carlson GT, Beckwith BA. Mechanical property modification of powder. *Proceedings of the First International Particle Technology Forum*, Denver, CO, 1994; 121.
56. Chowhan ZT. Moisture, hardness, disintegration, and dissolution interrelationships in compressed tablets prepared by wet granulation process. *Drug Dev Ind Pharm* 1979; 5:41.
57. Badawy SI, Menning MM, Gorko MA, Gilbert DL. Effect of process parameters on compressibility of granulation manufactured in a high-shear mixer. *Int J Pharm* 2000; 198:51.
58. Wostheinrich K, Schmidt PC. Polymorphic changes of thiamine hydrochloride during granulation and tableting. *Drug Dev Ind Pharm* 2001; 27:481.
59. Williams AC, Cooper VB, Thomas L, Griffith LJ, Petts CR, Booth SW. Evaluation of drug physical form during granulation, tableting, and storage. *Int J Pharm* 2004; 275:29.
60. Zografi G, Grandolfi GP, Kotny MJ, Mendenhall DW. Prediction of moisture of moisture transfer in mixtures of solids: transfer via vapor phase. *Int J Pharm* 1988; 42:77.
61. Kontny MJ, Mulski CA. Gelatin capsule brittleness as a function of relative humidity at room temperature. *Int J Pharm* 1989; 54:79.
62. Chang RK, Raghavan KS, Hussain MA. A study of gelatin capsule brittleness: moisture transfer between the capsule shell and its content. *J Pharm Sci* 1988; 87:556.

# 19

## Bioavailability and Granule Properties

**Sunil S. Jambhekar**

*South University School of Pharmacy, Savannah, Georgia, U.S.A.*

### 1. INTRODUCTION

The most important property of a dosage form is its ability to deliver the active ingredient to the “site of action” in an amount sufficient to elicit the desired pharmacological response. This property of a dosage form has been variously referred to as its physiological availability, biological availability, or bioavailability.

Bioavailability may be defined more accurately as the rate and extent of absorption of a drug from its dosage form into the systemic circulation. Accordingly, the absorption of a drug following intravenous administration is extremely rapid and complete. However, due to convenience and stability problems, drugs are often administered orally in a tablet or capsule dosage form. Therefore, it is imperative that their rate and extent of absorption in individual be known accurately. Furthermore, it is equally important that the factors that influence the rate and extent of absorption of drugs be also known and understood by formulators.

The subject of bioavailability began to receive growing attention as studies showed that the therapeutic effectiveness of a drug from the dosage form depends, to a large extent, on the physiological availability of their active ingredient(s), and is a function of the drug concentration in the patient’s blood or plasma. The importance of bioavailability in drug therapy, therefore, stems from the fact that the rate and extent of absorption of a drug from a dosage form can, in fact, affect the patient’s response to a drug. In light of these facts, the determination of bioavailability has become one of the ways to assess the *in vivo* performance of a dosage form following its formulation development. It must, however, be remembered that bioavailability studies, very often, are conducted in normal, fasted, and a small number of subjects and, therefore, the results of these studies may not always reflect the true efficacy relationship in patients under treatment conditions.

For many years it was assumed that if a dosage form contained the labeled amount of a drug, its performance could be taken for granted. However, it is now evident for some time that many factors acting individually or in concert may produce the therapeutic failure.

## 2. BIOAVAILABILITY PARAMETERS

In assessing the bioavailability of a drug from a dosage form, three parameters are measured following the administration of a drug through a dosage form and obtaining the drug blood concentration time profile (Fig. 1):

1. Peak concentration ( $C_p$ )<sub>max</sub>
2. Peak time,  $t_{max}$
3. The area under the concentration time curve,  $(AUC)_0^\infty$

The parameters  $t_{max}$  and  $(C_p)_{max}$  are the measure of the rate of absorption and the  $(AUC)_0^\infty$  is a measure of the extent of absorption.

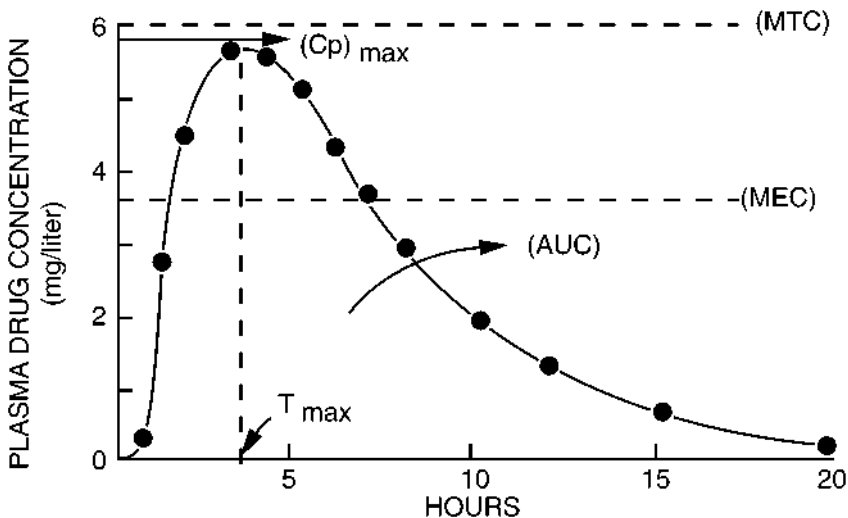
### 2.1. Peak Time

This parameter represents the length of time required to attain the maximum concentration of drug in the systemic circulation. The parameter reflects the onset of action and, hence, can be utilized as a measure of the rate of absorption. The faster the rate of absorption, the smaller the value for the peak time and the quicker the onset of action of the drug. The peak time is determined by using the following equation:

$$t_{max} = \frac{\ln(K_a/K)}{(K_a - K)} \quad (2.1)$$

where  $K_a$  and  $K$  are the first-order absorption and elimination rate constants, respectively.

Eq. 2.1 clearly indicates that larger the value of the absorption rate constant ( $K_a$ ), the smaller is the value of peak time ( $t_{max}$ ) and the quicker is likely to be the onset of action.



**Figure 1** A graphical representation of plasma/serum drug concentration data following the administration of a drug by an extravascular route.

The elimination rate constant ( $K$ ) is constant for a drug in normal healthy individuals and it changes when organs responsible for the elimination of the drug (i.e., kidney and liver) exhibit abnormalities. The absorption rate constant ( $K_a$ ), on the other hand, depends on the route of administration, the dosage form, and the formulation of a drug. And, for hydrophobic drugs or when the absorption is dissolution rate limited, the faster dissolution is generally reflected in the higher value for the absorption rate constant. Therefore, by changing the formulation of a drug or route of administration, one can alter the peak time and, therefore, the rate of absorption and time for the onset of action.

## 2.2. Peak Plasma Concentration ( $C_p$ )<sub>max</sub>

This parameter represents the highest drug concentration in the systemic circulation or the plasma concentration that corresponds to the peak time. Furthermore, this parameter is often associated with the intensity of the pharmacologic response of the drug. Therefore, the peak plasma concentration (Fig. 1) of a drug following the administration of a dosage form should be above the minimum effective concentration and below the minimum toxic concentration. The peak plasma concentration can depend on the absorption rate constant ( $K_a$ ) and the fraction of the administered dose that eventually reaches the systemic circulation. The higher the absorption rate constant and fraction that reaches the general circulation, the greater is the peak plasma concentration for the administered dose. The route of administration, the dosage form, and the formulation can therefore influence the peak plasma concentration. It is determined by using the following method:

$$(C_p)_{\max} = \frac{K_a F (X_a)_0}{V(K_a - K)} (e^{-kt_{\max}} - e^{-k_a t_{\max}}) \quad (2.2)$$

where  $F$  is the fraction of the dose that eventually reaches the systemic circulation,  $(X_a)_0$  is the administered dose,  $V$  is the apparent volume of distribution of a drug, and  $t_{\max}$  is the peak time.

Since the term  $(K_a F (X_a)_0) / (V(K_a - K))$  in Eq. 2.2 constitutes the intercept of the plasma concentrations against the time profile, Eq. 2.3 can be written as

$$(C_p)_{\max} = I(e^{-kt_{\max}} - e^{-k_a t_{\max}}) \quad (2.3)$$

where  $I$  is the intercept ( $\mu\text{g}/\text{mL}$ ) of the plasma concentrations against time profile.

## 2.3. Area under the Plasma Concentration Time Curve

This parameter represents the extent of absorption of a drug following the administration of a dosage form. The greater the fraction of the dose that reaches the general circulation the greater is the extent of the absorption and, hence,  $(\text{AUC})_0^\infty$ . The term  $(\text{AUC})_0^\infty$ , expressed as  $\mu\text{g}/\text{mL}/\text{hr}$ , for a drug following its administration by various extravascular routes or various dosage forms that are administered extravascularly, is determined by employing the following equation:

$$(\text{AUC})_0^\infty = \frac{K_a F (X_a)_0}{V(K_a - K)} \left[ \frac{1}{K} - \frac{1}{K_a} \right] \quad (2.4)$$

All the terms of the Eq. 2.4 have been defined previously. Eq. 2.4 can further be reduced to

$$(\text{AUC})_0^\infty = \text{Intercept} \left[ \frac{1}{K} - \frac{1}{K_a} \right] \quad (2.5)$$

the intercept in Eq. 2.5 being the intercept of the plasma concentration time profile. The extent of absorption can also be determined by using the following equation:

$$(\text{AUC})_0^\infty = \frac{F(X_a)_0}{VK} \quad (2.6)$$

where, the term  $VK$  is the systemic clearance of the administered drug. This parameter being independent of the route of administration, the formulation, and the extravascularly administered dosage form, it is ostensible that the extent of absorption [i.e.,  $(\text{AUC})_0^\infty$ ] is controlled by the product of the fraction of the administered dose reaching the general circulation and the administered dose [i.e.,  $F(X_a)_0$ ].

## 2.4. Factors Affecting the Bioavailability

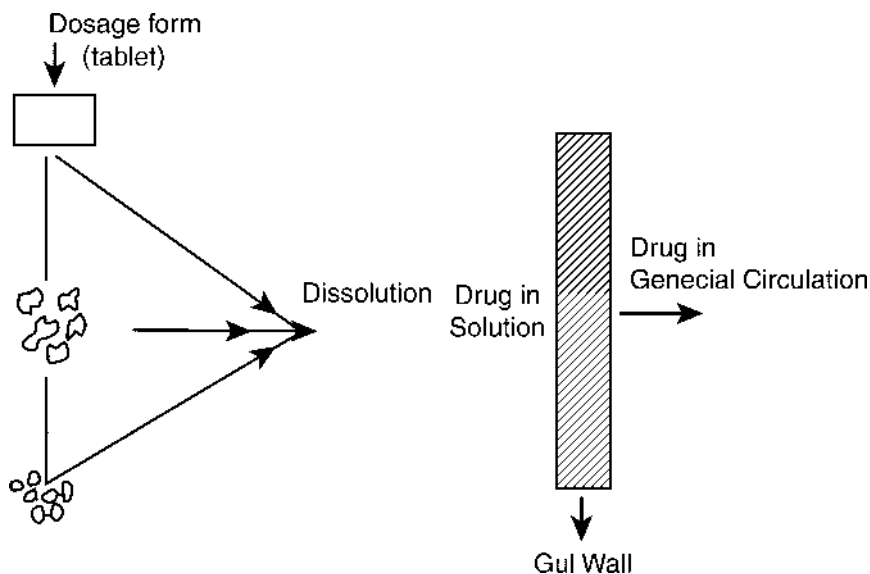
There are a number of factors responsible for the variation in bioavailability. Broadly speaking, these factors can be classified as patient related or dosage form related. Patient related factors include age, disease state, abnormal genetic characteristics, and gastrointestinal physiology. The detailed discussion on these factors is beyond the scope of the objectives of this chapter.

Dosage form related factors include formulation and manufacturing related variables such as particle size, type, and quantity of excipient used, method of manufacturing, compression pressure, derived properties of the powder, and many other factors.

The fact that the bioavailability of a drug may be significantly affected by its physical state of the drug and the dosage forms via which it is administered has been unequivocally demonstrated. And, because drugs are administered through dosage forms, these dosage forms should have adequate stability, consistent bioavailability, and uniform composition.

Following the administration of a drug through a solid dosage form, a sequence of steps are required before the drug reaches the systemic circulation. As shown in Figure 2, an orally administered solid dosage form undergoes disintegration and deaggregation, followed by the dissolution of the drug. The dissolved drug molecules must penetrate the gastrointestinal membrane and picked up by the blood. Each of the steps involved may limit how fast the drug molecules reach the general circulation and, therefore, site of action. The step that offers the maximum resistance is referred to as the rate-limiting step. Which step will be rate limiting, on the other hand, will depend on the physicochemical properties of the dosage form and the physiology of the gastrointestinal tract. The focus of the discussion here, however, will be on the physicochemical properties of the dosage form.

As illustrated in Figure 2, solid dosage form must disintegrate or deaggregate before much of the drug is available for absorption. Drug dissolution subsequently occurs from the resulting granules. Therefore, the properties of granules are important in understanding how dissolution is influenced by these properties. Following the ingestion of a solid dosage form, whether or not a drug is deaggregated, it will not be absorbed until it has dissolved into the luminal fluids of the gastrointestinal tract. Because of the effects of disintegration and deaggregation on the dissolution, the remaining discussion will focus on the factors influencing the dissolution of the drug.



**Figure 2** Schematic representation of the process of the drug dissolution and its entry into the general circulation.

## 2.5. Dissolution and Granule Properties

Amongst available dosage forms, compressed tablets are the most widely used dosage form. Tablets are generally obtained by using either wet granulation or direct compression process. Wet granulation process consists of mixing a drug with other powdered material and wetting the mixture with an aqueous or hydroalcoholic solution of a suitable binder such as gelatin, starch, or polyvinylpyrrolidone. The damp mass is passed through the screens of 8–12 mesh and dried to produce cohesive granules. Each granule, in theory, is a blend of an active ingredient and excipients. The granules flow easily through the hopper into the tablet press and are easily compressed.

Many derived properties of the powder greatly influence the granule properties, which, in turn, influence the dissolution of an active ingredient from the dosage form. These derived properties include powder density, porosity, specific surface, particle number, and powder flow. These derived properties are, in essence, determined by the particle size and size distribution. Consequently, particle size and size distribution play a vital role in influencing the bioavailability of drugs, particularly, when dissolution is the rate-limiting step in the absorption process. The important role these properties play in influencing the bioavailability must, therefore, be recognized and taken into consideration during optimization of a dosage form formulation. For example, a smaller particle size is desirable, if the drug is hydrophobic, to improve the drug dissolution due to increased specific surface; however, too small a particle size may adversely affect the powder flow and content uniformity of a dosage form. Other derived powder properties like true and bulk density and particle size will play an important role in the mixing of powder blends, prior to granulation and compression. Powder flow is another derived property of importance. Flow of the powder and granules can present difficulties in the manufacturing of a tablet



dosage form, which, in turn, can affect the content uniformity of a drug and the bioavailability.

Many processes used in the tablet manufacturing greatly influence the dissolution rates of the active ingredient. The method of manufacture, the size, the moisture content, age and the flow property of the granules, the order of mixing of ingredients during the granulation, as well as the compression force employed in the tableting process, all contribute to the dissolution characteristics of the final product and, therefore, may be the bioavailability of a drug from the finished product.

Several studies have demonstrated that the granulation process, in general, enhances the dissolution rate of poorly soluble drugs (1). The use of diluents and fillers such as starch (2), anhydrous (3) and spray dried lactose (4,5), microcrystalline cellulose (6), and compression force, particle size and lubricants (7) tends to enhance the hydrophilicity of the active ingredients and improve their dissolution characteristics. In this regard, the wet granulation procedure was considered a superior method compared to other methods. However, newer tableting machines and excipients, accompanied by careful formulation and proper mixing sequence, will permit preparation of tablets with good dissolution characteristics and not dictated by the method of preparation per se.

Marlow and Shangraw (8) reported that sodium salicylate tablets prepared by direct compression with spray dried lactose uniformly exhibited more rapid and complete dissolution compared to those prepared by wet granulation. Furthermore, it was reported that the presence of disintegrate in the dry compression was essential for good dissolution. Finholt et al. (9) reported, in a separate comparative study, utilizing phenobarbital tablets that were manufactured by both wet and dry granulation that both procedures yielded comparable dissolution rates provided a disintegrate was incorporated and mixed with drug before dry granulation. However, the incorporation of disintegrate following the dry granulation of a drug resulted in slower dissolution rates.

In the manufacturing of tablets by the conventional wet granulation method, there are many independent factors that affect the property of granules and, therefore, the dissolution rate. Recent advances in granulation technology and the employment of high-shear mixers and fluid bed granulating equipment have helped to identify several critical in-process variables. The systematic control of variables such as the type and time of mixing of the granules, time and temperature of drying, blending time with lubricant, age of the granules, moisture content of the granules at the time of compression, and the tablet crushing strength are of importance to ensure the consistency in the dissolution and, hence, bioavailability.

In early studies on the physics of tablet compression, Higuchi et al. (10) recognized the influence of compressional forces employed in the tableting process on the apparent density, porosity, hardness, disintegration time, and average particle size of the compressed tablets. Hardness is a measure of resistance of a dosage form to the mechanical deforming. It is a function of high compression forces used in the manufacturing, and it may change with the aging of granules. Higuchi et al. (10) reported a linear relationship between hardness and the logarithm of the compressional force, and the specific surface of the compressed tablets was found to undergo marked changes during the compressional process. The high compression may increase the specific surface and, hence, may enhance the dissolution. On the other hand, the high compression may also inhibit the wettability of a tablet due to the formation of a firmer and more effective sealing layer of the lubricant due to high pressure and temperature that accompany a strong compressional force. Levy et al. (2) reported

that salicylic acid tablets, when prepared by double compression, showed an increase in the dissolution with an increase in the pre-compression pressure due to fracturing of drug particles at higher pressure. The higher compression may also produce slower dissolution, at least in the initial period, due to an increased difficulty of fluid penetration into the compressed tablets. Luzzi et al. (11) and Jalsenjak (12) observed the dissolution rate of sodium phenobarbital to be inversely proportional to the hardness from tablet and microcapsule, respectively.

Another important granule property that influences the dissolution of drug is the moisture content of the granule at the time of compression. Chowhan et al. (13–17) studied the effect of moisture content and crushing strength on ticlopidine hydrochloride tablet friability and dissolution. It was observed (16) that at the moisture content of 1–2%, the drug dissolution was inversely related to the tablet crushing strength. However, at the moisture content level of 3–4%, there was no clear relationship between the dissolution and the crushing strength.

In later studies by Chowhan et al. (14,17), it was reported that the granules prepared by high-speed shear mixer were less porous than those prepared by planetary mixer, and the porosity of the tablet may improve the dissolution of drug by facilitating solvent penetration provided the entrapment of air in the pores is minimized or avoided.

In yet another important study, Levy et al. (2) studied the effect of the granule size on the dissolution rate of salicylic acid tablets and found that the dissolution rate increased with a decrease in the granule size; the increase in dissolution rate, however, was not proportional to the increase in the apparent surface area of the granules. Furthermore, it was also reported that the dissolution rate decreased significantly with the increase in the age of the granules.

The chemical components of the formulation have also been shown to prolong disintegration time, which subsequently affect the drug dissolution and bioavailability. Inert fillers have been found to potentiate the chemical degradation of active ingredient causing alteration in the disintegration and dissolution time of compressed tablets to change with storage. Alam and Parrott (18) have shown that hydrochlorothiazide tablets, granulated with acacia and stored at temperatures ranging from room temperature to 80°C increased in hardness with time. This was reflected in increased disintegration and dissolution time. On the other hand, tablets granulated with starch and polyvinylpyrrolidone did not show any change in disintegration and dissolution time.

### 3. CONCLUSION

Drug availability following the oral dosing may be thought of as the result of the following steps:

1. Getting the drug into solution.
2. Moving the drug molecules through the membrane of the gastrointestinal tract.
3. Moving the drug away from the site of administration into the general circulation.

It is clear from the discussion that the bioavailability of drugs, particularly poorly soluble drugs, mainly depends on the ability of the drug to dissolve at the site of administration. The dissolution, in turn, especially from solid dosage forms such

as tablet and capsule, depends on the powder properties, granule properties, and the processing variables used in the manufacture of the dosage forms. The granule properties and other variables, which determine and influence the granule properties, will serve as major topics of discussion in subsequent chapters. Knowledge of these factors and their role in influencing the bioavailability of a drug will allow the formulators to develop an optimum drug dosage form by selecting the process and preparation variables involved in a rational manner.

## REFERENCES

1. Solvang S, Finholt P. Effect of tablet processing and formulation factors on dissolution rates of active ingredient in human gastric juice. *J Pharm Sci* 1970; 59:49–52.
2. Levy G, Antkowiak J, Procknal J, White D. Effect of certain tablet formulation factors on dissolution rate of the active ingredient II: granule size, starch concentration, and compression pressure. *J Pharm Sci* 1963; 52:1047–1051.
3. Batuyios N. Anhydrous lactose in direct tablet compression. *J Pharm Sci* 1966; 55:727–730.
4. Gunsel W, Lachman L. Comparative evaluation of tablet formulations prepared by conventionally processed and spray dried lactose. *J Pharm Sci* 1963; 52:178–182.
5. Duvall R, Koshy K, Dashiell R. Comparative evaluation of dextrose and spray dried lactose in direct compression systems. *J Pharm Sci* 1965; 54:1196–1200.
6. Reier G, Shangraw R. Microcrystalline cellulose in tableting. *J Pharm Sci* 1966; 55:510–514.
7. Iranloye T, Parrott E. Compression force, particle size, and lubricants on dissolution rates. *J Pharm Sci* 1978; 67:535–539.
8. Marlow E, Shangraw R. Dissolution of sodium salicylate from tablet matrices prepared by wet granulation and direct compression. *J Pharm Sci* 1967; 56:498–504.
9. Finholt P, Pedersen P, Solvang R, Wold K. *Medd Norsk Farm Selsk* 1966; 28:238.
10. Higuchi T, Rao A, Busse E, Swintosky J. The physics of tablet compression II: the influence of degree of compression on properties of tablets. *Am Pharm Assoc Sci Ed* 1953; 42:194–200.
11. Luzzi L, Zoglio M, Maulding H. Preparation and evaluation of the prolonged release properties of nylon microcapsules. *J Pharm Sci* 1970; 59:338–341.
12. Jalsenjak I, Nicolaidou C, Nixon J. Dissolution from tablets prepared using ethylcellulose microspheres. *J Pharm Pharmacol* 1977; 29:169–172.
13. Chowhan ZT, Palagyi L. Hardness increase induced by partial moisture loss in compressed tablets and its effect on in vitro dissolution. *J Pharm Sci* 1978; 67:1385–1389.
14. Chowhan ZT. Moisture, hardness, disintegration and dissolution interrelationships in compressed tablets prepared by the wet granulation process. *Drug Dev Ind Pharm* 1979; 5(1):41–62.
15. Chowhan ZT. Role of binders in moisture-induced hardness increase in compressed tablets and its effect on in vitro disintegration and dissolution. *J Pharm Sci* 1980; 69:1–4.
16. Chowhan Z, Yang I, Amaro A, Chi L. Effect of moisture and crushing strength on tablet friability and in vitro dissolution. *J Pharm Sci* 1982; 71:1371–1375.
17. Chowhan Z, Chatterjee B. A method for establishing in process variable controls for optimizing tablet friability and in vitro dissolution. *Int J Pharm Technol Prod Manuf* 1984; 5(2):6–12.
18. Alam AS, Parrott EL. Effect of aging on some physical properties of hydrochlorothiazide tablets. *J Pharm Sci* 1971; 60:263–266.

**RECOMMENDED READING**

- Abdou HM. Dissolution, Bioavailability and Bioequivalence. Easton, PA: Mack Publishing Company, 1989.
- Blanchard J, Sawchuk R, Brodie B, eds. Principles and Perspectives in Drug Bioavailability. Basel, Switzerland: S. Krager AG, 1979.
- Gibaldi M. Biopharmaceutics and Clinical Pharmacokinetics. 4th. Philadelphia, PA: Lea and Febiger, 1991.
- Jambhekar S. Micromeritics and rheology. In: Ghosh and Jasti, eds. Theory and Practice of Contemporary Pharmaceutics. Boca Raton, FL: CRC Press. In press.
- Leeson LJ, Carstensen J, eds. Dissolution Technology. Washington, DC: Academy of Pharmaceutical Sciences, 1974.
- Stavchansky SA, McGinity JW. Bioavailability. In: Lieberman HA, Lachman L, Schwartz JB, eds. Tablet Technology Pharmaceutical Dosage Forms: Tablets. Vol. 2. 2nd ed. New York: Marcel Dekker, Inc., 1990.

# 20

## Process Analytical Technology

**D. Christopher Watts and Ajaz S. Hussain**

*Office of Pharmaceutical Science, Center for Drug Evaluation and Research,  
Food and Drug Administration, Bethesda, Maryland, U.S.A.*

### 1. INTRODUCTION

Pharmaceutical granulation is a critical unit operation that is frequently utilized to modulate attributes of powder mixtures to aid in further processing (e.g., compaction or encapsulation), as today few pharmaceutical products are granules. The granulation processes must be designed to impart a high degree of control on many important physical attributes, such as granule size distribution, shape, content uniformity, moisture content and distribution, porosity, density, tensile strength, and surface morphology. These physical attributes are often critical to process-ability of granulations and for final product quality and performance (e.g., content uniformity, dissolution, stability, and bioavailability). An optimally designed granulation unit operation can be an excellent tool for minimizing variability and thereby reducing the risk of poor quality. Traditionally, granulation has been utilized to manage lot–lot and supplier–supplier variability in the physical attributes of pharmacopieal materials—excipients and drug substances.

Over the last three decades significant scientific and technological advances have occurred in pharmaceutical granulation processes. During this period, the practice of pharmaceutical granulation, especially wet granulation, has made significant progress in moving from an art to a more science and engineering foundation. If we use “granulation end point” in wet granulation as a gauge to measure this progress, the practice of granulation end point moved from an operator dependent evaluation (i.e., observing the behavior of a hand compacted mass) to a time dependent end point and, in some cases, a more predictive end-point criteria. The next few steps in this evolutionary process can be envisioned to be robust metrics of granule functionality, the ability to predict optimal granulation processing conditions and end points from an understanding of the attributes of raw materials and feed-forward control. Furthermore, a mechanistic understanding the granulation process and the ability to predict the impact of granule properties on product performance seems to be a worthy and achievable goal in the near future.

The objectives of this chapter are to discuss the FDA’s Process Analytical Technology (PAT) framework using selected literature examples on granulation

operations. This discussion is primarily to illustrate certain aspects of the PAT definition and tools. As outlined in the draft guidance, “Process Analytical Technology (PAT) is defined as a system for designing, analyzing, and controlling manufacturing through timely measurements (i.e., during processing) of critical quality and performance attributes of raw and in-process materials and processes with the goal of ensuring final product quality” (1). It should be noted that the primary motivation of PAT is to understand manufacturing processes through identification of all relevant sources of variability and their impact on product quality, in order to design and develop monitoring and control strategies to minimize variability in the final product. Therefore, the term analytical in PAT is viewed broadly to include chemical, physical, microbiological, mathematical, and risk analysis conducted in an integrated manner. Simply, analytical is interpreted as “analytical thinking,” not only chemical analysis.

The focus on process understanding comes from the basic tenet of building, not testing, quality into products. This is a fundamental tenet championed by Deming, Juran, and others (2,3). It is important to emphasize that considering any unit operation (granulation or otherwise) in isolation from the entire manufacturing process would be incomplete in meeting the desired product quality attributes, as each procedure in the manufacturing process should be directed at meeting the needs of subsequent manufacturing operations and, ultimately, final product quality. For example, how do attributes of the raw materials and the blend (assuming this unit operation precedes granulation), and the inherent variability in these attributes impact an optimal granulation process and end point? This is a critical question to be addressed as one designs a granulation process and its control strategy. Equally important is the question: what are the critical attributes of the granules for their subsequent processing and final product quality?

## 2. BACKGROUND

At the July 2001 meeting of the FDA’s Advisory Committee for Pharmaceutical Science (ACPS), the Office of Pharmaceutical Science proposal to facilitate application of modern pharmaceutical engineering principles and new technologies in pharmaceutical development and manufacturing received an enthusiastic endorsement by the ACPS (4). This proposal was further elaborated and discussed at the November 2001 and April 2003 meetings of the Science Board to the FDA (5,6), and once again, received strong support. These meetings were the beginning of the FDA’s PAT Initiative and the broader *CGMP’s for the 21st Century Initiative: A Risk-Based Approach* (7,8). The PAT Initiative was further developed through public discussions at the PAT—Subcommittee of ACPS and numerous scientific conferences and workshops such as the American Association of Pharmaceutical Scientists (AAPS) Arden House, International Forum on Process Analytical Chemistry (IFPAC), International Society of Pharmaceutical Engineers (ISPE), and Parenteral Drug Association (PDA). These discussions led to the development of the final FDA guidance “PAT—A Framework for Innovative Pharmaceutical Manufacturing and Quality Assurance” (1). The following section from the final guidance provides an excellent summary of the issues FDA is trying to address with its initiatives.

Conventional pharmaceutical manufacturing is generally accomplished using batch processing with laboratory testing conducted on collected samples to ensure

quality. This conventional approach has been successful in providing quality pharmaceuticals to the public. However, today significant opportunities exist for improving the efficiency of pharmaceutical manufacturing and quality assurance through the innovative application of novel product and process development, process controls, and modern process analytical chemistry tools. Unfortunately, the pharmaceutical industry generally has been hesitant to introduce new technologies and innovative systems into the manufacturing sector for a number of reasons. For example, one reason often cited is regulatory uncertainty, which may result from the perception that our existing regulatory system is rigid and unfavorable to the introduction of new technologies. In addition, a number of scientific and technical issues have been raised as possible reasons for this hesitancy. Nonetheless, industry's hesitancy to broadly implement new pharmaceutical manufacturing technologies is undesirable from a public health perspective. The health of our citizens and animals in their care depends on the availability of safe, effective, and affordable medicines. Efficient pharmaceutical manufacturing is a critical part of an effective U.S. health care system.

In the future, pharmaceuticals will have an increasingly prominent role in health care. Pharmaceutical manufacturing will need to employ innovation, cutting edge scientific and engineering knowledge, along with the best principles of quality management to respond to the challenges of new discoveries (e.g., novel drugs and nanotechnology) and ways of doing business (e.g., individualized therapy, genetically tailored treatment). Regulatory policies must also rise to the challenge.

In August 2002, recognizing the need to free industry from its hesitant perspective, the FDA launched a new initiative entitled *Pharmaceutical cGMPs for the 21st Century: A Risk-Based Approach*. This initiative has several important goals, which ultimately will help improve the American public's access to quality health care services. The goals are intended to ensure that:

- The most up-to-date concepts of risk management and quality systems approaches are incorporated into the manufacture of pharmaceuticals while maintaining product quality.
- Manufacturers are encouraged to use the latest scientific advances in pharmaceutical manufacturing and technology.
- The Agency's submission review and inspection programs operate in a coordinated and synergistic manner.
- Regulations and manufacturing standards are applied consistently by the Agency and the manufacturer, respectively.
- Management of the Agency's Risk-Based Approach encourages innovation in the pharmaceutical manufacturing sector.
- Agency resources are used effectively and efficiently to address the most significant health risks.

Pharmaceutical manufacturing continues to evolve with increased emphasis on science and engineering principles. Effective use of the most current pharmaceutical science and engineering principles and knowledge—throughout the life cycle of a product—can improve the efficiencies of both the manufacturing and regulatory processes. This FDA initiative is designed to do just that by using an integrated systems approach to regulating pharmaceutical product quality. The approach is based on science and engineering principles for assessing and mitigating risks related to poor

product and process quality. In this regard, the desired future state of pharmaceutical manufacturing may be characterized as follows:

1. Product quality and performance are ensured through the design of effective and efficient manufacturing processes.
2. Product and process specifications are based on a mechanistic understanding of how formulation and process factors affect product performance.
3. Continuous real-time quality assurance.
4. Relevant regulatory policies and procedures are tailored to accommodate the most current level of scientific knowledge.
5. Risk-based regulatory approaches recognize:
  - The level of scientific understanding of how formulation and manufacturing process factors affect product quality and performance.
  - The capability of process control strategies to prevent or mitigate the risk of producing a poor-quality product.

### 3. PAT AND PROCESS UNDERSTANDING

The PAT framework is intended to support innovation and efficiency in pharmaceutical development, manufacturing, and quality assurance. It utilizes process understanding as its foundation to facilitate innovation by industry and risk-based regulatory decisions. For processes that are well understood, significant reduction in regulatory requirements for both CMC review and cGMP inspection may be realized. In the context of granulation one can describe three levels of process understanding: (1) all critical sources of variability in quality and performance are identified and explained; (2) material and process variability is managed by the process design; and (3) quality attributes of the granulation and the final product can be accurately and reliably predicted. Ultimately, the ability to accurately and reliably predict product quality attributes, for example via mathematical models, may be considered to reflect a high degree of process understanding.

Obtaining an increased understanding of the granulation process requires a multidisciplinary approach, combining expertise and scientific principles from several fields, including material science, pharmaceuticals, engineering, and mathematics. The process knowledge should grow when organized knowledge management programs are instituted to collect appropriate information over the life cycle of a specific product and from information gathered from development and manufacturing experience of other products. The following expression is an initial attempt that brings many of the key elements (i.e., design, predictability, and capability) that provide a basis for assessing process understanding (PU) in a summary form. The triple integration function is utilized to symbolize the need for integration across: (1) scientific disciplines, (2) across organizations, and (3) over time (life cycle).

$$PU = \iiint (Design)^*(Predictability)^*(Capability)$$

Successful implementation of the PAT framework will require cooperation and collaboration across scientific disciplines and divisions within an organization such as R&D, manufacturing, quality, and information/knowledge management. Such



cooperation and collaboration within the FDA organization is also necessary for science and risk-based regulatory decisions; hence, the FDA established a team approach for review and inspection for PAT (the FDA PAT Team).

## 4. PAT TOOLS AND THEIR APPLICATION

There are a variety of tools available to facilitate increased understanding and provide an integrated, systems approach to measuring, analyzing, optimizing, controlling, and modeling of the granulation process. Many of these tools are well established and utilized frequently in many industrial sectors, and are beginning to find wider utility in the pharmaceutical industry.

### 4.1. Multivariate Tools for Design, Data Acquisition, and Analysis

Pharmaceutical products are complex multifactorial systems; consequently, the “one-factor-at-a-time” approach to experimentation is often insufficient for identifying and addressing interactions between product and process variables. When attempting to identify the critical product and process variables with significant effects on final product quality, a statistically sound experimental design is essential. Having a sound experimental design not only increases the efficiency of experimentation, but also identifies interactions of the variables, providing opportunities to efficiently and accurately identify the “best” product and process parameters with various optimization techniques.

For example, pharmaceutical companies that utilize structured design of experiments are not only likely to develop robust product and processes, but are also able to clearly articulate why certain variables are critical and justify acceptable ranges for these critical variables to ensure quality. This approach is often essential to minimize manufacturing problems during routine production, especially for processes that have a fixed time as end point. Although the frequently used “fixed granulation time” provides a means to demonstrate “process validation” in the conventional “three-batch” mode, it presupposes that the fixed time is optimal for addressing the raw material variability encountered in routine production. This source of variability is often underestimated during product development and during demonstration of “process validation” under very controlled conditions (e.g., use of the same lot of raw materials, etc.). Manufacturing difficulties and out of specification results, with no clear root cause, for “validated” processes increases production cycle time, results in rejection or recalls, and erodes regulatory and public confidence.

Sahni et al. (9) have described a general framework for utilizing an appropriate experimental design to identify critical process parameters and using multivariate techniques for data analysis. Specifically, the authors investigated two material streams and five different process variables. Using a full factorial design to probe the effects of these variables and their interaction(s) would require  $2^7$ , or 128, experiments. In order to take a more efficient, yet structured approach, a fractional factorial design (using 32 experiments) was employed to identify critical material and process attributes.

Because the system described above is multifactorial, a simple univariate approach to data analysis would likely not elicit the critical factors. In that regard,

principal component analysis (PCA) and partial least squares (PLS) regression, typical multivariate analysis techniques, were used for analyzing data from the 32 experiments. Several sources are available for in-depth understanding of these techniques (10,11).

Briefly, PCA models the data in terms of the significant factors, or “principal components,” which describe the systematic variability of the data. PCA also describes the data in terms of “residuals” that represent the noise in the system. PLS may be described as a method for constructing predictive models from data sets with many collinear factors. Both have received considerable attention in the analysis of multivariate data.

A group of investigators from the Netherlands employed similar multivariate techniques for modeling the manufacture of tablets, using wet granulation for optimization and in-process control (12). Again, material and process attributes were investigated using a systematic approach to identify the critical process parameters/material attributes having a significant effect on tablet quality. Once identified, the authors developed a strategy for in-process control of the critical variables, such that tablet quality could be ensured and predicted via the developed models, throughout the production process. Consequently, a test of the final product/tablet would confirm the prediction of product quality, thereby validating both the process control strategy and the model.

In order to adequately evaluate these complex systems, multivariate data analysis techniques must be used. The examples previously discussed highlight only a few approaches to multivariate data acquisition and analysis. There are many approaches for using these tools to obtain an increased understanding of granulation, and to elicit critical process/material attributes, as well as their relationship with final product quality attributes, for controlling the manufacturing process.

## 4.2. Process Analyzers

In terms of innovation, some of the most significant advances have occurred in the area of process analyzers, and there are numerous examples of the application of these tools to obtain a greater understanding of the granulation process. Certainly, once critical process and material attributes have been identified, an appropriate tool for the analysis of these attributes is crucial for timely analysis, as well as ultimately controlling the granulation process.

Many studies have detailed the use of various devices for monitoring granulation process conditions, including drive shaft torque (13) and power consumption of the motor (14) for high-shear granulation processes. Although other investigations have demonstrated the relationship between these measurements and granule growth (15), they are indirect measures of in-process material quality. As such, any change in the process or material (including raw material) would affect these measurements. Consequently, a measurement of the process parameter would not accurately represent the true value of the quality attribute of interest.

Spectroscopic sensors, most notably near infrared (NIR), have received significant attention in the analysis and control of the granulation process. Rantanen et al. have published several examples on the use of NIR for in-line measurement of moisture and particle size during fluid-bed granulation (16,17), as well as automation of the granulation process (18). Using sensors in this manner provides insight into the process, allowing the direct measurement and nondestructive analysis of “samples” in the product stream.

These sensors have also been used to elicit physical information about the granules, such as particle size, to understand (and subsequently control) the impact of other material attributes and process parameters on product quality. For example, Watano et al. developed a system for monitoring granule growth via an imaging system, which employed, among other items, a CCD camera (19) and an image probe inserted into a high-shear granulator. The system was used not only for monitoring granule growth, but also for control of the high-shear granulation process.

### 4.3. Process Control Tools

Currently, the end point of most granulation processes are based on measurements of time (i.e., add binder for  $t_1$  min, mass for  $t_2$  min, etc.) or process parameters (such as power or torque as described earlier). However, a direct measure of the critical/desired product quality attribute (particle size, density, moisture, etc.) would be ideal for its control. Subsequent determination of granulation end point would therefore be based on a direct measure of the desired quality attribute, rather than it being inferred from process parameters, and later confirmed through laboratory measurements.

Materials entering the granulation process are widely known to vary, especially in their physical attributes. The granulation process should therefore manage this variability, and consequently mitigate its risk to product quality by an integrated approach to process control. Additionally, it is important to note that the functionality of incoming material must be measured and understood. This information should ideally be “fed forward” to adjust/control the following unit operations to ensure optimal processing and end-point establishment, such that starting variability is minimized and not transferred to the final product. Limits are often necessary on incoming materials to ensure their variability does not exceed the design space used for developing a given control strategy, lending data from the sensors open to erroneous interpretation/analysis and thus introducing a failure risk to the control strategy. However, such excursions from the design space, if and when they occur, can provide an opportunity for its expansion, as well as expand the general knowledge base of the process.

Many examples of controlling the granulation process can be found in the literature. Following development of the on-line imaging system for monitoring granule growth, Watano et al. incorporated a fuzzy control system for granule growth (20). Granule growth was measured via the imaging system and fed into the fuzzy control system. Based on measurements of granule size, the fuzzy control system adjusts various process parameters in order to obtain the desired particle size distribution.

Several other investigations have also focused on the use of NIR for moisture analysis and control during granulation, including Frake et al. (21). In their study, the investigators employed the use of an NIR sensor for real-time determination of the moisture content and particle size distribution of a fluid-bed granulation. This control strategy permits any necessary modifications to process conditions, as well as the identification of a process end point, once the desired moisture content and particle size are obtained.

Although a few examples of traditional “feed-back” control for granulation processes were described, the concept of “feed-forward” control has been investigated as well. Paul Mort et al. discuss the aspects of feed-forward control associated with a continuous granulation process (22). Based on the amount of recycled fines reintroduced into the system, and attributes of the incoming materials, the binder solution is modified to obtain the desired granule density and particle size.

Appropriate strategies for process control provide an assurance, with every product manufactured, that the desired product quality will be obtained. A test of the final product thereby “validates” that the process is indeed under control.

#### 4.4. Continuous Improvement and Knowledge Management Tools

Continuous learning of the production process also allows for optimization of process parameters that may not have been fully explored during development. Additionally, any changes to a given process, granulation or otherwise, could be considered low-risk because of the level of process understanding achieved and demonstrated, thereby reducing the regulatory burden to change control/management. Ultimately, an inverse relationship exists between the level of process understanding and the risk of producing a poor-quality product. Thus, a focus on process understanding can facilitate risk-based regulatory decisions and innovation (1).

Continuous learning through data collection and analysis over the life cycle of a product is crucial. However, information gleaned from the production process of one product should not be considered in isolation. Management and generalization of knowledge from one product to another can allow for the development of expert systems and a large knowledge base that can be used to facilitate future process development, scale-up, optimization, etc.

For example, expert systems such as neural networks can be employed to model various stages of the production process, including granulation. Investigators in Finland have noted the advantages of such systems in modeling the fluid-bed granulation process (23). Results from this investigation demonstrated that the networks were able to more accurately predict responses to the granulation process than multilinear stepwise regression analysis.

## 5. CONCLUSION

Implementing the PAT framework and having a greater understanding of the manufacturing process has obvious advantages to the pharmaceutical industry, the regulators, and the public health. The PAT Initiative provides a regulatory environment that encourages and facilitates pharmaceutical companies to innovate and employ the tools necessary to achieve an in-depth understanding of the manufacturing process. There are many examples in the literature that suggest that active control of the granulation is not only possible, but may soon become the rule, rather than the exception. This paper was written prior to the FDA's final report on CGMPs for the 21st century. The readers are requested to review this report ([http://www.fda.gov/cder/gmp/gmp2004/GMP\\_finalreport2004.htm](http://www.fda.gov/cder/gmp/gmp2004/GMP_finalreport2004.htm)), in particular the FDA's White Paper entitled “Innovation and Continuous Improvement in Pharmaceutical Manufacturing” available at <http://www.fda.gov/cder/gmp/gmp2004/manufSciWP.pdf>.

## REFERENCES

1. Guidance for Industry: PAT—A Framework for Innovative Pharmaceutical Development, Manufacturing, and Quality Assurance. September 2004. <http://www.fda.gov/cder/guidance/6419fnl.htm>.
2. Aguayo R. Dr. Deming: the American who taught the Japanese about quality. Fireside 1991; September 15.

3. Juran JM. Juran on quality by design: the new steps for planning quality into goods and services. Free Press 1992; May 4, revised edition.
4. Advisory Committee for Pharmaceutical Science. Transcript of Meeting, July 2001. <http://www.fda.gov/ohrms/dockets/ac/01/transcripts/3763t1.htm>.
5. Science Board to the Food and Drug Administration. Transcript of Meeting, November 2001. <http://www.fda.gov/ohrms/dockets/ac/01/transcripts/3799t1.htm>.
6. Science Board to the Food and Drug Administration. Transcript of Meeting, April 2003. <http://www.fda.gov/ohrms/dockets/ac/03/transcripts/3944t1.DOC>.
7. Food and Drug Administration. Unveils New Initiative to Enhance Pharmaceutical Good Manufacturing Practices, August 21, 2002. <http://www.fda.gov/bbs/topics/NEWS/2002/NEW00829.html>.
8. Food and Drug Administration. Announces New Progress toward "21st Century" Regulation of Pharmaceutical Manufacturing, September 3, 2003. <http://www.fda.gov/cder/gmp/index.htm>.
9. Sahni NS, Isaksson T, Tormod Naes. The use of experimental design methodology and multivariate analysis to determine critical control points in a process. *Chemometrics Intelligent Lab Syst* 2001; 56:105–121.
10. Brereton RG. *Multivariate Signal Processing in Chemometrics. Application of Mathematics and Statistics to Laboratory Systems*. Chichester, U.K.: Ellis Horwood, 1990:209–237.
11. Wold S, Albano C, Dunn WJ, Edlund U, Esbensen K, Geladi P, Hellberg S, Johansson E, Lindsberg W, Sjostrom M. *Multivariate Data Analysis in Chemistry. Chemometrics: Mathematics and Statistics in Chemistry*. Reidel Dordrecht, The Netherlands 1984:17–95.
12. Westerhuis JA, Coenegracht PMJ, Lerk CF. Multivariate modeling of the tablet manufacturing process with wet granulation for tablet optimization and in-process control. *Int J Pharm* 1997; 156:109–117.
13. Lindberg NO, Leander LL, Reenstierna B. Instrumentation of a Kenwood Major domestic type mixer for studies of granulation. *Drug Dev Ind Pharm* 1982; 8:775–782.
14. Leuenberger H. Scale-up of granulation processes with reference to power consumption monitoring. *Pharm Acta Helv* 1983; 29:274–280.
15. Holm P, Schaefer T, Kristensen HG. Granulation in high-speed mixers. Part V: Power consumption and temperature changes during granulation. *Powder Technol* 1985; 43:213–223.
16. Rantanen J, Rasanen E, Tenhunen J, Kansakoski M, Mannermaa J, Yliruusi J. In-line moisture measurement during granulation with a four-wavelength near infrared sensor: an evaluation of particle size and binder effects. *Eur J Pharm Biopharm* 2000; 50:271–276.
17. Rantanen J, Jorgensen A, Rasanen E, Luukkonen P, Airaksinen S, Raiman J, Hanninen K, Antikainen O, Yliruusi J. Process analysis of fluidized bed granulation. *AAPS PharmSciTech* 2001; 2(4):21.
18. Rantanen J, Kansakoski M, Suhonen J, Tenhunen J, Lehtonen S, Rajalahti T, Mannermaa JP, Yliruusi J. Next generation fluidized bed granulator automation. *AAPS PharmSciTech* 2000; 1(2):10.
19. Watano S, Numa T, Koizumi I, Osaka Y. Feedback control in high shear granulation of pharmaceutical powders. *Eur J Pharm Biopharm* 2001; 52:337–345.
20. Watano S, Numa T, Miyayami K, Osaka Y. A fuzzy control system of a high shear granulation using image processing. *Powder Technol* 2001; 115:124–130.
21. Frake P, Greenhalgh D, Grierson SM, Hempenstall JM, Rudd DR. Process control and end-point determination of a fluid bed granulation by application of near infrared spectroscopy. *Int J Pharm* 1997; 151:75–80.
22. Mort PR, Capecci SW, Holder JW. Control of agglomerate attributes in a continuous binder-agglomeration process. *Powder Technol* 2001; 117:173–176.
23. Murtoniemi E, Yliruusi J, Kinnunen P, Merkke P, Leiviska K. The advantages by the use of neural networks in modeling the fluidized bed granulation process. *Int J Pharm* 1994; 108(2):155–164.

# 21

## Granulation Process Modeling

**I. T. Cameron and F. Y. Wang**

*Particle and Systems Design Centre, School of Engineering,  
The University of Queensland, Queensland, Australia*

### 1. MODELING OF GRANULATION SYSTEMS

In this section, we introduce the background to granulation modeling by posing the question, “Why model?” and a further one, “How are models used in granulation systems technology?” The following sections seek to answer these questions and demonstrate the benefits that can be derived from appropriate granulation process modeling.

#### 1.1. Motivation for Modeling

There are many motivations for modeling granulation systems that are common to all process-related modeling. This is an area, that has grown enormously over the last 50 years. Michaels (32) has pointed out that despite the change of particle technology from an underfunded and widely scattered research enterprise to a thriving globally recognized engineering discipline over the past 25 years, design and analysis of industrial particulate processes remain rooted in empiricism. Without exception, granulation processes, like most solid-handling operations, continue to be one of the least understood and hence inefficient in the process industries. Thus, granulation remained more of “an art than a science” until a decade ago, as stated by Litster (24). Granulation operations were performed by employing popular practice rather than through systematic scientifically-based strategies. The ineffectiveness of this approach led researchers on a quest to represent the dynamic or steady-state characteristics of systems through a deeper understanding of the relevant phenomena of the physico-chemical phenomena being studied. Likewise in granulation systems, there has been a growing interest in the building of models and their deployment to address a range of applications.

##### 1.1.1. Benefits

The benefits from the use of modeling include:

- An increased understanding of the governing mechanisms through endeavoring to represent them in the model description.

- An increased understanding of the relative importance of mechanistic contributions to the outputs of the process.
- Capturing of insight and knowledge in a mathematically usable form.
- Documentation of research findings in accessible form for various applications.
- Application of models for improved control performance and process diagnosis.
- Potential reuse of model components for a variety of applications from design through to process diagnosis.
- As a vehicle for new, novel designs of processing equipment.
- As a means to direct further experimentation and process data generation.

### 1.1.2. Costs

There are several important and not insubstantial costs involved in process modeling including:

- Time to plan, develop, test, and deploy models.
- Personnel with the requisite discipline background to generate effective models through insight and modeling skills.
- The effort in laboratory-scale or plant scale-trials to elucidate process behavior and the cost of doing so.
- The cost of poor modeling practice in terms of inadequate documentation through the modeling phases and loss of corporate memory.

## 1.2. Process Modeling Fundamentals

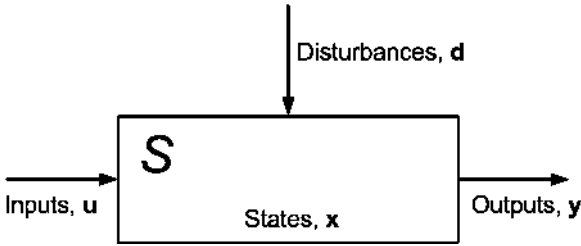
Process modeling is purpose driven in that a model is developed for a particular area. These areas could include:

- Improved control performance through the use of process model-based control algorithms.
- Optimal performance of granulation systems through model-based optimization of production parameters such as shortest batch time or optimal product size distribution.
- Improved production scheduling using models to generate improved batch times estimates.
- Plant diagnosis for real-time plant operator guidance systems (OGS).
- Extraction of parameter estimates such as rate constants and granulation kernel parameters.
- Improved design of equipment or development of new designs based on better understanding and use of mechanistic phenomena.

The resultant model must be “fit-for-purpose,” and this is achieved by having clearly stated goals for the modeling that are used to help assess the appropriateness of the model form and the model fidelity required for the job. In particular, modeling requires a methodology, especially one that is generic in nature.

### 1.2.1. A Systems Perspective

Models need to be built on a clear systems engineering understanding of the process. A typical system schematic is seen in [Figure 1](#). For the system ( $S$ ), we need to clearly define the inputs ( $u$ ), and disturbances ( $d$ ), to our system as well as the outputs ( $y$ )



**Figure 1** Schematic of a process system.

and the states of interest ( $\mathbf{x}$ ). The system  $\mathbf{S}$  converts inputs and disturbances to outputs and is expressed as:

$$\mathbf{y} = \mathbf{S}[\mathbf{u}, \mathbf{d}] \quad (1.1)$$

A model  $\mathbf{M}$  is a representation of the system that transforms inputs to predicted outputs  $\mathbf{y}^{(\mathbf{M})}$  in the form:

$$\mathbf{y}^{(\mathbf{M})} = \mathbf{M}[\mathbf{u}, \mathbf{d}] \quad (1.2)$$

How close  $\mathbf{y}$  and  $\mathbf{y}^{(\mathbf{M})}$  are is a key question in model validation.

Approaching modeling from a systems perspective provides a clear framework for developing models and identifying the key issues to be considered. Four principal classes of variables play particular roles in the modeling. They are:

*Inputs:*

Inputs  $\mathbf{u}$  are the variables that are manipulated to “drive” the system or maintain its condition in the face of changes from disturbances. Typically, we consider such aspects as binder addition rate or mixing intensity as inputs that we can manipulate.

*Disturbances:*

Disturbances  $\mathbf{d}$  are variables over which we do not have clear control. They arise from raw material properties that might change from batch to batch. They could be environmental factors such as ambient temperature and humidity. They might be fluctuations in input voltage to motors or steam pressure that produce temperature disturbances in heated systems. Principal disturbances in all relevant categories need to be identified.

*Outputs:*

Outputs  $\mathbf{y}$  are the variables of interest for the designer, operator, or manager. They might be quality variables that are related to granule properties such as size distribution, granule moisture, or granule hardness. Other outputs of interest could be related to product temperature, flowrates, and composition. The outputs are necessarily measurable in some way, either directly on-line such as PSD or moisture, or via laboratory analysis such as composition.

*States:*

States  $\mathbf{x}$  of the system represent the internal variables that characterize the system behavior at any point in time.

Finally the system  $\mathbf{S}$  is a major consideration in modeling because of the various ways the real system can be represented by the model  $\mathbf{M}$  of that system. Numerous forms of the model  $\mathbf{M}$  are available. They can have a structure based on capturing fundamental phenomena from physics and chemistry (“white box”



models) to internal structures based on purely empirical approaches known as “black box” models. For black box models, the form is simply a convenient equation that captures the relationships amongst inputs, disturbances, and outputs.

1.2.2. Modeling Methodology and Workflow

Modeling should not be a haphazard activity. It is essential that a consistent and defensible methodology be adopted. One such methodology is given by Hangos & Cameron (2001) and is seen in Figure 2. Each of the seven key steps is a vital part of any modeling activity, emphasizing that modern process modeling is not just

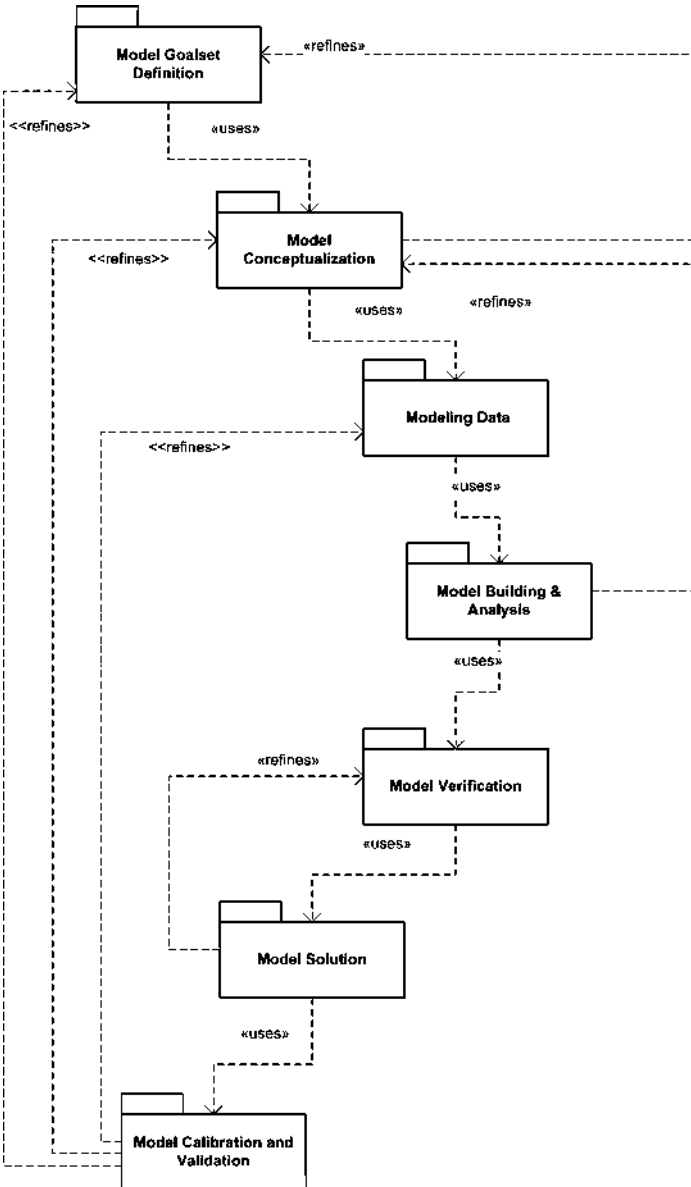


Figure 2 Modeling methodology and workflow.

about generating a set of equations. It is a much more holistic activity. It is also iterative in nature as seen in [Figure 2](#).

The key aspects can be summarized as:

- *Goal-set definition*: making clear the reason for the modeling and the goals to be addressed in the modeling.
- *Model conceptualization*: clarifying the conserved quantities and the governing mechanisms to be included. Clearly setting out the assumptions underlying the model.
- *Modeling data*: generating or referencing physical property data or plant data relevant to model building and model validation.
- *Model building and analysis*: putting the model together and then analyzing the model for properties relevant to solution and dynamic properties.
- *Model verification*: ensuring that the coded model in the simulation environment is correctly represented and bug-free.
- *Model solution*: solving the model numerically or analytically in some limited circumstances. This can be a challenging task.
- *Model calibration and validation*: performing parameter estimation and then validating the model against plant or laboratory data.

### 1.2.3. The Modeling Goal

The modeling goal plays a vital role in the development of the model. Here we consider the most important general goals and describe briefly what is achieved. We make reference to the general process system illustrated in [Figure 1](#).

#### Dynamic simulation problem

The model is developed to predict the system behavior in time. We wish to predict the outputs  $\mathbf{y}$ , given the inputs  $\mathbf{u}$ , the disturbance pattern  $\mathbf{d}$ , the model structure  $\mathbf{M}$  with the model parameters  $\mathbf{p}$ . This is the most common goal.

#### Design problem

We are interested in calculating certain parameters or design from the parameter set given all the other inputs, model form, disturbances, and a set of desired outputs.

#### Process control

##### *Regulation and state-driving problems*

We aim at designing or computing the inputs  $\mathbf{u}$  for a prescribed response  $\mathbf{y}$  of the system.

##### *System identification problem*

We seek to determine the structure of the model  $\mathbf{M}$  and its parameters  $\mathbf{p}$ , using input and output information.

##### *State estimation problem*

We attempt to estimate the internal states  $\mathbf{x}$  of a particular model  $\mathbf{M}$ .

##### *Fault detection and diagnosis problem*

We bring to light the faulty modes and/or system parameters which correspond to the *measured* input and output data.

These three key areas show the various goals that are often given for modeling of processing systems.

## 1.3. Approaches to Modeling

There are several approaches to modeling process systems. At one extreme, we have mechanistic modeling that seeks to incorporate fundamental physics and chemistry

into the model. This is the so-called “white box” approach. At the other end of the spectrum, we have the fitting of an arbitrary function to the input–output data—the empirical model. In between, we have the so-called “gray box” models that are normally what is developed. Some relevant comments follow.

### 1.3.1. Empirical or Black Box Methods

These models are based on actual plant data, typically in the form of time series of input and output data at fixed time intervals. The model is built by selecting a model structure  $M$  and then fitting the model parameters to get the best fit of the model to the data. Model forms such as auto-regressive moving average (ARMA) or auto-regressive moving average exogenous (ARMAX) are typically used.

In most cases, techniques are used to vary both the structure and the model parameters to obtain the “best” or simplest model that gives the “best” fit. Various information criteria like Akaike’s or Bayesian measures can be used that essentially get the simplest model for the best fit. It is a form of parsimony in model building. Many packages such as the MATLAB<sup>TM</sup> Identification Toolbox help in such modeling.

This approach can be very useful if no significant insight is needed into the model, but when a model is needed quickly to be used for a control application. The structural form of the model and the parameter values normally have no physical significance. The application range of such a model is limited to the range of data, and hence this can be a significant limitation. Extrapolation is dangerous.

### 1.3.2. Mechanistic and Gray-Box Models

Mechanistic models incorporate the underlying understanding of physics and chemistry into the models. Typically, we can identify three major aspects in mechanistic modeling that cover conservation and constitutive aspects:

- Application of thermodynamic conservation principles for mass, energy, and momentum and,
- Application of population balances that track particle size distributions as various particulate phenomena take place.
- Development of appropriate constitutive relations that define intensive properties, mass and heat transfer mechanisms, as well as particle growth and breakage mechanisms.

The development of mechanistic models is far more complex and time-consuming than it is for empirical models and is only justified when time permits. The model is to be used over a wide operating range and the relevant insight in establishing the constitutive relations is available.

Inevitably, even the best mechanistic models require some data fitting, leading to the concept of “gray box” models. This is the normal practice in industrial modeling of such systems. It means that adequate data must be available to carry out the validation studies. This task is particularly difficult for the validation of dynamic models.

## 2. KEY FACTORS IN GRANULATION MODELING

The modeling of granulation system from a mechanistic perspective inevitably means representing the conservation principles and the constitutive relations that reflect the

key factors in granulation. We briefly consider these in turn but refer the reader to the relevant chapters in this handbook for detailed descriptions of the phenomena.

## 2.1. Conservation Principles

The conservation of mass, energy, momentum, and particle number can be important aspects of granulation modeling.

Mass conservation is crucial and is the fundamental concept for any granulation system. Key factors here will be solids or slurry feed rates, any out flows, and the addition of binders and additives to the granulation device. Accompanying the mass balance over the device will be the energy balance, from which the intensive property of temperature can be estimated.

Of particular importance in granulation systems is the factor of particle populations. The particle size distribution within granulation devices is crucial, and there are a number of mechanisms that simultaneously occur in the device depending on the powder properties and operating regime. The challenge is in the description of these mechanisms that occur. The following section outlines those mechanisms that require consideration. Section 3 deals in detail with the development of population balance representations and their variants.

## 2.2. Principal Constitutive Mechanisms

There are three principal mechanisms that need to be considered.

### 2.2.1. Nucleation

Nucleation refers to the formation of initial aggregates that are typically a result of the interaction between the binder spray droplets and the powder in the device. This mechanism provides the initial stage for further growth through a number of mechanisms. A number of nucleation models have been proposed in the literature.

### 2.2.2. Growth

Granule growth occurs through two key mechanisms that can be distinguished for discussion purposes. The topic is discussed more fully in “One-Dimensional Population Balance Models”.

**2.2.2.1. Layering.** Layering refers to the taking up of fine particles onto the surface of larger granules. It is often induced by rolling action and is a means of granule growth that creates hard, compact granules. A practical layering model is proposed in “Optimization and Open-Loop Optimal Control Equations” for solving optimal control of granulation processes.

**2.2.2.2. Agglomeration.** Agglomeration or coalescence refers to the successful collision of two particles that result in a composite particle. The success of collisions can be a function of particle size, binder and powder properties, and operational factors such as bed height, powder velocity, and shear for mixer granulators. See “[Coalescence Kernels](#)” for more details.

### 2.2.3. Breakage

Breakage in high shear and drum granulation is a significant issue, and is especially more important in high-shear devices. There are various forms of breakage from cleavage of particles to particle surface attrition where granule is chipped by collision with other particles, wall, or impeller. Complexity of breakage models extends from

binary breakage models to full particle distributions represented by breakage and selection functions, or empirical models (38,45,54).

The following sections develop in detail some of the important aspects of granulation process modeling, through the use of population balances and alternative approaches.

### 3. REPRESENTING GRANULATION PROCESSES THROUGH POPULATION BALANCES

The particulate nature of solids is characterized by a number of properties, such as size, shape, liquid and gas content, porosity, composition, and age. These are denoted as internal coordinates, whereas Euclidian coordinates, such as rectangular coordinates  $(x, y, z)$ , cylindrical coordinates  $(r, \phi, z)$ , and spherical coordinates  $(r, \theta, \phi)$  used to specify the locations of particles, are defined as external coordinates.

The most important property for the characterization of particles is particle size. Randolph and Larson (36) pointed out that: “As no two particles will be exactly the same size, the material must be characterized by the distribution of sizes or particle-size distribution (PSD).” If only size is of interest, a single-variable distribution function is sufficient to characterize the particulate system. If additional properties are also important, multivariable distribution functions must be developed. These distribution functions can be predicted through numerical simulations using population balance equations (PBE).

Ramkrishna (35) provided a brief explanation on the population balance equation: “The population balance equation is an equation in the foregoing number density and may be regarded as representing a number balance on particles of a particular state. The equation is often coupled with conservation equation for entities in the particles’ environmental (or continuous) phase.”

In this chapter, both single-variable and multivariable population balances are described. However, emphasis will be placed on the single-variable population balance equations with size as the only internal coordinate.

#### 3.1. General Population Balance Equations

A population balance for particles in some fixed subregion of particle phase space can be conceptually represented as follows:

$$\begin{aligned}
 \left\{ \begin{array}{l} \text{density function change} \\ \text{in class, location \& time} \end{array} \right\} &= \left\{ \begin{array}{l} \text{disperse in} \\ \text{through boundary} \end{array} \right\} - \left\{ \begin{array}{l} \text{disperse out} \\ \text{through boundary} \end{array} \right\} \\
 &+ \left\{ \begin{array}{l} \text{flow in} \\ \text{through boundary} \end{array} \right\} - \left\{ \begin{array}{l} \text{flow out} \\ \text{through boundary} \end{array} \right\} \\
 &+ \left\{ \begin{array}{l} \text{grow in} \\ \text{from lower classes} \end{array} \right\} - \left\{ \begin{array}{l} \text{grow out} \\ \text{from current class} \end{array} \right\} \\
 &+ \left\{ \begin{array}{l} \text{birth due to} \\ \text{coalescence} \end{array} \right\} - \left\{ \begin{array}{l} \text{death due to} \\ \text{coalescence} \end{array} \right\} \\
 &+ \left\{ \begin{array}{l} \text{break-up in} \\ \text{from upper classes} \end{array} \right\} - \left\{ \begin{array}{l} \text{breakup out} \\ \text{from current class} \end{array} \right\}
 \end{aligned}
 \tag{3.1}$$

The superstructure of the general population balance equation can be represented as follows:

$$\frac{\partial}{\partial t} f(\mathbf{x}, \mathbf{r}, t) = \nabla_{\mathbf{r}} \bullet \mathbf{r} m \nabla_{\mathbf{r}} [D_{\mathbf{r}} f(\mathbf{x}, \mathbf{r}, t)] - \nabla_{\mathbf{r}} \bullet \dot{\mathbf{R}} f(\mathbf{x}, \mathbf{r}, t) - \nabla_{\mathbf{x}} \bullet \dot{\mathbf{X}} f(\mathbf{x}, \mathbf{r}, t) \quad (3.2)$$

$$+ B_c(\mathbf{x}, \mathbf{r}, t) - D_c(\mathbf{x}, \mathbf{r}, t) + B_b(\mathbf{x}, \mathbf{r}, t) - D_b(\mathbf{x}, \mathbf{r}, t)$$

where  $f$  is the multivariant number density as a function of properties and locations;  $\mathbf{r}$  is the external coordinate vector (also known as spatial coordinate vector) for the determination of particle locations;  $\mathbf{x}$  is the internal coordinate vector for the identification of particle properties, such as size, moisture content, and age;  $D_{\mathbf{r}}$  is the dispersion coefficient;  $\dot{\mathbf{R}}$  is the velocity vector in the external coordinate system;  $\dot{\mathbf{X}}$  is the rate vector in the internal coordinate system;  $B_c$  and  $D_c$  are birth and death rates for coalescence, respectively;  $B_b$  and  $D_b$  are birth and death rates for breakage, respectively. The first and second terms in the right-hand side of Eq. 3.2 represent dispersion and convection particle transport, respectively, whereas the third quantifies the growth of particles with respect to various properties, such as size and moisture. The birth and death rates for coalescence are given by:

$$B_c(\mathbf{x}, \mathbf{r}, t) = \int_{\Omega_{\mathbf{x}}} dV_{\mathbf{x}'} \int_{\Omega_{\mathbf{r}}} \frac{1}{\delta} \beta(\tilde{\mathbf{x}}, \tilde{\mathbf{r}}; \mathbf{x}', \mathbf{r}') f(\mathbf{x}, \mathbf{r}, t) f(\mathbf{x}', \mathbf{r}', t) \frac{\partial(\tilde{\mathbf{x}}, \tilde{\mathbf{r}})}{\partial(\mathbf{x}, \mathbf{r})} dV_{\mathbf{r}'} \quad (3.3)$$

$$D_c(\mathbf{x}, \mathbf{r}, t) = f(\mathbf{x}, \mathbf{r}, t) \int_{\Omega_{\mathbf{x}}} dV_{\mathbf{x}'} \int_{\Omega_{\mathbf{r}}} \beta(\mathbf{x}', \mathbf{r}'; \mathbf{x}, \mathbf{r}) \mathbf{f}(\mathbf{x}', \mathbf{r}', t) dV_{\mathbf{r}'}$$

where  $\beta$  is the coalescence kernel,  $\Omega_{\mathbf{x}}$  and  $\Omega_{\mathbf{r}}$  are integration boundaries for internal and external coordinates, respectively,  $\delta$  represents the number of times identical pairs have been considered in the interval of integration so that  $1/\delta$  corrects for the redundancy, the term  $\frac{\partial(\tilde{\mathbf{x}}, \tilde{\mathbf{r}})}{\partial(\mathbf{x}, \mathbf{r})}$  stands for the coordinate transformation such that the colliding pair with original coordinates  $[\tilde{\mathbf{x}}, \tilde{\mathbf{r}}]$  and  $[\mathbf{x}', \mathbf{r}']$ , respectively, before collision should be identified by the coordinates  $[\mathbf{x}, \mathbf{r}]$  after coalescence. Mathematically, this requires that the density with respect to coordinates  $[\tilde{\mathbf{x}}(\mathbf{x}, \mathbf{r}|\mathbf{x}'\mathbf{r}'), \tilde{\mathbf{r}}(\mathbf{x}, \mathbf{r}|\mathbf{x}'\mathbf{r}')]$  must be transformed into one in terms of  $(\mathbf{x}, \mathbf{r})$  by using the appropriate Jacobian of the transformation. Ramkrishna (35) showed that the determinant of the Jacobian of the transformation satisfies the following equation:

$$\frac{\partial(\tilde{\mathbf{x}}, \tilde{\mathbf{r}})}{\partial(\mathbf{x}, \mathbf{r})} = \begin{vmatrix} \frac{\partial \tilde{x}_1}{\partial x_1} & \dots & \frac{\partial \tilde{x}_1}{\partial x_n} & \frac{\partial \tilde{x}_1}{\partial r_1} & \frac{\partial \tilde{x}_1}{\partial r_2} & \frac{\partial \tilde{x}_1}{\partial r_3} \\ \vdots & \vdots & \vdots & \vdots & \vdots & \vdots \\ \frac{\partial \tilde{x}_n}{\partial x_1} & \dots & \frac{\partial \tilde{x}_n}{\partial x_n} & \frac{\partial \tilde{x}_n}{\partial r_1} & \frac{\partial \tilde{x}_n}{\partial r_2} & \frac{\partial \tilde{x}_n}{\partial r_3} \\ \frac{\partial \tilde{r}_1}{\partial x_1} & \dots & \frac{\partial \tilde{r}_1}{\partial x_n} & \frac{\partial \tilde{r}_1}{\partial r_1} & \frac{\partial \tilde{r}_1}{\partial r_2} & \frac{\partial \tilde{r}_1}{\partial r_3} \\ \frac{\partial \tilde{r}_2}{\partial x_1} & \dots & \frac{\partial \tilde{r}_2}{\partial x_n} & \frac{\partial \tilde{r}_2}{\partial r_1} & \frac{\partial \tilde{r}_2}{\partial r_2} & \frac{\partial \tilde{r}_2}{\partial r_3} \\ \frac{\partial \tilde{r}_3}{\partial x_1} & \dots & \frac{\partial \tilde{r}_3}{\partial x_n} & \frac{\partial \tilde{r}_3}{\partial r_1} & \frac{\partial \tilde{r}_3}{\partial r_2} & \frac{\partial \tilde{r}_3}{\partial r_3} \end{vmatrix} \quad (3.4)$$

The birth and death rates for breakage are described as:

$$B_b(\mathbf{x}, \mathbf{r}, t) = \int_{\Omega_{\mathbf{r}}} dV_{\mathbf{r}'} \int_{\Omega_{\mathbf{x}}} b(\mathbf{x}', \mathbf{r}', t) P(\mathbf{x}, \mathbf{r} | \mathbf{x}', \mathbf{r}', t) S(\mathbf{x}', \mathbf{r}', t) f(\mathbf{x}', \mathbf{r}', t) dV_{\mathbf{x}'} \quad (3.5)$$

$$D_b(\mathbf{x}, \mathbf{r}, t) = S(\mathbf{x}, \mathbf{r}, t) f(\mathbf{x}, \mathbf{r}, t) \quad (3.6)$$

where  $b(\mathbf{x}', \mathbf{r}', t)$  is the average number of particles formed from the breakage of a single particle of state  $(\mathbf{x}', \mathbf{r}')$  at time  $t$ ,  $P(\mathbf{x}, \mathbf{r} | \mathbf{x}', \mathbf{r}', t)$  is the probability density function for particle from the breakage of state  $(\mathbf{x}', \mathbf{r}')$  at time  $t$  that have state  $(\mathbf{x}, \mathbf{r})$ ,  $S(\mathbf{x}, \mathbf{r}, t)$  is the selection function, which represents the fraction of particles of state  $(\mathbf{x}, \mathbf{r})$  breaking per unit time.

Equations 3.3 and 3.4 and involve three different locations: and  $\tilde{\mathbf{r}}$  and  $\mathbf{r}'$  for the colliding pair of particles and  $\mathbf{r}$  for the agglomerated particle. Although this treatment is general and mathematically rigorous, it could be unnecessarily complicated for engineering applications. A common practice is to assume that these three locations are very close to each other during the particle collision and granule formation. That is:

$$\tilde{\mathbf{r}} \approx \mathbf{r}' \approx \mathbf{r} \quad (3.7)$$

This assumption requires that the phenomenon of fast particle jumps in the system is not severe, which is achievable in most industrial granulation processes. If Eq. 3.7 holds, Eq. 3.3 and 3.4 can be simplified considerably to obtain:

$$B_c(\mathbf{x}, \mathbf{r}, t) = \frac{1}{2} \int_{\Omega_{\mathbf{x}}} \beta(\tilde{\mathbf{x}}, \mathbf{x}', \mathbf{r}) f(\tilde{\mathbf{x}}, \mathbf{r}, t) f(\mathbf{x}', \mathbf{r}, t) \frac{\partial(\tilde{\mathbf{x}})}{\partial(\mathbf{x})} dV_{\mathbf{x}'} \quad (3.8)$$

$$D_c(\mathbf{x}, \mathbf{r}, t) = f(\mathbf{x}, \mathbf{r}, t) \int_{\Omega_{\mathbf{x}}} \beta(\mathbf{x}', \mathbf{x}, \mathbf{r}) f(\mathbf{x}', t) dV_{\mathbf{x}'}$$

$$\frac{\partial(\tilde{\mathbf{x}})}{\partial(\mathbf{x})} = \begin{vmatrix} \frac{\partial \tilde{x}_1}{\partial x_1} & \dots & \frac{\partial \tilde{x}_1}{\partial x_n} \\ \vdots & \vdots & \vdots \\ \frac{\partial \tilde{x}_n}{\partial x_1} & \dots & \frac{\partial \tilde{x}_n}{\partial x_n} \end{vmatrix} \quad (3.9)$$

Similarly, Eq. 3.5 becomes:

$$B_b(\mathbf{x}, \mathbf{r}, t) = \int_{\Omega_{\mathbf{x}}} b(\mathbf{x}', \mathbf{r}, t) P(\mathbf{x} | \mathbf{x}', \mathbf{r}, t) S(\mathbf{x}', \mathbf{r}, t) f(\mathbf{x}', \mathbf{r}, t) dV_{\mathbf{x}'} \quad (3.10)$$

In the following, breakage effects have been considered negligible and Eq. 3.7 is always assumed to be valid.

### 3.2. One-Dimensional (1-D) Population Balance Models

One-dimensional population balance models for both batch and continuous systems are described in this section as special cases of the generalized population balance model stated in “General Population Balance Equations.”

#### 3.2.1. Batch Systems

For a well-mixed batch system with only one internal coordinate  $v$  (particle size), is Eq. 3.2 reduced to:

$$\begin{aligned} \frac{\partial}{\partial t} n(v, t) = & -\frac{\partial}{\partial v} [Gn(v, t)] \\ & + \frac{1}{2} \int_0^v \beta(v-v', v') n(v-v', t) n(v', t) dv' - n(v, t) \\ & \times \int_0^\infty \beta(v, v') n(v', t) dv' \end{aligned} \quad (3.11)$$

where  $n$  is the one-dimensional number density,  $G$  is the growth rate. For notational clarity, we use  $f$  and  $n$  to denote the multidimensional and one-dimensional number density functions, respectively. Both notations bear the same physical significance. Through a comparison of Eq. 3.11 with Eq. 3.2, 3.8, and 3.9, it is easy to observe the following membership relationships:

$$v \in \mathbf{x}, \quad v' \in \mathbf{x}', \quad (v-v') \in \tilde{\mathbf{x}}, \quad G = \frac{dv}{dt} \in \dot{\mathbf{X}}, \quad \frac{\partial(\tilde{\mathbf{x}})}{\partial(\mathbf{x})} = \frac{\partial(v-v')}{\partial v} = 1 \quad (3.12)$$

Equation 3.11 is more frequently applied to industrial granulation processes than its generalized format described in Eq. 3.2.

### 3.2.2. Continuous Systems

The population balance equation for continuous systems with one internal coordinate and one external coordinate is given by:

$$\begin{aligned} \frac{\partial}{\partial t} n(v, z, t) = & -\frac{\partial}{\partial z} [\dot{Z}n(v, z, t)] - \frac{\partial}{\partial v} [Gn(v, z, t)] \\ & + \frac{1}{2} \int_0^v \beta(v-v', v') n(v-v', z, t) n(v', z, t) dv' \\ & - n(v, z, t) \int_0^\infty \beta(v, v') n(v', z, t) dv' \end{aligned} \quad (3.13)$$

where the special velocity is defined as:

$$\dot{Z} = \frac{dz}{dt} \in \dot{\mathbf{R}} \quad (3.14)$$

Although continuous granulation processes are commonly encountered in the fertilizer and mineral processing industries, they are also performed in the pharmaceutical industry as batch processes employing either high-shear mixers or batch fluidized-bed granulators. Consequently, most modeling studies on pharmaceutical granulation have focused on batch processes. However, it is important to obtain complete knowledge of both batch and continuous granulation processes for improved design and operations.

### 3.2.3. Coalescence Kernels

It is easy to see that a coalescence kernel is affected by two major factors: (1) collision probability of the specified pair of particles, and (2) successful coalescence or rebounding after collision. The first mainly depends on the particle sizes, granulator configurations, particle flow patterns, and operating conditions. The second has been intensively studied by Liu et al. (25) who identified the following four most important aspects affecting the success of coalescence: elasticplastic properties, viscous fluid layer, head of collision, and energy balance. The authors have also observed that there are two types of coalescence distinguished by particle deformations. That is,



**Table 1** Summary of the Proposed Coalescence Kernel in the Literature

Kernel	References
$\beta = \beta_0$	(18)
$\beta = \beta_0 \frac{(u+v)^a}{(uv)^b}$	(19)
$\beta = \beta_0 \frac{(u^{2/3} + v^{2/3})}{1/u + 1/v}$	(40)
$\beta = a(u + v)$	(14)
$\beta = a \frac{(u-v)^2}{(u+v)}$	(14)
$\beta = \begin{cases} k, & t < t_s \\ a(u + v), & t > t_s \end{cases}$	(1)
<i>k</i> : constant, <i>t<sub>s</sub></i> : switching time	
$\beta = \begin{cases} k, & w < w^* \\ 0, & w > w^* \end{cases}$	(2)
$w = \frac{(u + v)^a}{(uv)^b}$	
<i>k</i> , <i>a</i> , <i>b</i> : constants <i>w</i> *: critical granule volume	
$\beta = \beta_0(1/u + 1/v)^{1/2} (u^{1/3} + v^{1/3})^2$	(13)
$\beta = \beta_0 (u^{-1/3} + v^{-1/3}) (u^{1/3} + v^{1/3})$	
$\beta _{u,v} = \begin{cases} \beta_1 & \text{Types I \& II without permanent deformation} \\ \beta_2 & \text{Type II with permanent deformation} \\ 0 & \text{rebound} \end{cases}$	Liu and Litster (2001)

Type I coalescence is not associated with any particle deformation during the collision, whereas the Type II is accompanied by particle deformations. Liu and Litster (26) further proposed a new physically based coalescence kernel model based on the criteria developed earlier [Liu et al., (25)]. From these fundamental studies, it can be determined qualitatively that the coalescence kernels should depend on particle sizes, energy consumption, particle deformability, and most importantly, the moisture content (viscous fluid layer). A historical summary of the proposed coalescence kernels is given in Table 1, which is an extension of the table originally presented by Ennis and Litster (11) with the new coalescence kernel developed by Liu and Litster (26) and another kernel from aerosol dynamics [Friedlander, (13)].

### 3.3. Two-Dimensional (2-D) Population Balance Models

In this section, we study a perfect mixing, batch granulation system with two internal (property) coordinates: particle value *v* and liquid value *v<sub>L</sub>*. Because of the perfect

mixing feature, there is no spatial coordinate in the model. However, the proposed modeling strategy can be easily extended to continuous processes with both internal and external coordinates. The 2-D population balance equation for a batch granulation process is:

$$\begin{aligned} \frac{\partial}{\partial t} f(v, v_L, t) = & -\frac{\partial}{\partial v} \left[ \frac{dv}{dt} f(v, v_L, t) \right] - \frac{\partial}{\partial v_L} \left[ \frac{dv_L}{dt} f(v, v_L, t) \right] \\ & + \frac{1}{2} \int_0^v \int_0^{\min(v_L, v-v')} \beta(v-v', v_L-v'_L, v', v'_L) \\ & \times f(v-v', v_L-v'_L, t) f(v', v'_L, t) dv'_L dv' \\ & - f(v, v_L, t) \int_0^\infty \int_0^{v_L} \beta(v, v_L, v', v'_L) f(v', v'_L, t) dv'_L dv' \end{aligned} \quad (3.15)$$

The relationship between the bivariate number density function  $f$  and single-variant number density function  $n$  is determined as:

$$n(v, t) = \int_0^v f(v, v_L, t) dv_L \quad (3.16)$$

For the aggregation-only processes, the first two terms on the right-hand side of representing convective particle transport and particle growth by layering are negligible. Equation 3.15 is reduced to:

$$\begin{aligned} \frac{\partial}{\partial t} f(v, v_L, t) = & + \frac{1}{2} \int_0^v \int_0^{\min(v_L, v-v')} \beta(v-v', v_L-v'_L, v', v'_L) \\ & \times f(v-v', v_L-v'_L, t) f(v', v'_L, t) dv'_L dv' \\ & - f(v, v_L, t) \int_0^\infty \int_0^{v_L} \beta(v, v_L, v', v'_L) f(v', v'_L, t) dv'_L dv' \end{aligned} \quad (3.17)$$

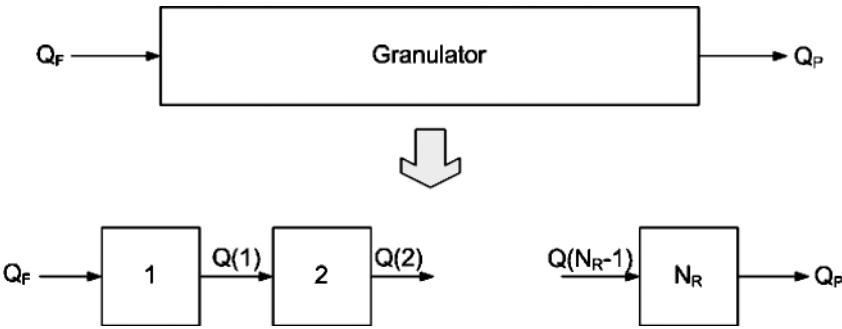
Under certain mathematical assumptions, a two-dimensional population balance equation can be reduced to two single-dimension population balance equations that are described in the following section.

### 3.4. Reduced Order Models

#### 3.4.1. Reduced Order Models Using the Concept of Lumped Regions in Series

When particle populations are spatial-dependent, such as that in a long rotating drum granulator, the population balance model is described in Eq. 3.13 with spatial variable  $z$  included in the model equation. In many industrial applications, the concept of lumped regions in series is used to reduce the model order. By using this method, a granulator is divided into a number of sections with an assumption that perfect mixing can be achieved in each section. The basic idea is schematically depicted in [Figure 3](#).

In [Figure 3](#),  $Q$  denotes the number flow -rate, the subscripts  $F$  and  $P$  represent the feed and product streams, respectively, and  $N_R$  is the total number of regions



**Figure 3** Concept of lumped regions in series.

used to approximate the granulator. The reduced order model Eq. 3.13 for using the method of lumped regions in series is given by:

$$\begin{aligned}
 \frac{\partial}{\partial t} n(v, i, t) = & -\frac{\partial}{\partial v} [G_i n(v, i, t)] + Q(i-1) \frac{n(v, i-1, t)}{n_t(i-1, t)} - Q(i) \frac{n(v, i, t)}{n_t(i, t)} \\
 & + \frac{1}{2} \int_0^v \beta(v-v', v') n(v-v', i, t) n(v', i, t) dv' \\
 & - n(v, i, t) \int_0^\infty \beta(v, v') n(v', i, t) dv'
 \end{aligned} \tag{3.18}$$

$i = 1, 2, \dots, N_R$

where  $i$  represents the  $i$ th region,  $n_t$  is the total number density, and  $Q(0) = Q_F$ .

### 3.4.2. Model Order Reduction for Multi-Dimensional Population Balances

Biggs et al. (7) have developed the concept of binder size distribution (BSD) to correlate moisture content with particle size. Based on BSD, the mass of binder in the size range  $(v, v + dv)$  is quantified as  $dM = M(v) dv$  and:

$$M(t, v) = \rho_L \int_0^v v_L f(v, v_L, t) dv_L \tag{3.19}$$

where  $\rho_L$  is the binder density.

They showed that if the assumption that at a given size all granules have the same liquid content, the 2-D population balance equation given by Eq. 3.17 can be reduced to a set of two, one-dimensional equations described as follows:

$$\begin{aligned}
 \frac{\partial}{\partial t} n(v, t) = & \frac{1}{2} \int_0^v \beta(v-v', v') n(v-v', t) n(v', t) dv' \\
 & - n(v, t) \int_0^\infty \beta(v, v') n(v', t) dv
 \end{aligned} \tag{3.20}$$

$$\begin{aligned}
 \frac{\partial}{\partial t} M(v, t) = & \frac{1}{2} \int_0^v \beta(v-v', v') M(v-v', t) n(v', t) dv' \\
 & - M(v, t) \int_0^\infty \beta(v, v') n(v', t) dv
 \end{aligned} \tag{3.21}$$

In their experiments, pharmaceutical materials were granulated in a high-shear mixer. Good agreements between experimental and simulation results were achieved

enabling the granulation rates to be defined by two parameters: the critical binder volume fraction and the aggregation rate constant.

### 3.4.3. Reduced Order Models Using the Method of Moments

The moments are defined as:

$$\begin{aligned} M_j &= \int_0^\infty v^j n(v) dv \\ \mu_j &= M_j / M_0 \\ j &= 0, 1, 2, \dots \end{aligned} \quad (3.22)$$

Because of the variety of coalescence kernels, it is impossible to develop a generalized structure for reduced order models using the method of moments. A special kernel model is assumed in this work. The methodology can be extended to the development of moment models with different kernel structures. The sample kernel model is assumed as:

$$\beta(v, v') = \beta_0 \frac{v^b + v'^b}{(vv')^a} = \beta_0 \left[ \frac{v'^{(b-a)}}{v^a} + \frac{v^{(b-a)}}{v'^a} \right] \quad (3.23)$$

The discretized format of Eq. 3.23 is given by:

$$\beta_{i,j} = \beta_0 \left[ \frac{v_j^{(b-a)}}{v_i^a} + \frac{v_i^{(b-a)}}{v_j^a} \right] \quad (3.24)$$

The one-dimensional aggregation-only population balance equation (PBE) described by Eq. 3.20 with the kernel model given by Eq. 3.24 can be reduced to a set of ordinary differential equations as follows:

$$\begin{aligned} \frac{d}{dt} M_0 &= -\beta_0 \left( \mu_{(b-a)} \mu_{-a} \right) M_0 \\ \frac{d}{dt} M_1 &= 0 \\ \frac{d}{dt} M_r &= \frac{1}{2} \beta_0 \sum_{k=1}^{r-1} \binom{r}{k} \left[ \mu_{(k-a)} \mu_{(r-k+b-a)} + \mu_{(k+b-a)} \mu_{(r-k-a)} \right] M_0^2, \\ r &= 2, 3, \dots \end{aligned} \quad (3.25)$$

where  $\mu$  is defined in Eq. 3.22, for example,  $\mu_{(k-a)} = M_{(k-a)} / M_0$ . Equation 3.25 involves the determination of fractional and negative moments. If the type of particle size distribution is more or less known, such as log-normal or  $\Gamma$ -distribution, Eq. 3.25 is solvable with the incorporation of interpolation and extrapolation techniques. For more general solution techniques, fractional calculus enabling the computation of fractional differentiations and integrations should be used, which exceeds the scope of this chapter.

### 3.4.4. Multitimescale Analysis

It is often the case that in an interconnected process situation where several processes are being simulated simultaneously that processes operate on distinct time-scales. Such is the case when combinations of prereaction units are combined with granulation devices, dryers, and screening in full process flowsheet simulations.

It can also be the case within a particular processing unit that incorporates a range of mechanisms.

It can be observed that these processes often operate on different timescales covering the range of microseconds to minutes or even hours. This time separation in scales provides opportunity to make assumptions that can simplify the modeling by separating the phenomena into at least three classes:

- Slow modes (long time constant behavior)
- Medium modes
- Fast modes (short time constants)

When we do this analysis, we can often use qualitative methods based on our general understanding of physics, chemistry, and the rate processes such as heat and mass transfer. The alternative and more complex analytical approach is through the use of eigenvalue and eigenvector analysis (37), which is based on the underlying models of the processes. This analysis often allows us to simplify complex models when we model for particular goals by making the following assumptions:

- Slow modes can be treated as being constant over the timeframe of interest.
- Medium modes are modeled in detail
- Fast modes are regarded as pseudosteady states, being represented by algebraic equations.

This timescale approach can simplify significantly the complexity of the process models depending on the timeframe of interest in the simulation and the approach has general application to all forms of models.

## 4. SOLVING AND USING POPULATION BALANCES

### 4.1. Solution of Population Balance Equations

#### 4.1.1. Discretization Methods

**4.1.1.1. Hounslow Discretization.** Hounslow et al. (16) developed a relatively simple discretization method by employing an M-I approach (the mean value theorem on frequency). The population balance equations, such as Eq. 3.20, are normally developed using particle volume as the internal coordinate. Because of the identified advantages of length-based models, Hounslow et al. (16) performed the coordinate transformation to convert the volume-based model described by Eq. 3.20 to a length-based model as follows:

$$\begin{aligned} \frac{d}{dt}n(L, t) = & \frac{L^2}{2} \int_0^L \frac{\beta \left[ (L^3 - \lambda^3)^{1/3}, \lambda \right] n \left[ (L^3 - \lambda^3)^{1/3}, t \right] n(\lambda, t)}{(L^3 - \lambda^3)^{2/3}} d\lambda \\ & - n(L, t) \int_0^\infty \beta(L, \lambda) n(\lambda, t) d\lambda \end{aligned} \quad (4.1)$$

in which  $L$  and  $\lambda$  denote the characteristic length of particles. The Hounslow method is based on a geometric discretization with the following ratio between two successive size intervals:

$$L_{i+1}/L_i = \sqrt[3]{2}, \quad \text{or} \quad v_{i+1}/v_i = 2 \quad (4.2)$$

where  $L$  and  $v$  represent the characteristic length and volume of particles, respectively, the subscripts  $i + 1$  and  $i$  denote the size classes. The continuous population balance equation described by Eq. 4.1 is converted into a set of discretized population balance equations in various size intervals by using this technique. That is, the change of number density in the  $i$ th size interval is given by:

$$\begin{aligned} \frac{d}{dt}n_i &= n_{i-1} \sum_{j=1}^{i-2} (2^{j-i+1} \beta_{i-1,j} n_j) + \frac{i}{2} \beta_{i-1,i-1} n_{i-1}^2 \\ &\quad - n_i \sum_{j=1}^{i-1} (2^{j-i} \beta_{i,j} n_j) - n_i \sum_{j=1}^{i_{\max}} (\beta_{i,j} n_j) \end{aligned} \tag{4.3}$$

$i = 1, 2, \dots, i_{\max}$

The continuous binder size distribution model described by Eq. 3.21 can also be discretized using a similar numerical scheme as follows (7):

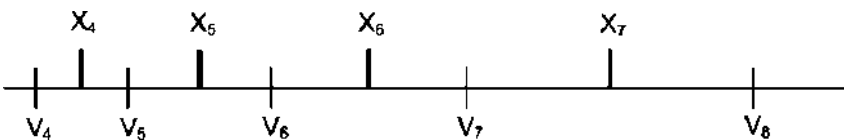
$$\begin{aligned} \frac{d}{dt}M_i &= M_{i-1} \sum_{j=1}^{i-2} (2^{j-i+1} \beta_{i-1,j} n_j) + n_{i-1} \sum_{j=1}^{i-2} (2^{j-i+1} \beta_{i-1,j} n_j) \\ &\quad + n_i \sum_{j=1}^{i-1} [(1 - 2^{j-i}) \beta_{i,j} M_j] + \beta_{i-1,i-1} n_{i-1} M_{i-1} \\ &\quad - M_i \sum_{j=1}^{i-1} (2^{j-i} n_j) - M_i \sum_{j=1}^{i_{\max}} (\beta_{i,j} n_j) \end{aligned} \tag{4.4}$$

$i = 1, 2, \dots, i_{\max}$

**4.1.1.2. Kumar and Ramkrishna’s Discretization Technique.** Kumar and Ramkrishna (22) developed a discretization method by using a grid with a more general and flexible pattern with fine or coarse discretizations in different size ranges. The size range between two sizes  $v_i$  and  $v_{i+1}$  is called the  $i$ th section, and the particle size in this section is simply denoted by  $x_i$  (grid point) such that  $v_i < x_i < v_{i+1}$  as seen in Figure 4.

A particle of size  $v$  in the size range  $x_i$  and  $x_{i+1}$  can be represented by two fractions  $a(v, x_i)$  and  $b(v, x_{i+1})$  associated with the two grid points  $x_i$  and  $x_{i+1}$ , respectively. For the conservation of two general properties  $f_1(v)$  and  $f_2(v)$ , these fractions satisfy the following equations:

$$\begin{aligned} a(v, x_i) f_1(x_i) + b(v, x_{i+1}) f_1(x_{i+1}) &= f_1(v) \\ a(v, x_i) f_2(x_i) + b(v, x_{i+1}) f_2(x_{i+1}) &= f_2(v) \end{aligned} \tag{4.5}$$



**Figure 4** General grid used with Kumar & Ramkrishna numerical technique.

By using this composition technique for particle properties, discrete equations for coalescence-only population balance model given by Eq. 3.20 have been formulated as follows:

$$\frac{dn_i}{dt} = \sum_{\substack{j \geq k \\ x_{i-1} \leq (x_j + x_k) \leq x_{i+1}}} \left(1 - \frac{1}{2} \delta_{j,k}\right) \eta \beta(j, k) n_j(t) n_k(t) - n_i(t) \sum_{k=1}^{i_{\max}} \beta(i, k) n_k(t) \quad (4.6)$$

In Eq. 4.6,  $n_i$ ,  $\beta$ ,  $i_{\max}$  are defined previously,  $\delta_{j,k}$  is the Dirac-delta function, and  $\eta$  is defined as follows:

$$\begin{aligned} \eta &= \frac{x_{i+1} - v}{x_{i+1} - x_i}, & x_i \leq v \leq x_{i+1} \\ \eta &= \frac{v - x_{i-1}}{x_i - x_{i-1}}, & x_{i-1} \leq v \leq x_i \end{aligned} \quad (4.7)$$

The first and second terms on the right-hand side of Eq. 4.6, respectively, represent the birth rate and death rate of particles because of the  $i$ th size interval coalescence.

Attention should be paid to the selection of the internal coordinates. The original Kumar–Ramkrishna discretization should be applied to volume-based models rather than length-based models. Although both are interconvertible, it is important to check consistency in numerical computations.

#### 4.1.2. Wavelet-Based Methods

The wavelet-based methods are relatively new numerical schemes for solving population balance equations consisting of both differential and integral functions (28). Again, the volume-based population balance equations with particle volume as the internal coordinate are used to demonstrate the main characteristics of the wavelet methods. The most important advantage of these methods over other numerical techniques is their ability to effectively deal with steep moving profiles. Here, we only explain the basic algorithms of the wavelet collocation method for practical applications using the Daubechies wavelets rather than provide mathematical insights for general wavelet techniques.

Similar to other collocation methods, the coordinates should be normalized within the interval  $[0, 1]$ . For the 1-D population balance equation given by Eq. 3.11, this can be done by introducing the linear transformation  $x = v/v_{\max}$ , where  $x$  is the dimensionless particle volume and  $v_{\max}$  is the maximum particle size in the system. The original integral intervals  $[0, v]$  and  $[0, \infty]$  are transformed to  $[0, x]$  and  $[0, 1]$ , respectively. Consequently, Eq. 3.11 becomes:

$$\begin{aligned} \frac{\partial}{\partial t} n(x, t) &= - \frac{\partial}{\partial x} [G(x)n(x, t)] \\ &+ \frac{v_{\max}}{2} \int_0^x \beta(x - x', x') n(x - x', t) n(x', t) dx' \\ &- v_{\max} n(x, t) \int_0^1 \beta(x, x') n(x', t) dx' \end{aligned} \quad (4.8)$$

where  $G(x)$  is defined as  $dx/dt$  rather than  $dv/dt$ . For a broad class of engineering problems, the approximate solution of a general function  $w(x)$  with  $J$ -level resolution

can be written in terms of its values in the dyadic points:

$$w_J(x) \approx \sum_m w_J(2^{-J}m)\theta(2^Jx - m) \tag{4.9}$$

where  $\theta(x)$  is denoted as the autocorrelation function of scaling function. We first solve the coalescence-only PBE with  $G(x)=0$ . If J-level wavelet method is used, the matrix representation at the  $i$ th dyadic point is given by:

$$\frac{\partial n_i}{\partial t} = \frac{v_{\max}}{2} [n_0 \quad n_1 \quad \dots \quad n_{2^J}] \mathbf{M}^{3,i} \begin{bmatrix} n_0 \\ n_1 \\ \vdots \\ n_{2^J} \end{bmatrix} - v_{\max} n_i \mathbf{M}_i^2 \begin{bmatrix} n_0 \\ n_1 \\ \vdots \\ n_{2^J} \end{bmatrix} \tag{4.10}$$

where  $n_i$  is the number density at the  $i$ th dyadic (collocation) point. The operational matrix  $\mathbf{M}^{3,i}$  and vector  $\mathbf{M}_i^2$  are constructed as follows.  $\mathbf{M}^{3,i}$  are  $(2^J + 1) \times (2^J + 1)$  operational matrices at volume points are represented as:

$$\mathbf{M}^{3,i} = \begin{bmatrix} M_{0,0}^{3,i} & M_{0,1}^{3,i} & \dots & M_{0,2^J}^{3,i} \\ M_{1,0}^{3,i} & M_{1,1}^{3,i} & \dots & M_{1,2^J}^{3,i} \\ \vdots & \vdots & \ddots & \vdots \\ M_{2^J,0}^{3,i} & M_{2^J,1}^{3,i} & \dots & M_{2^J,2^J}^{3,i} \end{bmatrix} \tag{4.11}$$

$\mathbf{M}_i^2$  are  $1 \times (2^J + 1)$  operational vectors at volume points and are described by:

$$\mathbf{M}_i^2 = [M_{i,0}^2 \quad M_{i,1}^2 \quad \dots \quad M_{i,2^J}^2]$$

Elements in matrix  $\mathbf{M}^{3,i}$  are developed as:

$$M_{k_1,k_2}^{3,i} = \frac{1}{2^J} \sum_{l=0}^{2^J} \beta(x_i - x_l, x_l) \times (\Omega_{l-k_2,i-k_1-k_2}(i - k_2) - \Omega_{l-k_2,i-k_1-k_2}(-k_2)) \tag{4.12}$$

Elements in the operational vectors  $\mathbf{M}_i^2$  are given by:

$$M_{i,k}^2 = \frac{1}{2^J} \left[ \sum_{l=0}^{2^J} \beta(x_i, x_l) H_{k-l}(k) \right] \tag{4.13}$$

The required two-term integral of autocorrelation function  $H_k(x)$  and three-term integral of autocorrelation function  $\Omega_{j,k}(x)$  in Eqs. 4.12 and 4.13 are defined as:

$$H_k(x) = \int_{-\infty}^x \theta(y - k)\theta(y)dy \tag{4.14}$$

$$\Omega_{j,k}(x) = \int_{-\infty}^x \theta(y - j)\theta(y - k)\theta(y)dy \tag{4.15}$$

The autocorrelation function  $\theta(k)$  and its derivatives  $\theta^{(s)}(k)$  are represented as follows:

$$\begin{aligned} \theta(k) &= \int_{-\infty}^{+\infty} \phi(x)\phi(x - k) dx \\ \theta^{(s)}(k) &= (-1)^s \int_{-\infty}^{+\infty} \phi(x)\phi^{(s)}(x - k) dx \end{aligned} \tag{4.16}$$



where  $\varphi(x)$  is the scaling function.  $\theta^{(s)}(k)$  can be evaluated by using the following recursive algorithm with  $\theta(k) = \theta^{(0)}(k)$ :

$$\begin{aligned} \theta^{(s)}(2^{-J-1}k) &= 2^s \theta^{(s)}(2^{-J}k) + 2^{s-1} \sum_{l=1}^N a_{2l-1} (\theta^{(s)}(2^{-J}k - 2l + 1) \\ &\quad + \theta^{(s)}(2^{-J}k - 2l - 1)) \end{aligned} \tag{4.17}$$

The differential operators in the PBE can also be evaluated at the collocation points as:

$$\begin{aligned} \frac{\partial \mathbf{n}}{\partial x} &= \mathbf{A}(\theta^{(1)})\mathbf{n} \\ \frac{\partial^2 \mathbf{n}}{\partial x^2} &= \mathbf{B}(\theta^{(2)})\mathbf{n} \end{aligned} \tag{4.18}$$

where  $\mathbf{n} = [n_1, n_2, \dots, n_N]^T$  is a vector in which  $n_i$  is the number density at the  $i$ th collocation point,  $N = 2^J + 1$  is the number of collocation points,  $T$  stands for vector transpose,  $\mathbf{A}$  and  $\mathbf{B}$  are square matrices computed using the values  $\theta^{(1)}(k)$  and  $\theta^{(2)}(k)$ , respectively. An algorithm for the computation of the matrices  $\mathbf{A}$  and  $\mathbf{B}$  was described in Liu et al. (27). Consequently, the growth term in Eq. 4.8 can be approximated using Eq. 4.18.

It should be pointed out that after coordinate normalization, functions of interest are evaluated in the closed intervals  $[0, 1]$ , rather than in  $[-\infty, \infty]$  or other intervals. In this case, some modified interpolation functions can be constructed to interpolate the values in dyadic points outside  $[0, 1]$  to the desired interval (6,25).

Three population balance equations with different kernel models have been successfully solved by using the wavelet collocation method (28). These kernel models were: (1) size-independent kernel  $\beta = \beta_0 = \text{constant}$ , (2) linear size-dependent kernel  $\beta(x, x') = \beta_0(x + x')$ , and (3) nonlinear size-dependent kernel  $Q(x, x') = \beta(x^{1/3} + x'^{1/3})(x^{1/3} + x'^{1/3})$ . Simulation results have shown that the wavelet collocation methods are able to achieve fast convergence with high accuracy if adequate resolution levels are selected. The methods are particularly effective for the processes with steep moving profiles that are difficult to solve by using other numerical schemes.

Here, emphasis has been placed on the introduction of basic techniques for the resolution of population balance equations using wavelets, which is required to solve  $2^J + 1$  ordinary equations for each population balance equation given by Eq. 4.8. Recently, Liu and Cameron (29) have developed a new wavelet-based adaptive technique, which enables a dramatic reduction of the number of ordinary differential equations to be solved. Furthermore, this adaptive method allows the automatic selection of the minimum wavelet level  $J$  with acceptable accuracy. With the background knowledge described in this chapter, readers may understand the adaptive technique through studies on the original papers without major difficulties.

Website on the wavelet collocation methods for the computations of population balance equations. The operational matrices  $\mathbf{M}^{3,i}$  and  $\mathbf{M}_i^2$ , matrices  $\mathbf{A}$  and  $\mathbf{B}$ , together with the integral functions  $\mathbf{H}$  and  $\mathbf{\Omega}$  at various resolution levels are available at <http://www.cheque.uq.edu.au/psdc>.

### 4.1.3. Solving Differential-Algebraic Equation DAE Systems

Many of the previously mentioned numerical methods lead to large sets of differential equations coupled with sets of nonlinear algebraic equations. These are the

so-called DAE systems. A number of approaches are available to solve these equation sets, mainly based on implicit or semi-implicit methods such as the backward differentiation formulae (BDF) (34) or variants of Runge–Kutta methods (9,53).

The Mathworks package MATLAB<sup>TM</sup> also contains useful DAE solvers in the latest versions that are based primarily on implicit BDF formulae. Solutions of these types of problems are generally straightforward. Some issues still remain in obtaining consistent initial conditions for the solution to commence.

## 4.2. Monte Carlo Methods

There is a long history in studies on application of Monte Carlo methods to process engineering. The first serious research paper on a Monte Carlo treatment for systems involving population balances could be credited to Spielman and Levenspiel (42). Since then, a significant number of publications have appeared in the literature on the resolution of population balance equations using Monte Carlo methods (35). Comprehensive Monte Carlo treatments are described in the literature (20,35). Only selected issues on basic techniques are addressed in this section.

### 4.2.1. Classification of Monte Carlo Methods

Monte Carlo methods can be used in two ways for engineering applications.

1. Direct evaluation of difficult functions. For example, the integral given by:

$$I = \int_a^b f(x) dx \quad (4.19)$$

can be evaluated as:

$$I = E(Y) = E[(b-a)g(X)] = E[\bar{Y}(n)] \quad (4.20)$$

$$\bar{Y}(n) = \dots (b-a) \frac{\sum_{i=1}^n g(X_i)}{n}$$

where  $X_1, X_2, \dots, X_n$  are random variables defined in the closed interval  $[a, b]$ , and  $E(Y)$  denotes the mathematical estimation of function  $Y$ .

2. Artificial realization of the system behavior (35). This method is commonly applied to complex particulate processes, which are described in some detail here. In the artificial realization, the direct evaluation of integral and differential functions is replaced by the simulation of the stochastic behavior modeled by using a randomness generator to vary the behavior of the system (20). The important probabilistic functions in the original model equations, such as coalescence kernels for granulation processes, are still essential in Monte Carlo simulations and are shown later.

Monte Carlo methods for the artificial realization of the system behavior can be divided into time-driven and event-driven Monte Carlo simulations. In the former approach, the time interval  $\Delta t$  is chosen, and the realization of events within this time interval is determined stochastically. Whereas in the latter, the time interval between two events is determined based on the rates of processes. In general, the coalescence rates in granulation processes can be extracted from the coalescence kernel models. The event-driven Monte Carlo can be further divided into constant volume methods

in which the total volume of particles is conserved, and the constant number method in which the total number of particles in the simulation remains constant. The main advantage of the constant number method for granulation processes is that the population remains large enough for accurate Monte Carlo simulations (41,52). An additional advantage associated with the constant number methods is its ability to reduce the renumbering effort. Consequently, the constant number method is recommended and is further explained.

#### 4.2.2. Key Equations for Constant Number Monte Carlo Simulation

Key equations needed in Monte Carlo simulations include the interevent time  $\Delta t_q$  representing the time spent from  $q-1$  to  $q$  Monte Carlo steps, coalescence kernel  $K_{ij}$ , normalized probability  $p_{ij}$  for a successful collision between particles  $i$  and  $j$ , and a number of intermediate variables. The coalescence kernel can be divided into particle property independent part  $K_c$  and dependent part  $k_{ij}(\mathbf{X}_i, \mathbf{X}_j)$  as follows:

$$K_{ij} = K_c k_{ij}(\mathbf{X}_i, \mathbf{X}_j) \quad (4.21)$$

$$i, j = 1, 2, \dots, N$$

where  $\mathbf{X}$  denotes the vector of internal coordinates representing particle properties, such as size and moisture content, and  $N$  is the total number in the simulation system. It can be seen that Eq. 4.21 is similar to the coalescence kernel given by  $\beta_{ij} = \beta_0 k_{ij}(v_i, v_j)$  described in the previous sections for one-dimensional systems. However, it should be pointed out that  $i$  and  $j$  in Eq. 4.21 are used to identify the individual particles, whereas that in  $\beta_{ij}$ ,  $i, j = 1, 2, \dots, i_{\max}$  are size classes rather than particle identity numbers. To avoid confusion,  $\beta_{ij}$  and  $\beta_0$  are replaced by  $K_{ij}$  and  $K_c$ , respectively, in Monte Carlo simulations. The normalized probability for successful collision is given by:

$$p_{ij} = \frac{k_{ij}}{k_{\max}} \quad (4.22)$$

where  $k_{\max}$  is the maximum value of the coalescence kernel among all particles. The final result of the interevent time is given by:

$$\Delta t_q = \frac{2\tau_c}{\langle k_{ij} \rangle} \frac{1}{N} \left( \frac{N}{N-1} \right)^q \quad (4.23)$$

with

$$\tau_c = \frac{1}{K_c C_0} \quad (4.24)$$

and

$$\langle k_{ij} \rangle = \frac{\sum_{i=1}^N \sum_{j=1, i \neq j}^N k_{ij}}{N(N-1)} \quad (4.25)$$

In Eq. 4.25,  $C_0$  is the total number concentration at  $t=0$  defined by  $C_0 = N/V_0$  where  $V_0$  is the volume of particles at the initial time. We presented only the final results of the needed equations here. Interested readers are referred to Smith and Matsoukas (41) for detailed mathematical derivations.

### 4.2.3. Simulation Procedure

The simulation procedure for the constant number Monte Carlo method applied to coalescence processes consists of the following key steps:

1. Initialization of the simulation system. This includes the determination of sample size (normally 10,000–20,000 particles) followed by assigning the identity number and properties to each particle. The properties must satisfy the initial property distributions, such as particle size and moisture distributions. Set  $t_0 = 0$  and  $q = 1$ .
2. Acceptance or rejection of coalescence. In this step, two particles,  $i$  and  $j$ , are randomly selected and the coalescence kernel  $k_{ij}$  with normalised probability  $p_{ij}$  given by Eq 4.22 are computed, followed by the generation of a random probability  $p_{rq}$ . If  $p_{ij} < p_{rq}$ , the coalescence is rejected, and a new pair of particles is selected again to repeat the calculation until  $p_{ij} > p_{rq}$ , which implies a successful coalescence. When the coalescence is successful, the new agglomerated particle holds the identity number  $i$ , and another particle randomly selected from the rest of the system is copied as particle  $j$  and go to Step 3.
3. Computation of the interevent time. The interevent time for step  $q$  is computed using Eqs 4.23–4.25. Total operational time is given by:

$$t = t_0 + \sum_{m=1}^q \Delta t_m \quad (4.26)$$

4. Set  $q = q + 1$  and return to Step 2.
5. Simulation termination and result validation. As  $t$  reaches the prespecified termination time  $t_f$ , check the acceptance of simulation results. If acceptable, stop the simulation; otherwise, modify model parameters and start a new simulation process.

It can be seen that the Monte Carlo methods are applicable to both one-dimensional and multidimensional coalescence processes without any theoretical and algorithmic hurdles. However, most reported results with good agreement with experimental data are limited to one-dimensional systems except that reported by Wauters (52). This is mainly because of the lack of reliable multidimensional kernel models rather than the applicability of Monte Carlo methods.

## 5. APPLICATION OF MODELING TECHNIQUES

### 5.1. Modeling for Closed-Loop Control Purposes

#### 5.1.1. Development of Control Relevant, Linear Models

As the linear control theory and techniques are better developed and easier to implement than their nonlinear counterparts, it is highly desirable to use linear models for control purposes. In process engineering, the nonlinear models are frequently linearized around certain operating points. The linearization technique is described briefly here. Let the general nonlinear system be described as:

$$\begin{cases} \frac{d\mathbf{x}}{dt} = \mathbf{f}(\mathbf{x}, \mathbf{u}) \\ \mathbf{y} = \mathbf{h}(\mathbf{x}) \end{cases} \quad (5.1)$$

where  $\mathbf{x} = [x_1, x_2, \dots, x_p]^T$ ,  $\mathbf{y} = [y_1, y_2, \dots, y_q]^T$ , and  $\mathbf{u} = [u_1, u_2, \dots, u_s]^T$  are vectors of state, output, and control variables, respectively,  $\mathbf{f} = [f_1, f_2, \dots, f_p]^T$  and  $\mathbf{h} = [h_1, h_2, \dots, h_q]^T$  are vectors of smooth functions, in which  $p, q$ , and  $s$  are dimensions of the vectors of state, output and control variables, respectively. In the population balance equations given by Eqs. 4.3, 4.6 and 4.10,  $x = [n_1, n_2, \dots, n_p]$ ,  $p = i_{\max}$ . The conventional linearization method is based on the first-order Taylor series expansion around certain operational points. The resulting linear model is given by:

$$\begin{aligned} \frac{d\delta\mathbf{x}}{dt} &= \mathbf{A}\delta\mathbf{x} + \mathbf{B}\delta\mathbf{u} \\ \delta\mathbf{y} &= \mathbf{C}\delta\mathbf{x} \end{aligned} \tag{5.2}$$

$$\mathbf{A} = \left. \frac{\partial\mathbf{f}(\mathbf{x}, \mathbf{u})}{\partial\mathbf{x}^T} \right|_{\substack{x = x_o \\ u = u_o}}, \mathbf{B} = \left. \frac{\partial\mathbf{f}(\mathbf{x}, \mathbf{u})}{\partial\mathbf{u}^T} \right|_{\substack{x = x_o \\ u = u_o}}, \mathbf{C} = \left. \frac{\partial\mathbf{h}(\mathbf{x})}{\partial\mathbf{x}^T} \right|_{\substack{x = x_o \\ u = u_o}}$$

In the control literature, the symbol  $\delta$  in front of  $x, y$ , and  $u$  is normally omitted for simplicity. The readers should be aware that in the models developed this way,  $x, y$ , and  $u$  denote deviations from their respective values at the specified operational point rather than the real values. That is, the linearized model used in control studies is represented as:

$$\begin{aligned} \frac{d\mathbf{x}}{dt} &= \mathbf{A}\mathbf{x} + \mathbf{B}\mathbf{u} \\ \mathbf{y} &= \mathbf{C}\mathbf{x} \end{aligned} \tag{5.3}$$

The discretized population balance equations given by Eqs. 4.3, 4.6 and 4.10, and the binder size distribution model described by Eq. 4.4 can be linearized to obtain the models with the format given by Eq. 5.3. The control variables are normally connected with the coalescence kernels (55).

5.1.2. ARX and ARMAX Models for Linear Model Predictive Control

For model predictive control purposes, there are two commonly used black box models: ARX model with autoregressive (AR) part and extra (X) input, and ARMAX model with additional moving average (MA) part accounting for disturbances. The method for the development of ARX and ARMAX models is well explained by Ljung (30). The single input, single output ARX is given by:

$$y(t) + a_1y(t - 1) + \dots + a_{n_a}y(t - n_a) = b_1u(t - 1) + \dots + b_{n_b}u(t - n_b) + e(t) \tag{5.4}$$

and the ARMAX model is represented as:

$$\begin{aligned} y(t) + a_1y(t - 1) + \dots + a_{n_a}y(t - n_a) = \\ b_1u(t - 1) + \dots + b_{n_b}u(t - n_b) + e(t) + c_1e(t - 1) + \dots + c_{n_c}e(t - n_c) \end{aligned} \tag{5.5}$$

In Eqs. 5.4 and 5.5,  $y$  is the output (controlled) variable;  $u$  is the input (manipulative) variable,  $e$  is the disturbance;  $a, b$ , and  $c$  are time varying coefficients identified on-line;  $n_a, n_b$ , and  $n_c$  are defined as prediction, control, and disturbance horizons.

The matrix format for multivariable RRX and ARMAX models is described by:

$$\mathbf{A}(q)\mathbf{y}(t) = \mathbf{B}(q)\mathbf{u}(t) + \mathbf{e}(t) \quad (\text{ARX}) \quad (5.6)$$

$$\mathbf{A}(q)\mathbf{y}(t) = \mathbf{B}(q)\mathbf{u}(t) + \mathbf{C}(q)\mathbf{e}(t) \quad (\text{ARMAX}) \quad (5.7)$$

In Eqs (5.6) and (5.7), matrices  $\mathbf{A}$ ,  $\mathbf{B}$ , and  $\mathbf{C}$  are defined as:

$$\begin{aligned} \mathbf{A}(q) &= \mathbf{I}_{n_y} + \mathbf{A}_1 q^{-1} + \cdots + \mathbf{A}_{n_a} q^{-n_a} \\ \mathbf{B}(q) &= \mathbf{B}_0 + \mathbf{B}_1 q^{-1} + \cdots + \mathbf{B}_{n_b} q^{-n_b} \\ \mathbf{C}(q) &= \mathbf{C}_0 + \mathbf{C}_1 q^{-1} + \cdots + \mathbf{C}_{n_c} q^{-n_c} \end{aligned} \quad (5.8)$$

where  $q^{-k}$  is the delay operator representing “delayed by  $k$  time intervals,” for example:

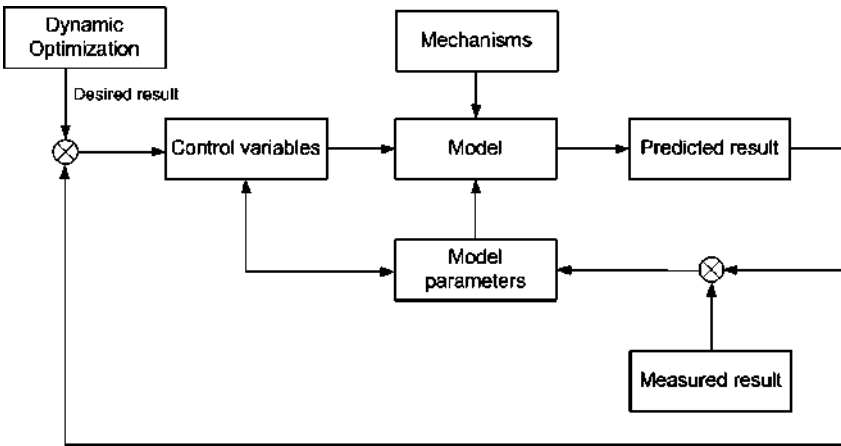
$$\mathbf{A}(q)\mathbf{y}(t) = \mathbf{y}(t) + \mathbf{A}_1\mathbf{y}(t-1) + \cdots + \mathbf{A}_{n_a}\mathbf{y}(t-n_a) \quad (5.9)$$

The compact format of ARX and ARMAX models given by Eqs 5.6 and 5.7 can be easily converted into more intuitive, expanded format exemplified by Eq. 5.9. With input ( $\mathbf{u}$  and  $\mathbf{e}$ ) and output ( $\mathbf{y}$ ) data, the matrices  $\mathbf{A}$ ,  $\mathbf{B}$  and  $\mathbf{C}$  can be readily identified employing the System Identification Toolbox for Use with MATLAB<sup>TM</sup> (31). An ARX model for a pan, granulation process was developed by Adetayo et al. (3) with a successful application for effective control of the plant.

### 5.1.2. Nonlinear Model Predictive Control Structure

Nonlinear model predictive control (NMPC) schemes consist of simultaneous determinations of manipulative variables and uncertain parameters. In some cases, the open-loop dynamic optimization is carried out for the determination of desired trajectories (set-points). This integrated control strategy was developed by Miller and Rawlings (32a) in a study on model identification and control for batch cooling crystallizers, in which the population balance described by partial differential equation was reduced to a low-dimensional model using method of moments. That is, the control objective was of average size rather than the size distribution in Miller and Rawlings’ work. Detailed studies on modeling and model predictive control (MPC) of particle size distribution in emulsion co-polymerization processes using population balance models have been carried out by Immanuel et al. (17) and Crowley et al. (10). The reported research results have shown that the NMPC schemes using population balance equations should also be applicable to pharmaceutical granulation processes because of the similar model structure. A general structure for nonlinear model predictive control is shown in Figure 5, which depicts an integration of the modeling strategy originally proposed by Sanders et al. (39) with the model based control scheme.

A full implementation of NMPC in industrial granulation plants using physically based models has not been reported yet. A simulated study has been carried out by Zhang et al. (55) to control an industrial-scale fertilizer plant using a physically based model. The main limitation of the study was that the physically based population balance model was used to generate output data without real on-line measurements. This implies that if a severe plant-model mismatch occurs, the proposed control strategy may fail. Further work is required to modify the model on-line, based on the measurement data.



**Figure 5** General structure of NMPC using physically based models.

5.1.3. On-Line Measurement-Based Control Schemes

In addition to model-based control schemes using population balance equations, there are a number of practical control schemes in the pharmaceutical industry, that do not rely on mathematical models. These include simple feedback control with or without feed-forward compensation, and fuzzy-logic control systems.

**5.1.3.1. Simple Feedback Control with Feed-Forward Compensation.** One of the most important issues for the effective control of granulation processes is the development of fast and reliable measurement techniques for the characterization of particulate systems. Because of the difficulties associated with the direct measurement of particle characteristics, such as particle size distribution, moisture content, and deformability, some indirect monitoring parameters have been adopted as the indicators of particle characteristics. A commonly accepted monitoring parameter in the pharmaceutical industry is power consumption, which has been successfully used to control the particle size in high-shear mixers at the end-point (12,23). Based on a series of investigations carried out by Leuenberger, (23), the energy dissipated per unit volume in a high-shear mixer,  $dW/dV$ , can be approximately represented as:

$$\frac{dW}{dV} = \mu\sigma_c\kappa \propto \frac{1 - \varepsilon}{\varepsilon} \tag{5.10}$$

where  $W$  is the power consumption,  $V$  is the granulator volume,  $\mu$  is the apparent coefficient of friction,  $\sigma_c$  is the cohesive stress,  $\kappa$  is the dimensionless shear rate, and  $\varepsilon$  is the porosity of the powder mass. It is easy to show that power consumption is related to the saturation level  $S$  and is defined as follows:

$$S = \frac{H(1 - \varepsilon)}{\varepsilon} \rho \tag{5.11}$$

where  $H$  is the mass ratio of liquids to solids, and  $\rho$  is the density of the particle relative to that of the liquid ( $\rho = \rho_S/\rho_L$ ). Furthermore, Kristensen and Schaefer (21) pointed out that the saturation level defined by Eq. 5.11 could be related back to the average granule size. Consequently, the power consumption, the saturation level, and the granule particle size are inter-related, which forms a technical basis to use

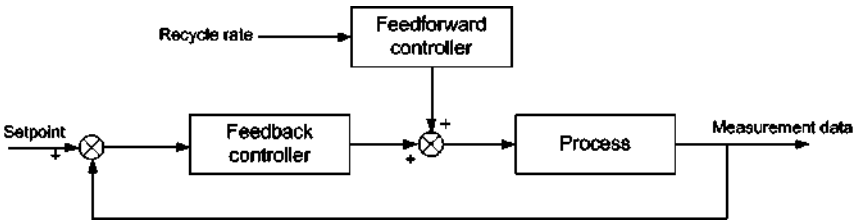


Figure 6 Simple feedback control scheme with feed-forward compensation.

power consumption as a monitoring parameter for the characterization of particles within the high-shear mixer. A detailed description of the control strategy using.

Mort et al. (33) pointed out that: “With recent development in particle sizing technology, the agglomerate size distribution can be measured in-line at any number of points in the process.” The main measurement technique is image analysis by mounting high-speed cameras and lighting systems in appropriate locations. As the direct measurement data of particle sizes are available, the controller design can be based on these data without relying on the indirect indicators under the condition that the rate of binder addition is sufficiently slow to allow for image data to be collected, processed, and fed back. This concept has been used for batch granulation processes in fluidized beds. The same authors also proposed a feed-forward control strategy to compensate the fluctuation of the recycle rate. The simple feedback control with feed-forward compensation scheme is shown in Figure 6.

The measurement data in Figure 6 could be the indirect monitoring parameters (23) or the explicit particle size distribution (33), depending on the relative speed of the measurement system and process dynamics.

**5.1.3.2. Fuzzy-Logic Control of High-Shear Granulation.** Watano et al. (50,51) have developed a novel system to control granule growth in a high-shear mixer. The system basically consisted of image processing and a fuzzy controller as shown in Figure 7.

In Figure 7,  $D(t)$  is the deviation between the desired value ( $D_d$ ) and the measured value ( $D_m$ ) of granule size, and  $\Delta D(t)$  denotes the change rate of measured values that are mathematically represented as follows:

$$\begin{aligned}
 D(t) &= D_d - D_m(t) \\
 \Delta D(t) &= D_m(t) - D_m(t - 1)
 \end{aligned}
 \tag{5.12}$$

Other notations in Figure 7 are as follows.  $V(t)$  is the result of fuzzy reasoning used to control the output power of liquid feed pump, while  $K_1$  and  $K_2$  represent gains of the input variables.

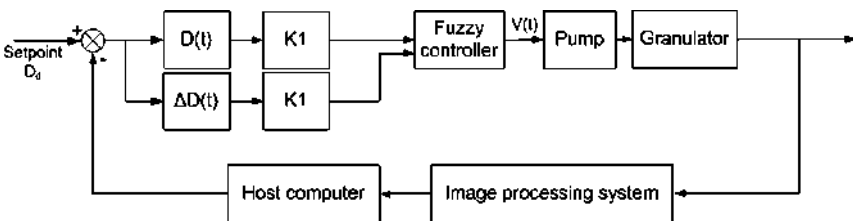


Figure 7 Block diagram of granule size control system (after Watano et al., 2001).



In the methodology developed by Watano et al. (50,51), four fuzzy variables were used, namely ZR (zero), PS (positive small), PM (positive medium) and PL (positive large). The values of  $D(t)$ ,  $\Delta D(t)$  and  $V(t)$  were all classified into these four categories. Ten rules were proposed to relate measured  $D(t)$  and  $\Delta D(t)$  with  $V(t)$ . Consequently,  $V(t)$  can be quantified using the if-then statement. An example is given as follows:

If  $D(t) = \text{PS}$  and  $\Delta D(t) = \text{PL}$  then  $V(t) = \text{ZR}$  [Rule 2 in Table 2 of Watano et al. (51)].

In this way, all the combinations of  $D(t)$  and  $\Delta D(t)$  can be connected with  $V(t)$  for the effective control of the process. The technique can be considered as highly successful with the experimental justifications.

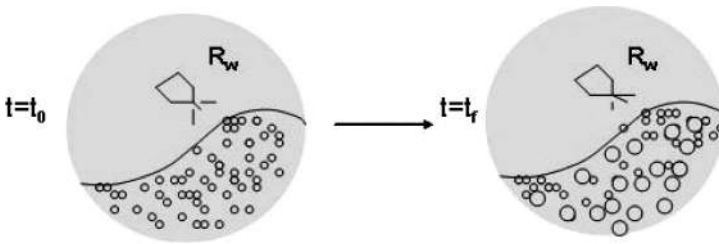
## 5.2. Modeling for Optimal Design, Operation, and Open-Loop Optimal Control

Process optimization and open-loop optimal control of batch and continuous drum granulation processes are described here as another important application example of population balance modeling. Both steady-state and dynamic optimization studies are carried out that consist of: (i) Construction of optimization and control relevant, population balance models through the incorporation of moisture content, drum rotation rate, and bed depth into the coalescence kernels; (ii) Investigation of optimal operational conditions using constrained optimization techniques; and (iii) Development of optimal control algorithms based on discretized population balance equations. The objective of steady-state optimization is to minimize the recycle rate with minimum cost for continuous processes. It has been identified that the drum rotation rate, bed depth (material charge), and moisture content of solids are practical decision (design) parameters for system optimization. The objective for the optimal control of batch granulation processes is to maximize the mass of product-sized particles with minimum time and binder consumption. The objective for the optimal control of the continuous process is to drive the process from one steady state to another in minimum time with minimum binder consumption, which is also known as the state-driving problem. It has been known for some time that the binder spray-rate is the most effective control (manipulative) variable. Although other process variables, such as feed flow rate and additional powder flow rate can also be used as manipulative variables, only the single input problem with the binder spray rate as the manipulative variable is addressed here to demonstrate the methodology. It can be shown from simulation results that the proposed models are suitable for control and optimization studies, and the optimization algorithms connected with either steady-state or dynamic models are successful for the determination of optimal operational conditions and dynamic trajectories with good convergence properties.

It should be pointed out that only open-loop optimal control issues for granulation processes without uncertainty are addressed here. The integration of open-loop optimal control with closed-loop, nonlinear model predictive control (NMPC) for uncertain processes is reported elsewhere by the authors (49).

### 5.2.1. Statement of Optimization and Open-Loop Optimal Control Problems

A typical batch drum granulation process is schematically shown in Figure 8. There are two operational strategies: (1) premix the fine particles with the proper amount of liquid binder followed by the rotating operation until the desired size distribution



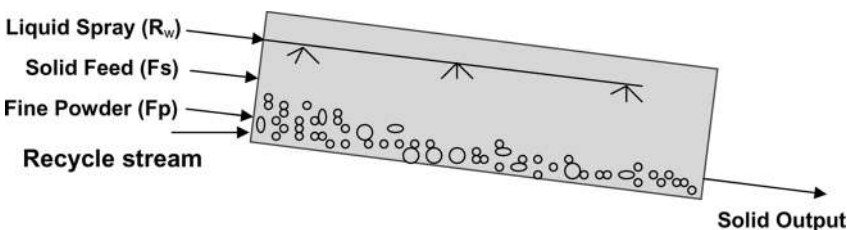
**Figure 8** Schematic diagram of batch drum granulation.

is achieved; and (2) simultaneous mixing and granulating by spraying liquid binder (and fine powders in some cases) on the moving surface of particles inside the rotating drum. The first strategy involves system optimization without any control action. The optimization problem can be stated as: to determine the optimal moisture content, initial size distribution, rotating rate, and bed depth (drum charge), such that the desired size distribution can be obtained within a minimum time  $t_f$ . Optimal control techniques can be applied to the second strategy, which can be stated as: for the specified initial conditions, maximize the mass of product-sized particles in minimum time with minimum energy consumption by adjusting the manipulative variables, such as binder spray rate and drum rotation speed. We discuss the optimal control problem with the binder spray rate as the single manipulative variable in detail.

A slightly modified continuous drum granulation process with an additional fine powder stream is shown in Figure 9. As mentioned previously, the additional fine powder stream is used to improve the controllability of the process, which is not seen in the conventional design. Our studies on continuous drum granulation include the steady-state optimization and optimal state driving from one steady state to another. The objective for steady-state optimization is to achieve minimum recycle rate with minimum cost through the determination of optimal operational conditions, such as rotating rate, binder spray rate, feed flow rate, bed depth, and drum inclination angle. The optimal state driving attempts to drive the system from one steady state to another in a minimum time with minimum energy consumption by adjusting the time-dependent manipulative variables, such as binder spray rate, feed flow rate, and optionally additional fine powder flow rate.

### 5.2.2. Optimization and Open-Loop Optimal Control Equations

The optimization and open-loop optimal control equations consist of model equations and objective functions.



**Figure 9** Schematic diagram of continuous drum granulation.

**5.2.2.1. Optimization and Control Relevant-Model Equations.** The discretized population balance equation for batch system can be described as follows:

$$\frac{d}{dt}n_i = -\frac{\partial}{\partial L}(Gn_i) + B_i - D_i \tag{5.13}$$

$$i = 1, 2, \dots, i_{\max}$$

where  $n_i$ ,  $B_i$ , and  $D_i$  stand for the particle number, birth rate, and death rate in the  $i$ th size interval, respectively; and  $i = 1, 2, \dots, i_{\max}$ , in which  $i_{\max}$  is the total number of size intervals. Similarly, continuous processes can also be represented as:

$$\frac{d}{dt}n_i = -\frac{\partial}{\partial L}(Gn_i) + B_i - D_i + F^{\text{in}}\frac{n_i^{\text{in}}}{n_t^{\text{in}}} - F^{\text{out}}\frac{n_i}{n_t} \tag{5.14}$$

$$i = 1, 2, \dots, i_{\max}$$

where  $F$  is the number flow -rate, the subscript  $t$  indicates the total value, and the superscripts identify the inlet and outlet streams. Using Hounslow’s discretization methods, the relevant terms in the right-hand side of Eqs. 5.13 and 5.14 are given by:

$$B_i = n_{i-1} \sum_{j=1}^{i-2} (2^{j-i+1} \beta_{i-1,j} n_j) + \frac{i}{2} \beta_{i-1,i-1} n_{i-1}^2 \tag{5.15}$$

$$D_i = n_i \sum_{j=1}^{i-1} (2^{i-j} \beta_{i,j} n_j) - n_i \sum_{j=1}^{i_{\max}} (\beta_{i,j} n_j) \tag{5.16}$$

$$\frac{\partial Gn_i}{\partial L} = -\frac{2G}{(1+r)L_i} \left( \frac{r}{r^2-1} n_{i-1} + n_i - \frac{r}{r^2-1} n_{i+1} \right) \tag{5.17}$$

$$r = L_{i+1}/L_i = \sqrt[3]{2}$$

where  $\beta_{i,j}$  is equivalent to the representation  $\beta(L_i, L_j)$ . Consequently, an original population balance equation described by a partial differential-integral equation is converted into a set of ordinary differential equations. It is more convenient to convert the number-based population balance equations described by Eqs. 5.13–5.17 to mass-based ones, which are demonstrated by the authors (48).

A control relevant model was developed by Zhang et al. (55), in which the coalescence kernel is a function of the moisture content. In the newly developed kernel models reported by Balliu (5) and Wang et al. (47,48), in addition to moisture content, the bed depth and drum speed are also incorporated. Two kernel models, namely size-independent kernel and size-dependent kernel, are used in optimization and control simulations. The size-independent kernel is given by:

$$\beta_{i,j} = \beta_0 = a_0 \cdot [(x_m)^{n_1} e^{-a_1 x_m}] \cdot [(B_d)^{n_2} e^{-a_2 B_d}] \cdot (S_d^{n_3} e^{-a_3 S_d}) \tag{5.18}$$

where  $x_m$  is the moisture content in particles,  $B_d$  is the bed depth,  $S_d$  is the drum rotating rate,  $a_0$ – $a_3$  and  $n_1$ – $n_3$  are constants determined through parameter identification techniques based on the measurement data. The size dependent kernel

is represented as (13):

$$\beta_{i,j} = \beta_0 \frac{(L_i + L_j)^2}{L_i L_j} \quad (5.19)$$

where  $\beta_0$  is also defined in Eq. 5.18.

As the main mechanism determining the growth rate  $G$  in Eqs. 5.13 and 5.14 is the layering of the fine powders on the surface of particles, it can be deduced that the growth rate is a strong function of the powder fraction and moisture content. The following correlation is used to calculate the growth rate:

$$G = G_m \cdot \frac{M_{\text{powder}}}{k \cdot \sum M_i + M_{\text{powder}}} \cdot \exp[-a(x_w - x_{wc})^2] \quad (5.20)$$

where  $G_m$  is the maximum growth rate,  $M_{\text{powder}}$  is the mass of fine powder below the lower bound of the particle classes,  $M_i$  is the mass of particles in the  $i^{\text{th}}$  size class,  $x_{wc}$  is the critical moisture,  $k$  and  $a$  are fitting parameters. Studies on powder mass balance lead to the following equations for batch processes:

$$\frac{dM_{\text{powder}}}{dt} = F_{\text{powder}}^{\text{in}} - 3G \int_0^\infty \frac{M(L)}{L} dL \quad (5.21)$$

and continuous processes:

$$\frac{dM_{\text{powder}}}{dt} = F_{\text{powder}}^{\text{in}} - \frac{M_{\text{powder}}}{t_R} - 3G \int_0^\infty \frac{M(L)}{L} dL \quad (5.22)$$

where  $F_{\text{powder}}^{\text{in}}$  represents the flow rate of additional powder stream in both batch and continuous cases. It can be used as an additional manipulative variable.

The liquid mass balance for batch processes is given by:

$$\frac{dx_w}{dt} = \frac{1}{M_t} R_w \quad (5.23)$$

where  $M_t$  is the total mass of solids in the drum and  $R_w$  is the binder spray rate. Similarly, we can develop the liquid mass balance for the continuous process as:

$$\frac{dx_w}{dt} = \frac{1}{M_t} [F_M^{\text{in}} x_w^{\text{in}} - F_M x_w + R_w] \quad (5.24)$$

where and  $F_M^{\text{in}}$   $F_M$  are inlet and outlet mass flow rates, respectively, and  $X_w^{\text{in}}$  is the moisture content in the feed solids.

In summary, the equations in the control relevant model for batch systems are discretized population balance equations given by Eq. 5.13, powder dynamics described by Eq. 5.21, and liquid dynamics represented by Eq. 5.23. The corresponding equations for continuous processes are Eqs. 5.14, 5.22 and 5.24. Both cases share the same kernel models given by Eqs. 5.18 and 5.19, and the growth-rate model described by Eq. 5.20.

**5.2.2.2. Objective Functions for System Optimization and Open-Loop Optimal Control.** The objective function for system optimization of batch granulation is:

$$\text{Minimize}_{S_d, B_d, x_w} \left\{ J = \frac{-w_1 M_p(t_f)}{t_f} \right\} \quad (5.25)$$

Subject to : Equation 5.13

The objective function for batch granulation with the binder spray rate as the only manipulative variable is given by:

$$\text{Minimize}_{R_w} \left\{ \frac{-w_1 M_p(t_f) + w_2 \int_0^{t_f} R_w dt}{t_f} \right\} \quad (5.26)$$

Subject to : Equations 5.13, 5.21, and 5.23

In Eqs. 5.25 and 5.26 ,  $M_p$  is the mass of product sized particles,  $w_1$  and  $w_2$  are weighting functions.

The objective function for steady-state optimization of continuous granulation is:

$$\begin{aligned} &\text{Minimize}_{S_d, B_d, F^m, R_w} \{ -w_1 F_p + w_2 R_w \} \\ &\text{Subject to :} \\ &\text{Equations 5.14, 5.22, 5.24 with left hand sides replaced by zero} \end{aligned} \quad (5.27)$$

where  $F_p$  is the mass flow rate of product sized particles.

For the state-driving study, we carry out steady-state optimizations for two different product specifications: the product range for steady state 1 (SS1) is 2.0–3.2 mm, whereas that for steady state 2 (SS2) is 3.2–5.0 mm. The objective function for this optimal state-driving problem is described as:

$$\text{Minimize}_{R_w} \left\{ J = \sum [w_{1,i} (M_i(t_f) - M_i^{SS2})^2] + w_2 \int_0^{t_f} R_w dt + w_3 t_f \right\} \quad (5.28)$$

Subject to :

Equations 5.14, 5.22, 5.24 and zero derivatives at final time

where  $M_i(t_f)$  and  $M_i^{ss2}$  denote the mass of particles in the  $i$ th size interval at the final time and for steady state 2, respectively.

### 5.2.3. Dynamic Optimization Algorithm

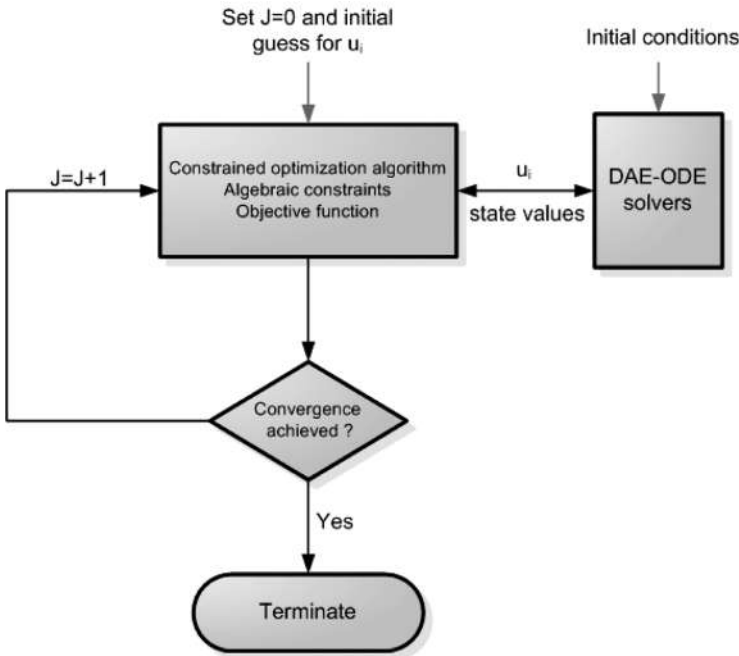
It is not difficult to solve the steady-state optimization problems with constraints represented by algebraic equations by using commercial software packages. We mainly explain the dynamic optimization methods used in this work. The basic structure of the algorithm employed in this paper is shown in [Figure 10](#).

In the dynamic optimization algorithm depicted in [Figure 10](#), a control parameterization technique (44) is used to discretize the originally continuous control variables. That is, a control (manipulative) variable  $u(t)$  is represented by a set of piece-wise constants,  $u_i$ ,  $i = 1, 2, \dots, q$ . These constants are treated as parameters to be determined by using dynamic optimization algorithms.

As the MATLAB software packages with Optimisation Toolbox provides both effective ordinary differential equation (ODE) solvers as well as powerful optimization algorithms, the dynamic simulations reported in this paper are carried out by using the MATLAB Optimisation Toolbox (8).

### 5.2.4. Selected Simulation Results and Discussion

Simulations for both batch and continuous granulation processes are based on a pilot plant drum granulator with the following parameters: length = 2 m, diameter = 0.3 m, nominal hold up = 40 kg, rotation rate = 25–40 rpm, retention time



**Figure 10** Basic structure of the dynamic optimization algorithm.

range = 6–10 min. Other process parameters are available in a recent paper by the authors (48).

The simulated optimal profiles for the batch processes are shown in [Figure 11](#) (a–c) with two data sets with and without constraints on control action. The control constraints restrict lower and upper bounds on the control variables (lower bound = 0 kg/s, upper bound = 0.015 kg/s), as well as the gradient of the control actions ( $|dR_w/dt| \leq 0.0003 \text{ kg/s}^2$ ). It can be seen from [Figure 11d](#) that if the normal constraints on the control variable are replaced by a high upper bound of control variable (0.036 kg/s) as the only constraint, very high spray rates at the early operating stage with very short spray time leads to the minimum objective function given by Eq. 5.26. However, if the normal constraints are activated, the control variable moves smoothly rather than suddenly with the price of a longer operational time. The difference between final times in the two cases is about 104 seconds (283–179 s), which is quite significant. The results clearly have implications on equipment design and specifications that could allow the constraints to be moved out, thus approaching the best operating policy.

Through steady-state optimizations using the objective function described by Eq. 5.27, optimal binder spray rates for two different specifications on product size ranges are obtained. These are:  $R_w = 0.050 \text{ kg/s}$  for 2.0–3.2 mm as the product size range, and  $R_w = 0.075 \text{ kg/s}$  for 3.2–5.0 mm as the product size range. [Figures 12a](#) and [12b](#) show the profiles using an optimal control policy and a constant spray rate policy. The change of the cumulative mass between initial and final times under optimal control policy is shown in [Figure 12c](#). The control profiles are depicted in [Figure 12d](#). The optimal control policy leads to about 50% reduction on the objective function given by Eq. 5.28. The optimal spray policy can be stated as: “Gradually

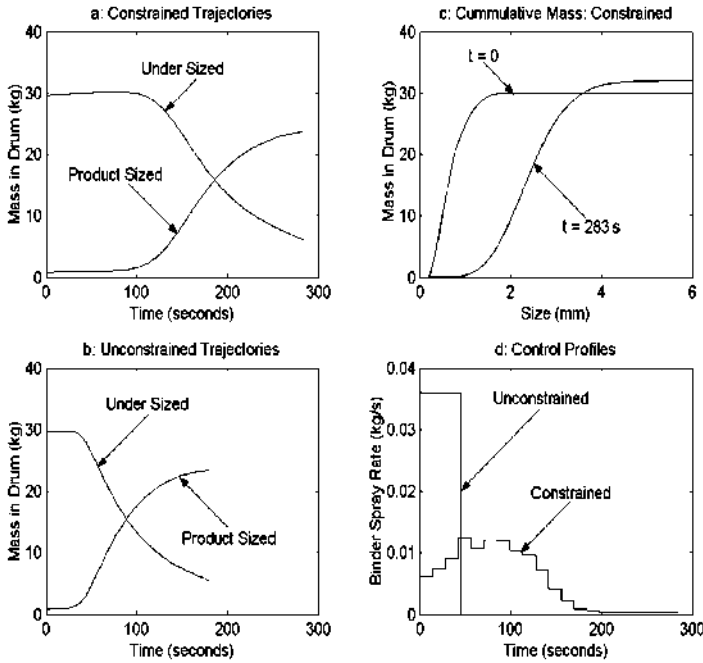


Figure 11 Optimal control of batch drum granulation.

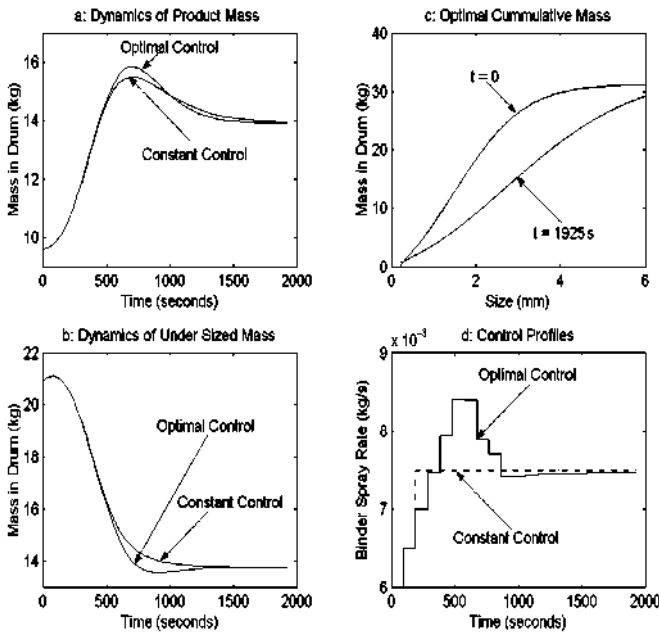
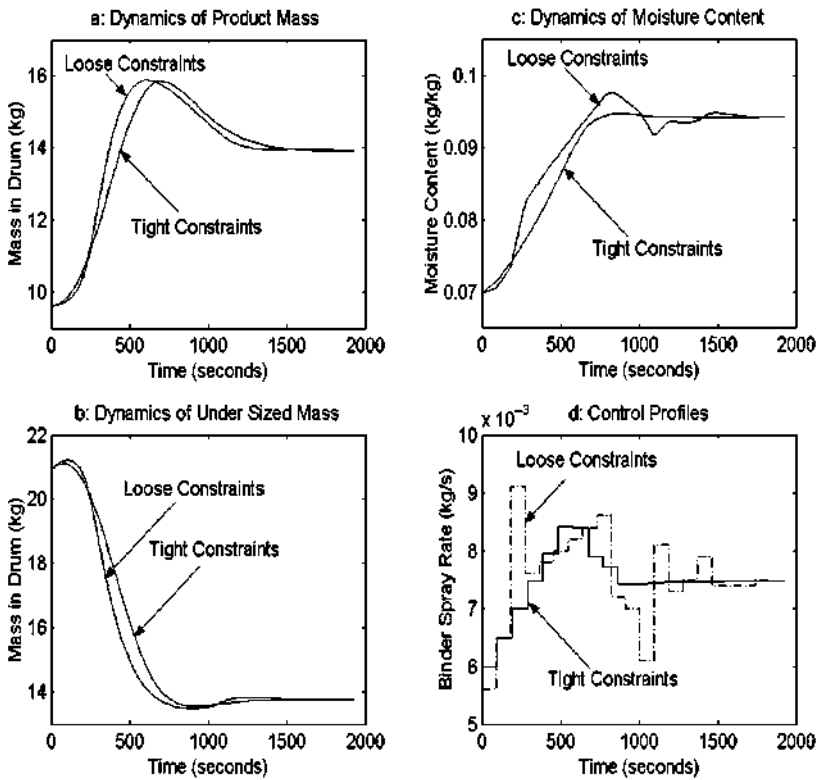


Figure 12 Optimal control of continuous drum granulation.



**Figure 13** Effects of constraint tightness on optimal control of drum granulation.

increase the spray rate from the first steady state (0.005 kg/s) to achieve a relatively high spray rate (0.0084 kg/s) followed by gradual reduction of the spray rate until the spray rate of the second steady-state value (0.0075 kg/s) is reached, which will be maintained for the rest of the operational period.” From Figure 12, the significance of optimal control studies can be demonstrated by observing the fact that the optimal profiles approach the second steady state faster, and the optimal control strategy is easy to implement with smooth movement. It should be pointed out that the small difference between two control policies shown in Figure 12 is because of the small difference between two product specifications (product ranges from 2.0–3.2 mm to 3.2–5.0). It can be predicted that if the two steady states are far away, profound economic benefit can be achieved. Optimal control strategies are particularly important to plant start up and shut down operations.

Figure 13 shows the dynamic profiles of optimal state driving from steady state 1 to steady state 2 with different levels of constraints. Dynamic changes of product mass, undersized mass, and moisture content are shown in Figure 13 a, b, and c, respectively, under two constraint levels. Figure 13d depicts control profiles for these two cases. In addition to the constraints on control actions, the final time constraints to ensure the final steady-state status is imposed on the system. That is, the left-hand side of Eqs 5.14, 5.22, and 5.24 should be zero at the final time. However, it is not necessary to achieve zero exactly for the derivatives at the final time. We normally impose the final time constraints as  $|dx(t_f)/dt| < \varepsilon$  in which  $x$  represents general state variables such as the number of particles, mass of powder, and moisture



content; and  $\varepsilon$  is a very small positive number for practical applications with the value depending on the tightness of constraints. The  $\varepsilon$  values are chosen as  $10^{-6}$  and  $10^{-3}$  for tight and loose constraints indicated in Figure 13, respectively. It can be shown from Figure 13 that the control strategy with loose constraints leads to shorter operational time than that with tight constraints (1827 vs. 1925s). However, the moisture dynamics shows severe offset and oscillation. In optimization simulations, only final time constraints are changed for the two cases. It is interesting to note that the program with tight constraints leads to small and smooth controller movements even though the constraints on the control variable are not altered explicitly. It seems that the loose constraints allow too much manipulative variation that drives the system into a region ( $X_w \approx 0.1$ ) where moisture variations have significant impact on the granulation performance. A marginal benefit identified by 5% time reduction is achievable using loose constraints with a price of process oscillations. Consequently, control strategy with tight final time constraints is superior to that with loose constraints in this particular application.

Through an analysis on the simulation results, the following conclusions can be drawn.

1. Population balance modeling provides an important basis for optimal design and operations for both batch and continuous granulation processes.
2. The effects of liquid content, bed depth, and drum rotation rate on the coalescence behavior can be quantified through the development of new kernel models with the structure described by Eqs 5.18 and 5.19. The simulation results are qualitatively consistent with industrial experience in large-scale fertilizer production.
3. An optimal control strategy and algorithm using commercial optimization software packages connected to reliable DAE/ODE solvers are successful for the determination of optimal trajectories with good convergence properties. This implies that under certain conditions, the more complicated optimal control algorithms, such as that based on the well-known Pontryagin's maximum principle, could be avoided.
4. As start-up and shutdown operations are frequently encountered in granulation plants with huge financial impacts, studies on optimal control strategies can lead to significant economic benefits.

## 6. CONCLUSION

Granulation modeling is an area of growing importance. It is dominated by the population balance approach for developing mechanistic models. However, it requires an improved understanding of the key factors involved in particle growth and breakage. This is currently improving. The growing importance of particulate flow patterns is being addressed through approaches such as discrete element methods (DEM), which will hopefully provide a microscale view of particle motions in the granulation device. The challenge is in addressing the multiscale nature of granulation modeling that spans from particle interactions up to the plant level.

The development of empirically based models has provided a simple means of addressing quickly a number of control-related applications. This will continue to be a useful approach for such problems.

Application of models to design, advanced control, and diagnosis will require mechanistic models that continue to incorporate the latest understanding of the underlying mechanisms. Much work is currently underway in these areas and the incorporation into existing models of new knowledge will help extend the applicability of process models for granulation.

## REFERENCES

1. Adetayo AA, Litster JD, Pratsinis SE, Ennis BJ. Population balance modelling of drum granulation of materials with wide size distribution. *Powder Technol* 1995; 82:37–49.
2. Adetayo AA, Ennis BJ. A unifying approach to modelling granulation processes coalescence mechanisms. *AIChE J* 1997; 43(1):927–934.
3. Adetayo AA, Pottman M, Ogunnaiké B. Effective control of a continuous granulation process, *Proc. Control of Particulate Processes IV*, 23–28, Engineering Foundation, NY, 1997.
4. Adetayo AA, Ennis BJ. A new approach to modelling granulation processes for simulation and control purposes. 2000; 108:202–209.
5. Balliu N. An object oriented approach to the modelling and dynamics of granulation circuits, PhD Thesis, School of Engineering, The University of Queensland, Australia 2004.
6. Bertoluzza S. A wavelet collocation method for the numerical solution of partial differential equations. *Appl Comput Harmonic Anal* 1996; 3:1–9.
7. Biggs CA, Sanders C, Scott AC, Willemsse AW, Hoffman AC, Instone T, Salman AD, Hounslow MJ. Coupling granule properties and granulation rates in high-shear granulation. *Powder Technol* 2003; 130:162–168.
8. Branch MA, Grace A. *MATLAB Optimization Toolbox User's Guide*, The Math Works Inc., Natick, 1996.
9. Cameron IT. Solution of Differential–Algebraic Systems using Diagonally Implicit Runge-Kutta Methods. *IMA J of Numerical Analysis* 1983; 3:273–289.
10. Crowley TJ, Meadows ES, Kostoulas A, Doyle III FJ. Control of particle size distribution described by a population balance model of semi-batch emulsion polymerisation. *J Process Control* 2000; 10:419–432.
11. Ennis BJ, Litster JD. Size enlargement, in *Perry's Chemical Engineering Handbook*, 7th Ed., Chapter 8. McGraw-Hill, NY, 1997.
12. Faure A, York P, Rowe RC. Process control and scale-up of pharmaceutical wet granulation processes: a review. *European J Pharm Biopharm* 2001; 52:269–277.
13. Friedlander SK, *Smoke, Dust and Haze*, 1<sup>st</sup> Ed., Wiley, NY, 1977; 2<sup>nd</sup> Ed., Oxford University Press, NY, 2000.
14. Golovin AM. *Sov. Phys. Dokl* 1963; 8:191.
15. Hangos KM, Cameron IT. *Process Modelling and Model Analysis*, Academic Press, London, ISBN 0–12–156931–4, 2001.
16. Hounslow MJ, Ryall RL, Marshall VR. A discrete population balance for nucleation, growth and aggregation. *AIChE J* 1998; 34(11):1821–1832.
17. Immanuel CD, Cordeiro CF, Meadows ES, Crowley TJ, Doyle FJ. Modelling of particle size distribution in immulsion co-polymerisation: Comparison with experimental data and parametric sensitivity studies. *Computers & Chemical Engineering* 2002; 26:1133–1152.
18. Kapur PC, Fuerstenau DW. Coalescence model for granulation. *Ind Eng Chem Pro Des Dev.* 1969; 8:56–62.
19. Kapur PC. Kinetics of granulation by non-random coalescence mechanism, *Chem Eng Sci* 1972; 27:1863–1869.
20. Kaye BH, *Powder Mixing*, Chapman & Hall, London, 1997.
21. Kristensen HG, Schaefer T. Granulation: A review on pharmaceutical wet granulation. *Drug Dev Ind Pharm* 1987; 13:803–872.

22. Kumar S, Ramkrishna D. On the solution of population balance equations by discretization – I: A fixed pivot technique. *Chem Eng Sci* 1996; 51(8):1311–1332.
23. Leuenberger H. Moist agglomeration of pharmaceutical processes. In: Chulia D, Deleuil M, Pourcelot Y, Eds. *Powder Technology and Pharmaceutical Processes, Handbook of Powder Technology*. Elsevier: Amsterdam, 1994 9:337–389.
24. Litster JD. Scale-up of wet granulation processes: science not art, *Powder Technol*, 2003; 130:5–40.
25. Liu LX, Litster JD, Iveson SM, Ennis BJ. Coalescence of deformable granules in wet granulation processes. *AIChE J* 2000; 46(3):529–539.
26. Liu LX, Litster JD. Population balance modelling of granulation with a physically based coalescence kernel, *Chem Eng Sci* 2002; 57:2183–2191.
27. Liu Y, Cameron IT, Wang FY. The wavelet collocation method for transient problems with steep gradients. *Chem Eng Sci* 2000; 55:1729–1734.
28. Liu Y, Cameron IT. A new wavelet-based method for the solution of the population balance equation. *Chem Eng Sci* 2001; 56:5283–5294.
29. Liu Y, Cameron IT. A new wavelet-based adaptive method for solving population balance equations. *Powder Technol* 2003; 130:181–188.
30. Ljung L. *System Identification: Theory for the user*. Prentice Hall, NJ: Upper Saddle River, 1987.
31. Ljung L. *System Identification Toolbox for Use with MATLAB*. The Math Works, Natick, MA, 2000.
32. Michaels JN. Toward rational design of powder processes. *Powder Technol* 2003; 138: 1–6.
- 32a. Miller SM, Rawlings JP. Model identification and control strategies for batch cooling crystallisers. *AIChE J* 1994; 40(8):1312–1326.
33. Mort PR, Capeci SW, Holder JW. Control of agglomerate attributes in a continuous binder-agglomeration process. *Powder Technol* 2001; 117:173–176.
34. Petzold L. A description of DASSL: A differential-algebraic system solver, *Proc. IMACS World Congress*, Montreal, Canada, 1982.
35. Ramkrishna D. *Population Balances: Theory and Applications to Particulate Systems in Engineering*. San Diego: Academic Press, 2000.
36. Randolph AD, Larson MA. *Theory of Particulate Processes: Analysis and Techniques of Continuous Crystallization*, 2<sup>nd</sup> Ed., Academic Press, San Diego 1988.
37. Robertson GA, Cameron IT. "Analysis of Dynamic Process Models for Structural Insight and Model Reduction—Part 1. Structural Identification Measures". *Computers & Chemical Engineering* 1997; 21(5):455–473.
38. Salman AD, Fu J, Gorham DA, Hounslow MJ. Impact breakage of fertilizer granules. *Powder Technol* 2002; 130:359–236.
39. Sanders CFW, Willemse AW, Salman AD, Hounslow MJ. Development of a predictive high-shear granulation model. *Powder Technology* 2003; 138:18–24.
40. Sastry KVS. Similarity size distribution of agglomerates during their growth by coalescence in granulation or green pelletization. *Int J Mineral Process* 1975; 2:187–203.
41. Smith M, Matsoukas T. Constant number Monte Carlo simulation of population balances. *Chem Eng Sci* 1998; 53(9):1777–1786.
42. Spielman LA, Levenspiel O. A Monte Carlo treatment for reaction and coalescing dispersed systems. *Chem Eng Sci* 1965; 20:247.
43. Tardos GI, Khan MI, Mort PR. Critical parameters and limiting condition in binder granulation of fine powders. *Powder Technol* 1997; 94:245–258.
44. Teo KL, Goh CJ, Wong KH. *A Unified Computational Approach for Optimal Control Problems*. Longman Scientific and Technical, New York, 1991.
45. van den Dries K, de Vegt O, Girard V, Vromans H. Granulae breakage phenomena in a high shear mixer: influence of process and formulation variables and consequences on granule homogeneity. *Powder Technol* 2003; 130:228–236.

46. Wang FY, Cameron IT. Review and future directions in the modelling and control of continuous drum granulation. *Powder Technol* 2002; 124:238–253.
47. Wang FY, Ge XY, Balliu N, Cameron IT. Optimal control and operation of drum granulation, Proc. 2nd International Conference on Population Balance Modelling (PBM 2004). Valencia, Spain, May 2004.
48. Wang FY, Ge XY, Balliu N, Cameron IT, Optimal control and operation of drum granulation. *Chem Engi Sci* In press (2005).
49. Wang FY, Cameron IT. Multi-level optimal control of particulate process with on-line identification, to be presented at The 7<sup>th</sup> World Congress of Chemical Engineering (WCCE 7), Glasgow, Scotland 10–14 July (2005).
50. Watano S, Numa T, Koizumi I, Osako Y. Feedback control in high shear granulation of pharmaceutical powders. *Eur J Pharm Biopharma* 2001a; 52:337–345.
51. Watano S, Numa T, Miyanami K, Osako Y. A fuzzy control system of high shear granulation using image processing. *Powder Technol* 2001b; 115:124–130.
52. Wauters PAL. Modelling and Mechanisms of Granulation, PhD thesis, The Delft University of Technology The Netherlands, 2001.
53. Williams R, Burrage RK, Cameron IT, Kerr M. A four-stage index 2 diagonally implicit Runge-Kutta method. *Applied Numerical Mathematics* 2002; 40:415–432.
54. Yekeler M, Ozkan A. Determination of the breakage and wetting parameters of calcite and their correlations. *Part Part Syst Charact* 2002; 19:419–425.
55. Zhang J, Lister JD, Wang FY, Cameron IT. Evaluation of control strategies for fertiliser granulation circuits using dynamic simulation. *Powder Technol* 2000; 108:122–129.

# 22

## Regulatory Issues in Granulation

**Prasad Kanneganti**

*Quality Operations, Pfizer Global Manufacturing, Pfizer Asia Pacific Pte. Ltd., Singapore*

### 1. INTRODUCTION

The pharmaceutical industry is one of the most regulated consumer industries today. Concerned with the safety of its citizens, governments across the world have set up regulations that govern the manufacturing and distribution of finished pharmaceuticals for human consumption. Like the industry, the regulations are also evolving to meet current business needs and future technological challenges. With the widespread use of the Internet, consumers have become better informed about drugs, therapies, and health risks. Current Good Manufacturing Practices (cGMPs) that were initially well established within the pharmaceutical industry in USA are now widely used across the globe. Globalization of the pharmaceutical industry has taken place rapidly in recent times fueled by mergers and acquisitions within the industry and also by economic, political, and regulatory factors. Harmonization initiatives seeking to develop common regulatory standards have become increasingly relevant and necessary.

### 2. PHARMACEUTICAL QUALITY MANAGEMENT

Quality management is that aspect of management function that establishes and implements the quality policy formally authorized by senior management. The fundamental elements of quality management are an appropriate infrastructure or quality system and systematic actions known as quality assurance taken to ensure adequate confidence that the product or service will satisfy established requirements for quality. Thus, quality assurance is a management tool covering all matters that individually or collectively influence the quality of a product. It incorporates cGMP as well as other factors such as product design and development. Quality control is a subset of cGMP and is concerned mainly with sampling, specifications, and testing of raw materials and finished pharmaceutical products. The concepts of quality assurance, cGMP, and quality control are thus interrelated aspects of quality management.

#### 2.1. Current Good Manufacturing Practices

cGMP is that part of the quality assurance system which ensures that medicinal products are consistently produced and controlled to the quality standards appropriate

to their intended use and as required by the marketing authorization provided by the regulatory agencies. The production of pharmaceutical products involves some risks, e.g., cross-contamination, label mix-ups, etc., that cannot be prevented entirely through end product testing and cGMPs diminish such risks. This quality assurance element is mandated by law around the world for the manufacturing, storage, and distribution of pharmaceuticals. Although the standards set by the United States Food and Drug Administration (FDA) (1,2) are well recognized as an industry benchmark, standards from other countries and regions are also gaining global recognition (3,4).

One of the cGMP standards that is gaining worldwide recognition is that set up by the Pharmaceutical Inspection Convention (PIC) and the Pharmaceutical Inspection Co-operation Scheme (PIC Scheme) commonly known as PIC/S. The purpose of PIC/S is to facilitate the networking between participating authorities and the maintenance of mutual confidence, the exchange of information and experience in the field of GMP and related areas, and the mutual training of GMP inspectors (5). PIC/S became operational in November 1995 when the PIC Scheme commenced operating in conjunction with PIC, which had already been operating since 1970.

The need to form the PIC Scheme became necessary when it was realized that an incompatibility between PIC and European law did not permit individual EU countries that were members of PIC to sign agreements with other countries seeking to join PIC. Only the European Commission was permitted to sign agreements with countries outside Europe, and the Commission itself was not a member of PIC. Therefore, a less formal and more flexible cooperation scheme was developed to continue and enhance the work of PIC. Unlike PIC, which is a legal treaty between countries, the PIC Scheme is a cooperative arrangement between Health authorities.

## 2.2. International Conference on Harmonization

The International Conference on Harmonization (ICH) of technical requirements for registration of pharmaceuticals for human use is a project that brings together the regulatory authorities of Europe, Japan, and the United States and experts from the pharmaceutical industry in these regions to discuss the scientific and technical aspects of product registration. With its secretariat in Geneva, Switzerland, ICH aims to achieve greater harmonization in the interpretation and application of technical guidelines and product registration requirements thus avoiding unnecessary duplication of testing carried out during the R&D phase for new medicines (6).

Guidelines issued by ICH are very useful reference documents for both industry and regulatory bodies. The topics for these guidelines are divided into four major categories, each with a specific topic code:

- Quality Topics (Q), e.g., Stability Testing (Q1), Impurity Testing (Q3)
- Safety Topics (S), e.g., Carcinogenicity Testing (S1), Genotoxicity Testing (S2)
- Efficacy Topics (E), e.g., Dose Response Studies (E4), Good Clinical Practices (E6)
- Multidisciplinary Topics (M), e.g., Medical Terminology (M1), The Common Technical Document (M4).

There is no specific ICH guideline for granulation; however, guidelines such as the Common Technical Document (CTD) highlight the requirements for specifications, testing, impurities, stability, and validation in drug product regulatory

submissions. In view of the wide international acceptance of these guidelines, it would be prudent to check compliance with requirements specified in them while putting together documentation dossiers to support regulatory filings or technology transfers.

### 2.3. ISO 9000 Standards

The International Organization for Standardization (ISO) is the world's largest developer of standards. ISO's principal activity is the development of technical standards. These are very useful to the industry, regulatory bodies, trade officials, suppliers and customers of products and services. With its Central Secretariat in Geneva, Switzerland, ISO coordinates a network of the national standards institutes of 148 countries (7). Each country is represented by one member that, unlike in the case of the United Nations, need not be a delegation of the national government.

ISO has gained wide acceptance internationally as a commonly understood baseline for quality, safety, and environment standards. It ensures fair play and facilitates cross-border trade. ISO standards are voluntary and being a nongovernmental organization, it has no legal authority to enforce their implementation. This is an essential difference with cGMPs that have been legislated into law in several countries.

One of the most popular standards is ISO 9000, which is a generic management system standard that has become an international reference for quality requirements in business-to-business dealings. The latest standard is the ISO 9000: 2000 series, which was launched on December 15, 2000, and constitutes the most thorough overhaul of this standard since it was first published in 1987. Businesses complying with the older standards of ISO 9001 through 9003 were provided 3 years to make the transition to the new version. ISO 9000: 2000 takes into account the developments in the field of quality management and introduces eight quality management principles on which the quality management system standards are based. Senior management can use these principles as a framework to guide their organizations toward improved performance. The eight principles are customer focus, leadership, involvement of people, process approach, system approach to management, continual improvement, factual approach to decision making, and mutually beneficial supplier relationship.

Several ingredients in a drug product formulation may be common chemicals also used in the food and cosmetic industries. For manufacturers of such chemicals, if cGMP is not mandated by law, compliance with ISO 9000 is generally expected by pharmaceutical manufacturers as part of their supplier management program.

## 3. POSTAPPROVAL CHANGE CONSIDERATIONS

Scale-up of manufacturing is required during transfer of production processes from drug product development laboratories to commercial manufacturing centers or between manufacturing centers. Much of the industry is undergoing mergers and acquisitions that is leading to the globalization of manufacturing and supply chain. To make manufacturing processes efficient, companies are grouping key products into regional manufacturing centers. In the past, global trade was hindered by regulatory and importation barriers. With the recent success of global initiatives to improve trade, such barriers are eroding away, giving way to large-scale global manufacturing facilities.

During the manufacture of clinical batches, the amount of active ingredient available is limited and the process equipment available are often scaled-down versions of those used for the production of commercial batches. Batch sizes, thus, are smaller than those used during the manufacture of routine commercial batches. Process scale-up and commercial manufacturing are expedited as the industry attempts to maximize the commercial benefits afforded by patent protection for new drug molecules. Most companies formally record the scientific data that are generated into product development reports. These form the basis for establishing the manufacturing process, specifications, in-process controls, and validation acceptance criteria used during commercial production of the drug product. Product development reports also provide a link between the biobatch/clinical batch and commercial process through development and scale-up. Information from the development phase is used to prepare the chemistry, manufacturing, and controls (CMC) section of an application such as a new drug application (NDA) filed with the FDA (8). Where applicable, reference is also provided to other documents such as drug master files (DMFs) submitted earlier to the FDA by the manufacturer or their vendors (9).

The FDA with input from the industry developed guidance for scale-up and postapproval changes (SUPAC) for drug products. SUPAC covers components or composition, site of manufacture, scale of manufacture, and manufacturing process/equipment. These guidelines represent the agency's current thinking on the topic and are not binding on the industry or agency, with alternative approaches being acceptable. The guidance documents have been found by the pharmaceutical industry to enhance its ability to plan and implement change and manage resources efficiently.

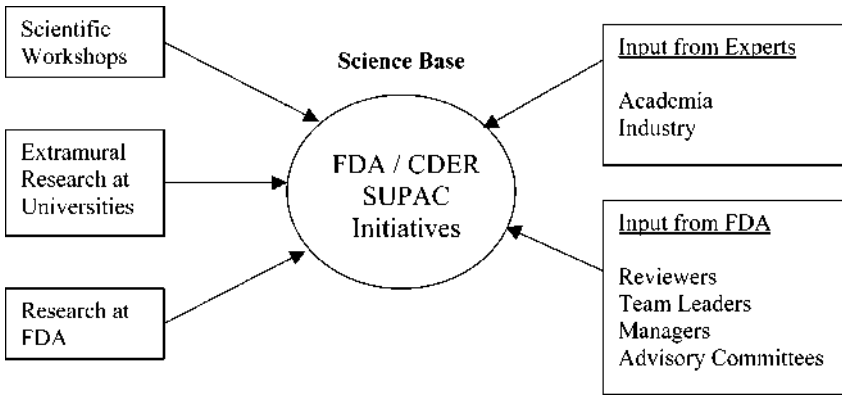
The SUPAC-IR guidance for immediate release solid oral dosage forms (10) provides recommendations to sponsors of NDAs, abbreviated new drug applications (ANDAs), and abbreviated antibiotic applications (AADAs) who intend, during the postapproval period, to make changes. This guidance was the result of a workshop on the scale-up of immediate release products conducted by the American Association of Pharmaceutical Scientists (AAPS) in conjunction with the United States Pharmacopoeial Convention (USP) and the FDA (11). It defines the levels of change, recommended CMC tests for each level of change, in vitro dissolution tests, and in vivo bioequivalence tests for each level of change and filing documentation that should support the change (Figures 1 and 2).

Notification to FDA of postapproval changes to NDAs are made using change documentation known as supplements (12). The regulations describe the type of changes that require prior approval from the FDA before the change can be implemented (preapprovable changes). Under some circumstances, changes can be made before approval from FDA [changes being effected (CBEs)] or described in the annual report to the FDA. In the case of CBE supplements, the FDA may, after a review of the information submitted, decide that the changes are not approvable. The SUPAC guidance documents list information that should be provided to the FDA to ensure that product quality and the performance characteristics of the drug products are not adversely affected by the changes proposed to be carried out.

### 3.1. Component and Composition Changes

The SUPAC guidance focuses on changes in excipients in the drug product. Changes in the amount of drug substance are not addressed by this guidance. The changes are





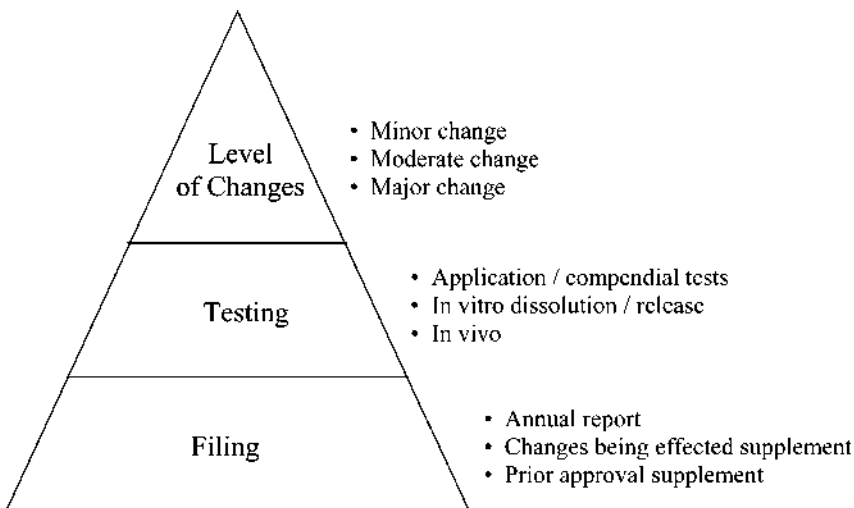
**Figure 1** Development of SUPAC guidance documents.

categorized into three levels according to the increasing impact on product quality and performance expected.

3.1.1. *Level 1 Changes*

Level 1 changes are those that are unlikely to have any detectable impact on formulation quality and performance. Examples of such changes are deletion or partial deletion of an ingredient intended to affect the color or flavor of the drug product, changes in the composition of the printing ink to another approved ingredient, etc. Changes in excipients, expressed as percentages (w/w) of total formulation, less than or equal to the percent ranges shown in [Table 1](#) are also Level 1 changes. The total additive effect of all excipients changes should not be more than 5%.

The documentation necessary to support this type of change are application/compendial release requirements and stability data for one batch on long-term stability. No in vivo bioequivalence data or additional dissolution data other than those



**Figure 2** Format of SUPAC guidance documents.

**Table 1** SUPAC-IR: Component or Composition Change Levels

Excipient	% Excipient (w/w of total dosage unit)		
	Level 1	Level 2	Level 3
Filler	±5	±10	> 10
Disintegrant			
Starch	±3	±6	> 6
Other	±1	±2	> 2
Binder	±0.5	±1	> 1
Lubricant			
Ca or Mg stearate	±0.25	±0.5	> 0.5
Other	±1	±2	> 2
Glidant			
Talc	±1	±2	> 2
Other	±0.1	±0.2	> 0.2
Film coat	±1	±2	> 2
Total drug excipient change (%)	5	10	N/A

Source: From Ref. 10.

required by the application/compendia are necessary for this submission. The entire documentation package including long-term stability data for the Level 1 change is filed with the FDA through the annual report mechanism.

### 3.1.2. Level 2 Changes

Level 2 changes are those that could have a significant impact on formulation quality and performance. The testing and filing requirements for Level 2 changes vary depending on three factors—therapeutic range, solubility, and permeability. Therapeutic ranges are defined as narrow or non-narrow and drug solubility and drug permeability are defined as either low or high. A list of narrow therapeutic range drugs is provided in the guidance document. Solubility is calculated based on the minimum concentration of drug, milligram/milliliter (mg/mL), in the largest dosage strength, determined in the physiological pH range (pH 1–8) and temperature ( $37 \pm 0.5^\circ\text{C}$ ). Permeability ( $P_e$ , cm/sec) is defined as the effective human jejunal wall permeability of a drug and includes an apparent resistance to mass transport to the intestinal membrane.

An example of a Level 2 change is change in the technical grade of an excipient, e.g., Avicel PH102 vs. Avicel PH200. Changes in excipients, expressed as a percentage (w/w) of the total formulation, greater than those listed earlier for Level 1 changes but less than or equal to a percent range representing a twofold increase over Level 1 changes (Table 1) are also deemed as Level 2 changes. The total additive effect of all excipients changes should not be more than 10%.

The documentation necessary to support this type of change are application/compendial release requirements, batch records, and stability data for one batch with 3 months' accelerated stability data in supplement and one batch on long-term stability. Dissolution data requirements depend on three scenarios known as cases that cover a high/low permeability and a high/low drug solubility, as shown in Table 2. No in vivo bioequivalence data are necessary for this submission if the

**Table 2** SUPAC-IR: Dissolution Testing Categories

Category	Nature of drug	Dissolution medium	Time points (min)	Specification
Case A	High permeability, high solubility	0.1 N HCl	15	≥85%
Case B	Low permeability, high solubility	As stated in application/ compendia	15, 30, 45, 60, 120, or until asymptote is reached	Dissolution profile similar to current formulation
Case C	High permeability, low solubility	Water, 0.1 N HCl, USP buffer media at pH 4.5, 6.5, and 7.5 (plus surfactant if justified)	15, 30, 45, 60, 120	90% or asymptote is reached; profile similar to current product

Source: From Ref. 10.

situation falls within one of the cases shown in Table 2. A prior approval supplement that contains all information including accelerated stability data is to be filed. The long-term stability data are filed through the annual report mechanism.

### 3.1.3. Level 3 Changes

Level 3 changes are those that are likely to have a significant impact on formulation quality and performance. Similar to Level 2 changes, the testing and filing documentation requirements vary depending on therapeutic range, solubility, and permeability. Examples of Level 3 changes are any qualitative and quantitative excipients change to a narrow therapeutic drug beyond the ranges stated for Level 1 changes (Table 1) and all drugs not meeting the dissolution criteria listed for Level 2 changes (Table 2).

A change in granulating solution volume is not covered under SUPAC-IR as it is a minor change to a normal operating procedure and should be included in the batch record after undergoing validation and manufacturer's site change control procedure. A change in the granulating solvent, e.g., from alcohol to water, can be expected to alter the composition of the drug product even though it may be removed during manufacturing and hence it is a Level 3 change that requires a prior approval supplement.

The documentation required to support Level 3 changes are application/ compendial release requirements and batch records. If a significant body of information is available, one batch with 3 months' accelerated stability data is to be included in the supplement and one batch on long-term stability data reported in the annual report. Where a significant body of information is not available, up to three batches with 3 months' accelerated stability data are to be included in the supplement and one batch on long-term stability data reported in the annual report.

Dissolution data requirements for Level 3 changes are as specified for Case B in Table 2. In addition, a complete *in vivo* bioequivalence study is required. This study may be waived if an acceptable *in vivo*/*in vitro* correlation has been verified. A prior approval supplement that contains all information including accelerated stability data is to be filed.

### 3.2. Site Changes

Site changes consist of changes in location of the site of manufacture for both company-owned and contract manufacturing facilities. These do not include any scale-up changes, changes in manufacturing process or equipment, or changes in components or composition. The new manufacturing locations are expected to have a satisfactory cGMP inspection. Similar to those for component and composition changes, site changes are also categorized into three different levels that require differing depth of test and filing documentation. Level 1 changes are site changes within a single facility while Level 2 changes are site changes within the same campus. Level 3 changes consist of a change in manufacturing site to a different campus, i.e., the facilities are not on the same original contiguous site or in adjacent city blocks. These requirements are summarized in [Table 3](#).

### 3.3. Changes in Batch Size

Postapproval changes in the size of a batch (scale-up/scale-down) from the pivotal/pilot scale biobatch material to a larger or smaller production batch require additional information to be submitted with the change application. Scale-down below 100,000 dosage units is not covered by the SUPAC guidance. All scale-up changes are required to undergo suitable process validation and regulatory inspection. There are two levels of batch size changes that cover batch size increases up to and including a factor of 10 times the size of the pilot/biobatch and increases beyond a factor of 10 times, respectively (Table 3).

### 3.4. Manufacturing Equipment/Process Changes

Equipment changes consist of changes from nonautomated or nonmechanical equipment to automated or mechanical equipment or changes to alternative equipment either of the same or different design and operating principles or of a different capacity. Process changes include changes such as mixing time and operating speeds either within or outside application/validation ranges. A change in the process used in the manufacture of the drug product, e.g., change from wet granulation to direct compression is also included. Table 3 provides a summary of the documentation requirements to file changes to manufacturing equipment and process.

### 3.5. Modified Release Solid Dosage Form

Modified release solid dosage forms include both delayed and extended release drug products. Delayed release is the release of a drug (or drugs) at a time other than immediately following oral administration. Extended release products, on the other hand, are formulated to make the drug available over an extended period after ingestion so that a reduction in the dosing frequency compared to an immediate release dosage form is achieved.

Following the successful release of the guidance document for immediate release solid oral dosage forms (SUPAC-IR), the FDA issued a specific guidance, the SUPAC-MR, for scale-up and postapproval changes affecting modified release solid dosage forms (13,14) in 1997. This guidance covers postapproval changes for modified release solid oral dosage forms that affect components and composition, scale-up/scale-down, site change, and manufacturing process or equipment changes.

It permits less burdensome notice of certain postapproval changes within the meaning of 21CFR 314.70.

In the case of components and composition, SUPAC-MR covers changes in non-release controlling excipients and release controlling excipients separately. The criticality of excipients to drug release is to be established and appropriate justifications provided if an excipient is claimed as a non-release controlling excipient in the formulation of the modified release solid dosage form. The change level classification, therapeutic range, test and filing documentation for components and composition changes, site changes, changes in batch size (scale-up/scale-down), manufacturing equipment changes, and manufacturing process changes for extended release solid dosage forms and delayed release solid dosage forms are summarized in this guidance document.

### 3.6. Changes to Granulation Equipment

The FDA released in January 1999 another guidance document that specifically addressed documentation requirements for filings addressing changes to pharmaceutical manufacturing equipment (15). This is the manufacturing equipment addendum developed with the assistance of the International Society of Pharmaceutical Engineering (ISPE) and is used in conjunction with the SUPAC-IR and SUPAC-MR guidance documents. It includes a representative list of equipment commonly used in the industry but does not include equipment modified by a manufacturer to meet specific needs. Definitions and classification for broad categories of unit operations such as blending and mixing, drying, particle size reduction/separation, granulation, unit dosage, coating, printing, and soft gelatin encapsulation are provided. For each unit operation, a table categorizing process equipment by class (operating principle) and subclass (design characteristics) along with examples of commercially available equipment is presented.

Granulation is defined as the process of creating granules either by using a liquid that causes particles to bind through capillary forces or by dry compaction forces. Granulation is stated to impact on one or more of the powder properties such as enhanced flow; increased compressibility; densification; alteration of physical appearance to attain more spherical, uniform, or larger particles; and or enhanced hydrophilic surface properties.

The operating principles listed in the SUPAC manufacturing equipment addendum (15) are

1. *Dry granulation*: Dry powder densification and/or agglomeration by direct physical compaction.
2. *Wet high-shear granulation*: Powder densification and/or agglomeration by the incorporation of a granulation fluid into the powder with high-power-per-unit mass, through rotating high-shear forces.
3. *Wet low-shear granulation*: Powder densification and/or agglomeration by the incorporation of a granulation fluid into the powder with low-power-per-unit mass, through rotating low-shear forces.
4. *Low-shear tumble granulation*: Powder densification and/or agglomeration by the incorporation of a granulation fluid into the powder with low-power-per-unit mass, through rotation of the container vessel and/or intensifier bar.

**Table 3** SUPAC-IR: Site Equipment and Process Change Requirements by Category

Type/level	Change permitted	Exclusions	Documentation			
			Chemistry	Dissolution	Bioequivalence	Filing
<i>Component/composition</i>						
Level 1	Table 1: total change $\leq 5\%$	No change beyond approved target ranges	LTSS <sup>a</sup> commitment	Application/compendial only	None	Annual report
Level 2	Table 1: total change $\leq 10\%$	No narrow therapeutic range drugs	Accelerated stability data plus LTSS commitment	Varies (Table 2)	None	Prior approval supplement
Level 3	Table 1	None	Accelerated stability data plus LTSS commitment	Case B (Table 2)	Full	Prior approval supplement
<i>Site change</i>						
Level 1	Single facility	No scale or process changes	None	Application/compendial only	None	Annual report
Level 2	Contiguous campus	No scale or process changes	None	Application/compendial only	None	CBE supplement
Level 3	Different campus	No scale or process changes	Accelerated stability data and LTSS commitment	Case B (Table 2)	None	CBE supplement
<i>Scale-up/scale-down</i>						
Level 1	$\leq 10$ -fold increase in batch size	No change in site, controls, or equipment	LTSS commitment	Application/compendial only	None	Annual report
Level 2	$> 10$ -fold increase in batch size	No change in site, controls, or equipment	Accelerated stability data and LTSS commitment	Case B (Table 2)	None	CBE supplement

*Manufacturing equipment*

Level 1	Non-to-automated/ non-to-mechanical; new equipment design w/wo same capacity	No change in operating principle	LTSS commitment	Application/ compendial only	None	Annual report
Level 2	New design or operating principle	None	Accelerated stability data and LTSS commitment	Case C (Table 2)	None	Prior approval supplement with change justification

*Manufacturing process*

Level 1	Operating within validation ranges	None	None	Application/ compendial only	None	Annual report
Level 2	Operating outside validation ranges	None	LTSS commitment	Case B (Table 2)	None	CBE supplement
Level 3	New process (e.g., wet-to-dry granulation)	None	Accelerated stability data and LTSS commitment	Case B (Table 2)	Full	Prior approval supplement with change justification

<sup>a</sup>LTSS, long-term stability study.

Source: From Ref. 10.

5. *Extrusion granulation*: Plasticization of solids or wetted mass of solids and granulation fluid with linear shear through a sized orifice using a pressure gradient.
6. *Rotary granulation*: Spheronization, agglomeration, and/or densification of a wetted or nonwetted powder or extruded material. This is accomplished by centrifugal or rotational forces from a central rotating disk, rotating walls, or both. The process may include the incorporation and/or drying of a granulation fluid.
7. *Fluid bed granulation*: Powder densification and/or agglomeration with little or no shear by direct granulation fluid atomization and impingement on solids, while suspended by a controlled gas stream, with simultaneous drying.
8. *Spray dry granulation*: A pumpable granulating liquid containing solids (in solution or suspension) is atomized in a drying chamber and rapidly dried by a controlled gas stream, producing a dry powder.

The classification of granulation equipment in the SUPAC manufacturing equipment addendum (15) is as follows:

1. *Dry granulator*: Dry granulator subclasses primarily are distinguished by the densification force application mechanism:
  - Slugging
  - Roller compaction
2. *Wet high-shear granulator*: Wet high-shear granulator subclasses primarily are distinguished by the geometric positioning of the primary impellers; impellers can be top, bottom, or side driven.
  - Vertical (top or bottom driven)
  - Horizontal (side driven)
3. *Wet low-shear granulator*: Wet low-shear granulator subclasses primarily are distinguished by the geometry and design of the shear inducing components; shear can be induced by rotating impeller, reciprocal kneading action, or convection screw action.
  - Planetary
  - Kneading
  - Screw
4. *Low-shear tumble granulator*: Although low-shear tumble granulators may differ from one another in vessel geometry and type of dispersion or intensifier bar, no low-shear tumble granulator subclasses have been identified.
5. *Extrusion granulator*: Extrusion granulator subclasses primarily are distinguished by the orientation of extrusion surfaces and driving pressure production mechanism:
  - Radial or basket
  - Axial
  - Ram
  - Roller, gear, or pelletizer
6. *Rotary granulator*: Rotary granulator subclasses primarily are distinguished by their structural architecture. They have either open top architecture,



such as a vertical centrifugal spheronizer, or closed top architecture, such as a closed top fluid bed dryer:

- Open
  - Closed
7. *Fluid bed granulator*: Although fluid bed granulators may differ from one another in geometry, operating pressures, and other conditions, no fluid bed granulator subclasses have been identified.
  8. *Spray dry granulator*: Although spray dry granulators may differ from one another in geometry, operating pressures, and other conditions, no spray dry granulator subclasses have been identified.

Table 4 shows a listing of granulation equipment classes and subclasses. Equipment within the same class or subclass would be considered to have the same design and operating principle under SUPAC-IR and SUPAC-MR. As an example, a change from one type of wet high-shear granulator (e.g., vertical type from manufacturer A) to another type of wet high-shear granulator (e.g., vertical type from manufacturer B) generally would not represent a change in operating principle and would, therefore, be considered to be the same under either SUPAC-IR or SUPAC-MR.

A change from equipment in one class to equipment in a different class would usually be considered a change in design and operating principle. Thus, a change from a wet high-shear granulator to a fluid bed granulator demonstrates a change in the operating principle from powder densification by wet agglomeration using high shear to powder densification with little or no shear. Such a change would be considered to be different under either SUPAC-IR or SUPAC-MR.

The FDA advises change applicants to carefully consider and evaluate on a case-by-case basis changes in equipment that are in the same class, but different subclass. For example, a change from a horizontal (side driven) wet high-shear granulator to a vertical (top or bottom driven) wet high-shear granulator represents a change within a class and between subclasses. This change would not require a pre-approval supplement provided the manufacturing process with the new equipment is validated. The data and rationale used to make this determination can be reviewed by the FDA at its discretion. In the event a single piece of equipment is capable of performing multiple discrete unit operations, e.g., mixing, granulation, drying, etc., the unit is evaluated solely for its ability to granulate.

### 3.7. International Change Notification

The manufacturing process and equipment change notification outside the United States varies from region to region. A brief description of the manufacturing process is required as part of the filing requirements for marketing a drug product. Some countries require master batch records to be filed but most others do not require much detail. In addition, a site master file that provides information on the production and control of the manufacturing operations including major process equipment at the site is sometimes required (16).

Regulatory agencies in countries that form the European Community (EC) have adopted a common approach to the procedures for variations to the terms of a marketing authorization. Variations can be by notification such as Type IA and Type IB that are categorized as minor variations that fulfill the conditions set forth

**Table 4** Unit Operation—Granulation

Class	Subclass	Examples
Dry granulator	Slugging Roller compaction	Various Alexanderwerk Bepex (Hosokawa) Fitzpatrick Freund Vector
Wet high-shear granulator	Horizontal (side driven)  Vertical (top or bottom driven)	Littleford Day Lodige Processall Aeromatic-Fielder (GEA-Niro) APV Baker-Perkins L.B. Bohle Dierks & Shone Diosna (Fluid Air) GEI-Collette (GEI International) Key International Littleford Day Lodige Powrex (Glatt) Processall Werner & Pfeiderer Zanchetta (Romaco)
Wet low shear granulator	Planetary          Kneading	Aaron Aeschbach AMF GEI-Collette (GEI International) Hobart Jaygo Littleford Day Ross Vrieco Aaron Paul O. Abbe Custom Metal Craft Dynamic Air Jaygo Kemutec Littleford Day Processall Ross Sigma Teledyne Readco Vrieco-Nauta (Hosokawa)
Low-shear tumble granulator	Screw Slant cone, or double cone, or V-blender	Paul O. Abbe Gemco Patterson-Kelley
Extrusion granulator	Radial or basket	Alexanderwerk GEA Niro

*(Continued)*

**Table 4** Unit Operation—Granulation (*Continued*)

Class	Subclass	Examples
Rotary granulator	Axial	LCI
		Luwa
		Ross
		Bepex (Hosokawa)
		Gabler
	Ram	LCI
		LCI
	Roller, gear, or pelletizer	Alexanderwerk
		Bepex (Hosokawa)
	Open	Freund (Vector)
GEA Niro		
LCI		
Luwa		
Closed		Aeromatic-Fielder (GEA Niro)
	Glatt	
	LCI	
	Luwa	
	Fluid bed granulator	None identified
APV		
BWI Hüttlin (Thomas Engineering)		
Diosna		
Fitzpatrick		
Fluid Air		
Glatt		
Heinen		
Vector		
Spray dry granulator		
	GEA Niro	
	Glatt	
	Heinen	

Source: Ref. 15.

in an annex to the EC regulations (17). A major variation of Type II is a variation which cannot be deemed to be a minor variation or an extension of the marketing authorization and requires prior approval. A downscaling of batch size by 10 times or an increase that results in up to 10 times the original batch size approved at the grant of the marketing authorization is a Type IA change (18). All other batch size decreases/increases or minor changes in the manufacturing process for the finished product require a Type IB filing. A minor change to the manufacture is one where the overall manufacturing principle remains the same and the new process leads to an identical product regarding all aspects of quality, safety and efficacy.

#### 4. VALIDATION OF GRANULATION PROCESSES

Validation is defined by the FDA as establishing documented evidence which provides a high degree of assurance that a specific process will consistently produce a product meeting its predetermined specifications and quality attributes (19). Process

validation is required both in general and specific terms by cGMPs for finished pharmaceuticals—21 CFR Parts 210 and 211. The WHO defines validation as the collection and evaluation of data, beginning at the process development stage and continuing through the production phase, which ensure that the manufacturing processes, including equipment, buildings, personnel, and materials, are capable of achieving the intended results on a consistent and continuous basis (20).

For a manufacturing facility, process knowledge is provided through technology transfer dossiers. Granulation is a critical process step that has a direct impact on the quality of the drug product manufactured and hence requires validation. The overall validation activity at a manufacturing facility is detailed in a document known as the validation master plan (VMP). The validation of the granulation process is described in the VMP. Critical process parameters for granulation such as the rate and amount of granulation fluid added, impeller and chopper speed, and mixing time are identified and in-process controls such as moisture content and granulation end point measurement are established during the product development phase.

#### 4.1. Equipment/Utilities Qualification

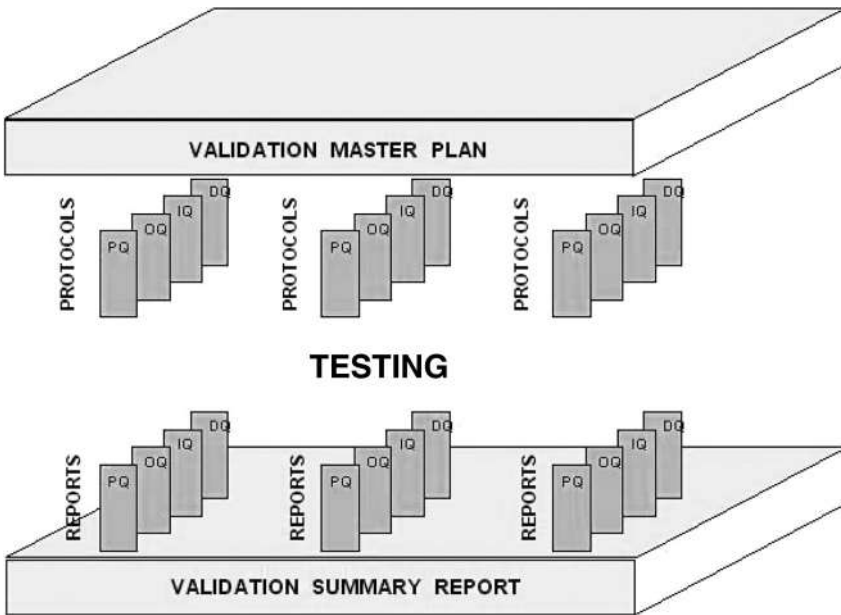
The qualification of the manufacturing equipment and control instrumentation is a prerequisite to the validation of the granulation process. Critical utilities such as purified water, compressed air, gaseous nitrogen, etc., required for granulation are also validated to ensure that they meet the required quality specification at the point of delivery to the granulation equipment.

The qualification of granulation equipment is carried out sequentially beginning with design qualification (DQ) followed by installation qualification (IQ) and operational qualification (OQ) (Fig. 3). The quality of process equipment depends on the effort put into its design and DQ provides evidence that quality is built into the design of the equipment. Quite often a design rationale instead of a DQ is prepared. This document addresses why a specific piece of equipment was chosen highlighting its quality and safety considerations and provides evidence of the assessment carried out to judge its suitability for the manufacturing of the drug product.

IQ provides documented evidence that the equipment is installed as designed and specified and correctly interfaced with other systems such as electrical supply and utilities. During this phase of qualification, equipment manuals/drawings, specifications, manufacturers test records, etc., together with installation documents and “as-built” drawings are compiled and verified. Calibration of instrumentation and maintenance checks are also established. OQ is a documented demonstration that the process equipment as installed operates well. At this stage, generally a manufacturing process simulation is carried out using a placebo formulation instead of the actual drug product recipe. For each qualification phase, a protocol detailing the activity and acceptance criteria is prepared. At the conclusion of the testing activity, a summary report that discusses the results and the readiness to proceed to the next phase of qualification is issued.

#### 4.2. Performance Qualification

Performance Qualification (PQ) is a documented program that demonstrates that the granulation process when carried out within defined parameters will consistently perform its intended function to meet its pre-established acceptance criteria. Thus, PQ is



**Figure 3** Documentation hierarchy for pharmaceutical process validation.

dynamic testing that combines the equipment, utilities, and manufacturing process to produce the product under routine operational conditions.

Product specifications that become the basis for the acceptance criteria at PQ stage are established during the development of the process with the biobatch or pivotal clinical batch serving as the reference batch. Prospective validation of the granulation process is generally carried out for new products and the data included in regulatory submissions, if necessary. The norm is to manufacture at least three consecutive PQ batches; however, a process capability study can establish the actual number of batches required based on the natural variability of a process (21). Revalidation may be required after changes that significantly impact product quality are made or on a periodic basis at scheduled intervals.

A FDA field inspection guide for validation of oral solid dosage forms lists granulation/mix analysis as a major area for investigation (22). It discusses various types of mixers and granulation equipment and highlights their design features as well as problems associated with their efficiency and validation. Blending validation and content uniformity failures due to poor mixing are of chief concern for most conventional mixers (Table 5). This guide also compares dryers and notes that the fluid bed dryer is superior to the oven dryer as it yields a more uniform granulation with spherical particles.

### 4.3. Computer Validation

Granulation equipment is supported by computer control systems that are getting increasingly sophisticated. Most commercial equipment has programmable logic controllers or embedded microprocessors. International forums with representation from users and the vendors of equipment and software have been set up to address the software life cycle documentation requirements. GAMP 4 is a globally accepted

guidance document developed by ISPE and the GAMP Forum to address computer validation (23). The PIC/S Guide to Good Practices for computerized systems in regulated “GXP” environments developed by international regulatory agencies is also a useful reference document for manufacturers and other users (24).

Electronic records and electronic signatures that have cGMP implications are generally expected by regulatory agencies to be equivalent to paper records and handwritten signatures executed on paper (25). A new guidance that represents FDA’s current thinking on electronic records and electronic signatures was released in August 2003 (26). The agency took a narrower interpretation of the requirements stated in 21 CFR Part 11 following feedback from the pharmaceutical industry and vendors that the regulations could stifle technological advances by restricting the use of electronic technology and increasing the cost of compliance. PIC/S also requires the regulated user to validate the system for storage of the information electronically for the required time and to ensure that the data are protected from damage or loss and can be easily retrieved in a legible form (24).

**Table 5** Typical Problems Associated with Mixing Equipment

Mixer Type	Design Feature	Limitations/problems
Planetary (pony pan)	Open pan/pot Horizontal blending	Dusty operation Cross-contamination problem Poor vertical mixing Segregation or nonmixing of components Difficult to validate
Ribbon blender	Top loading Horizontal and vertical blending Discharge valve Blade clearance	Moderately dusty operation Cross-contamination problem “Dead spot/zone” at the discharge valve Poor mixing at ends of the center horizontal mixing bar and shell wall Cleaning problems with seals/packing Risk of overflow leading to poor mixing
Tumble blender	Twin shell/double cone Mild mixing action	Mild mixing action Powder lumps will not break up Low humidity results in static charge buildup High humidity leads to lumping
High shear	High-energy chopper	Different mixing time compared to conventional mixers Drug substance may partially dissolve or recrystallize Charring due to heat generation Cleaning requires disassembly of chopper

Source: From Ref. 22.

## 5. CONCLUSION

The globalization of pharmaceutical manufacturing is proceeding rapidly, driven by mergers and acquisitions within the industry and the freeing up of cross-border trade. In addition to known global quality standards such as ISO 9000, harmonization of cGMPs and regulatory filing requirements is making progress driven by ICH and regional forums such as PIC/S. Simplification of existing regulations for notification of postapproval changes to regulatory filings has also been achieved through workshops representing regulatory bodies such as the FDA, the pharmaceutical industry, and academia. Such guidance has been found to be very useful by manufacturers as it gives them greater flexibility of operations, cost savings, and efficient management of resources. The manufacturer is however, expected to carry out a thorough scientific review to evaluate the impact of all changes on product quality and performance. Granulation is a critical process step and hence requires to be validated as part of the overall validation of the manufacturing process. Computer validation becomes increasingly relevant with the use of control systems in granulation equipment, electronic records, and electronic signatures. Process engineers and product development researchers today require a sound understanding of regulations governing drug product approval, validation, and change management.

## REFERENCES

1. 21 CFR Part 210. Current Good Manufacturing Practice in Manufacturing, Processing, Packing, or Holding of Drugs; General.
2. 21 CFR Part 211. Current Good Manufacturing Practice for Finished Pharmaceuticals.
3. PIC/S Guide to Good Manufacturing Practice for Medicinal Products (PE 009-1), Sep 1, 2003.
4. WHO expert committee on specifications for pharmaceutical preparations, 32nd report. Good Manufacturing Practices for Pharmaceutical Products (Annex 1). Geneva: World Health Organization, 1992.
5. Pharmaceutical Inspection Co-operation Scheme (PIC/S). <http://www.picscheme.org>.
6. International Conference on Harmonization (ICH). <http://www.ich.org>.
7. International Organization for Standardization (ISO). <http://www.iso.ch>.
8. FDA Guideline for the Format and Content of the Chemistry, Manufacturing, and Controls Section of an Application, Feb 1987.
9. FDA Guideline for Drug Master Files, Sep 1989.
10. FDA Guidance for Industry: Scale-up and Postapproval Changes for Immediate Release Solid Oral Dosage Forms, Nov 1995.
11. Skelly JP, et al. Workshop report: scale up of immediate release oral solid dosage forms. *Pharm Res* 1993; 10(2):313–316.
12. 21 CFR Part 314.70. Supplements and Other Changes to an Approved Application.
13. FDA Guidance for Industry: Scale-up and Postapproval Changes for Modified Release Solid Oral Dosage Forms, Sep 1997.
14. Skelly JP, et al. Workshop report: scale-up of oral extended-release dosage forms. *Pharm Res* 1993; 10(12):1800–1805.
15. FDA Guidance for Industry: Scale-up and Postapproval Changes for Immediate Release and Modified Release Solid Oral Dosage Forms (Manufacturing Equipment Addendum), Jan 1999.
16. Health Sciences Authority (Singapore). Guidance Notes on Preparation of a Site Master File, May 1999.
17. European Commission regulation (EC) No. 1084/2003, Jun 3, 2003.

18. Guideline on Dossier Requirements for Type IA and Type IB Notifications, European Commission, Jul 2003.
19. FDA Guideline on General Principles of Process Validation, May 1987.
20. WHO expert committee on specifications for pharmaceutical preparations, 34th report. Good Manufacturing Practices: Guidelines on Validation of Manufacturing Processes (Annex 6). Geneva: World Health Organization, 1996.
21. Kieffer R, Torbeck L. Validation and process capability. *Pharm Technol* 1998:66–76.
22. FDA Guide to Inspections of Oral Solid Dosage Forms Pre/Post Approval Issues for Development and Validation, Jan 1994.
23. Good Automated Manufacturing Practice Guide (GAMP 4). International Society of Pharmaceutical Engineering (ISPE), Dec 2001. <http://www.ispe.org>.
24. PIC/S Guide to Good Practices for Computerized Systems in Regulated “GXP” Environments (PE 011-1), Aug 20, 2003.
25. 21 CFR Part 11. Electronic Records; Electronic Signatures.
26. FDA Guidance for Industry on Part 11, Electronic Records; Electronic Signatures—Scope and Application, Aug 2003.